

New approaches and best practices for closing the materials cycle in the water sector

Deliverable D1.5

AUTHORS :

A. KLEYBÖCKER, I. KENYERES, E. POOR-POCSI, A. NÄTTORP, L. LOREGGIAN, M. SCHAUB, C. EGLI, M. GROZAVESCU, M. MURARIU, B. RADU, P. SCHEER, R. LINDEBOOM, R. GIURGIU, C. PLATA RIOS, R. SUTERS, J. HEINZE, A. SOARES, P. VALE, J. KIM, A. LANHAM, J. HOFMAN

DATE : 02.01.2023



Technical References

Project Acronym	NextGen
Project Title	Towards a next generation of water systems and services for the circular economy
Project Coordinator	<u>KWR</u>
Project Duration	53 months

Deliverable No.	D1.5
Dissemination level ¹	PU
Work Package	WP1
Task	1.4
Lead beneficiary	KWB
Contributing beneficiary(ies)	KWB, AVA, FHNW, IPSTAR, UCRAN, STW, BIOPOL, WDD, CHEM, NTUA, EYDAP, CoA, WDD, CTU
Due date of deliverable	30.11.2022
Actual submission date	18.11.2022; Revision: 02.01.2023

PU = Public

PP = Restricted to other programme participants (including the Commission Services)

RE = Restricted to a group specified by the consortium (including the Commission Services)

CO = Confidential, only for members of the consortium (including the Commission Services)



Document history

V	Date	Beneficiary/Author	Action
1	19.09.2022	KWB et al., Kleyböcker et al.	Send to internal reviewer Fabian Kraus
2	30.09.2022	KWB, Elisa Rose	Feedback of internal reviewer → Kleyböcker et al.
3	11.10.2022	KWB et al.	Send to external reviewer
4	21.10.2022	KWR, Joep van den Broeke	Feedback of external reviewer → Kleyböcker et al.
5	15.11.2022	KWB et al., Kleyböcker et al.	Send to QA (Sandra Casas & Jos Frijns)
6	16.11.2022	QA	Feedback of QA → Kleyböcker et al.
7	18.11.2022	KWB et al., Kleyböcker et al.	Final version → EC
8	02.01.2023	KWB et al., Kleyböcker et al.	Revised version according to the comments of the reviewer



Update of previous version

Review of NextGen D1.5

The deliverable is well presenting the technologies for material recovery and the case study specific results of those technologies. The reported work is in line with the original task. It is closely linked to D1.3 and D1.4, following a similar structure. Also links to other work packages are specified. The evaluation regarding ease of maintenance, knowledge levels and technology risk is good to see for each case. However, it would be useful to see all cases in a one-page table with conclusions and evaluation data presented. Please update the deliverable accordingly.

Reviewer's comment	Revision	Explanation
It would be useful to see all cases in a one-page table with conclusions and evaluation data presented.	Done	An additional table (Table 5) was inserted after the executive summary as an overview containing the evaluation data (e.g. recovery rates) and the conclusions e.g. indictating the potential of a upscaled (full-scale) system.



Executive summary

NextGen demonstrates and investigates technologies for water reuse, material recovery and energy recovery at ten case studies distributed across Europe. The treatment of wastewater offers synergies via certain technologies, which purify the water for water reuse and simultaneously allow for the recovery of materials/nutrients and/or energy. This deliverable focuses on a modelling task and technologies for material recovery demonstrated in the NextGen project (Figure 1).

Material recovery from sludge

At three case studies in Athens (EL), Altenrhein (CH) and Timișoara (RO), different technologies were investigated to recover materials from sludge at different technology readiness levels (TRL, Table 1).

In Athens, a decentralised solution a so called sewer mining unit was implemented. The excess sludge from the membrane bioreactor was thickened and together with pruning waste composted in a rapid composting bioreactor. The yearly produced amount of compost was 5 t, which was reused on-site. An up-scaled system referring to 600 population equivalents (PE) has the potential to produce 1 t N/a and 0.34 t P/a. This corresponds to 15% and 72% of the N and P loads in the raw wastewater, respectively.

In Altenrhein and Timișoara, pyrolysis processes were tested as a side stream treatment of dried digestate to produce granular activated carbon and pyrolysis gas, oil as well as biochar, respectively. The recovery rates in Altenrhein were 50% GAC and 50% pyrolysis gas and in Timișoara, 18% gas, 2% oil and 63% biochar. The GAC produced from sludge was suitable for a pretreatment to remove micropollutants upstream of a conventional GAC filter to prolong its lifetime. The pyrolysis batch experiments with the sludge originating from Timișoara showed a potential to substitute around 3100 m³ natural gas/d with an up-scaled system.

Table 1 Summary of main outcomes of the case studies dealing with material recovery

	Athens	Altenrhein	Timișoara
Technology	Rapid composting bioreactor (TRL 7)	Pyrolysis (TRL 7)	Pyrolysis (TRL 4)
Product	Compost	Granular activated carbon (GAC)	Gas
Recovery rate	C: 60%; N:80%; P: 100%	50% GAC 50% gas, sieving losses	18% gas, 63% char, 2% oil
Flow rate	5 t compost/a	1 kg dried sludge/h	2.1 kg dried sludge/h
Upscaling or suitability	600 PE: 1 t N/a & 0.34 t P/a	Suitable as pre-treatment for conventional GAC filter	400 000 PE: 3100 m ³ gas/d



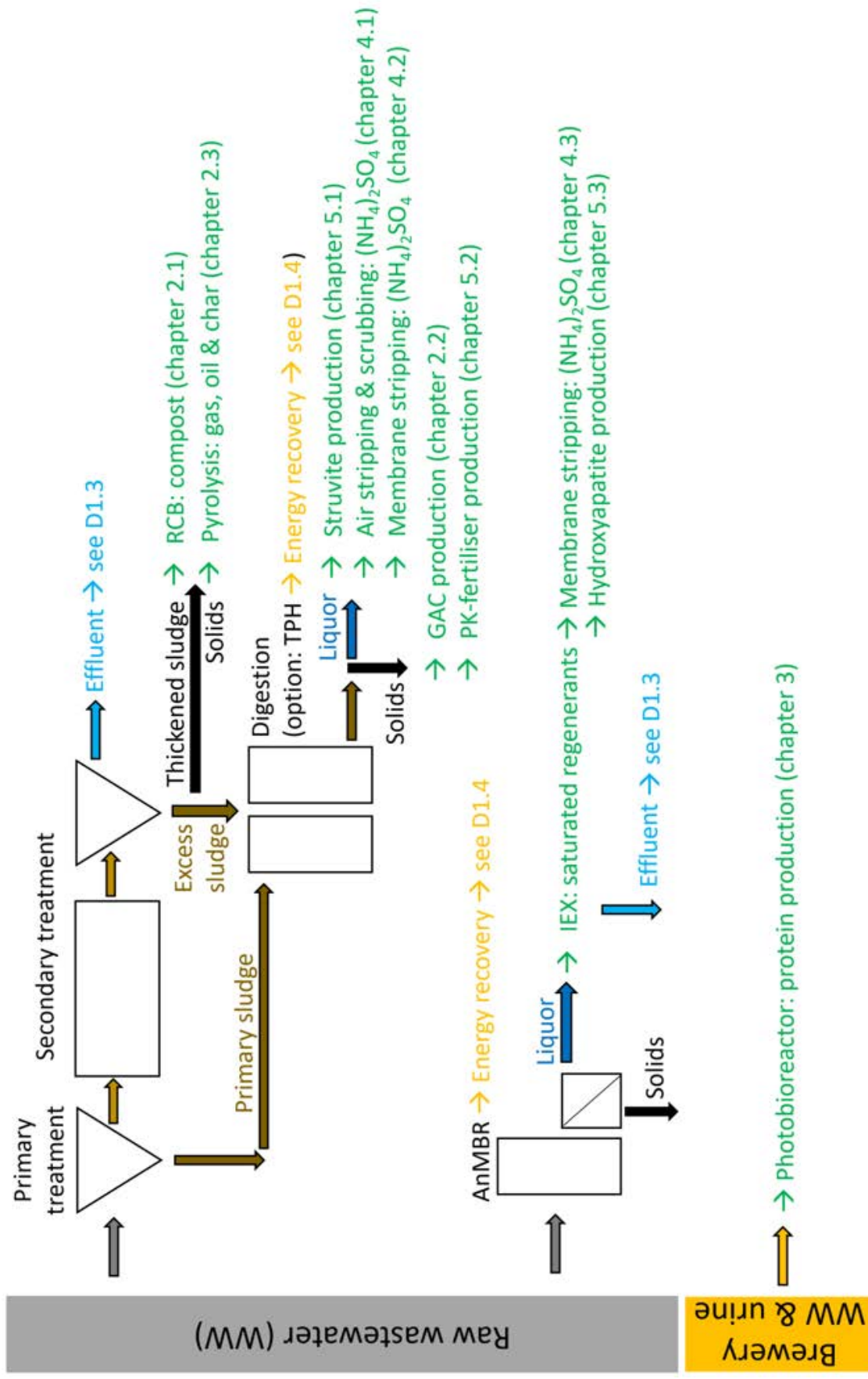

Figure 1 Overview about the different points of application for the NextGen material recovery technologies (AnMBR: anaerobic membrane bioreactor; RCB: rapid composting bioreactor; TPH thermal pressure hydrolysis, GAC granular activated carbon); here: no distinction between centralised and decentralised systems

Protein production from brewery wastewater, urine and/or RO concentrates

In La Trappe (NL), a photobioreactor was demonstrated to treat brewery wastewater and urine in a main stream to produce proteins that can be used as a slow release fertiliser. In general, this technology is also capable to produce proteins that can be used as fodder or even food additive. The TRL of the technology is still low between 5 and 6 and further investigations are needed. The recovery rates were 38% for COD, 20% for N and 25% for P. The photobioreactor produced roughly 0.48 g TSS biomass per litre wastewater. This corresponds to a production of around 276 to 575 kg of dried biomass per year to be used as a slow release fertiliser. In NextGen, the proteins were successfully tested as a slow release fertiliser to grow microgreens. Furthermore, this technology is also very well suited to treat concentrates from membrane treatments.

Table 2 Summary of main outcomes of La Trappe

	La Trappe
Technology	Photobioreactor (TRL 5-6)
Product	Proteins as slow release fertiliser
Recovery rate	COD: 38%; N: 20%; P: 25%
Flow rate	60 L wastewater/d
Suitability	Pilot: 276-575 kg dried biomass/a → Successfully tested to grow microgreens

Nitrogen removal and recovery

Nitrogen removal and recovery was tested at three case studies, in Braunschweig (DE), Altenrhein (CH) and Sernal (UK). The TRL in Sernal reached TRL 6 suggesting, that further investigations are necessary prior to its replication at full-scale (Table 3).

Table 3 Summary of main outcomes of the case studies dealing with nitrogen recovery

	Sernal	Altenrhein	Braunschweig
Technology	IEX & HFMC (TRL 6)	HFMC (TRL 8)	Air stripping & scrubbing (TRL 9)
Product	Ammonium sulphate	Ammonium sulphate	Ammonium sulphate
Recovery rate	N: > 76%; IEX >80%; HFMC >95%	N: 75%	N: 85-97%
Flow rate	1 m ³ AnMBR effluent/d	8.5 m ³ centrate/h	7-19 m ³ liquor/h
Upscaling	100 000 PE: 320 t N/a	305 000 PE: 66 t N/a	380 000 PE: 175 t N/a

The Sernal system was applied in the effluent of an anaerobic membrane bioreactor as a main stream technology. It consisted of an ion exchanger to concentrate the ammonium and a hollow fibre membrane contactor (HFMC) for ammonia stripping and ammonium sulphate



production. The recovery rates for the ion exchanger and the HFMC were higher than >80% and >95%, respectively, resulting in a nitrogen recovery rate higher than >76%. Based on those results, the production of ammonium sulphate in a full-scale system for 100 000 PE is assumed to result in the recovery of 320 t N/a. This corresponds to 88% of the inflow nitrogen load to the WWTP.

In Altenrhein, also a HFMC was tested, however in a side stream for the centrate of dewatered digestate at TRL 8. The recovery rate was 75% in the pilot plant. Hence, the recovery of a full-scale system (305 000 PE) of 66 t N/a can be expected for Altenrhein. This corresponds to 11% of the nitrogen inflow load to the WWTP.

In Braunschweig, a full-scale air stripping and scrubbing system was implemented with a TRL 9. The recovery rates were easy to control and could be operated between 85% and 97% as required. The potential for the production of $(\text{NH}_4)_2\text{SO}_4$ solution under optimised conditions is 2000 t/a corresponding to 175 t N/a, which is 12% of the inflow nitrogen load to the WWTP.

Phosphorus removal and/or recovery

Three different technologies were tested for phosphorus removal and/or recovery. In Sernal, hydroxyapatite was produced as a main stream treatment using the effluent of an anaerobic membrane bioreactor combined with an ion exchanger and a precipitator (Table 4).

Table 4 Summary of main outcomes of the case studies dealing with phosphorus recovery

	Sernal	Altenrhein	Braunschweig
Technology	IEX & precipitation (TRL 6)	Thermal treatment (TRL 8)	CO ₂ stripping & precipitation (TRL 9)
Product	Hydroxyapatite	PK fertiliser	Struvite
Recovery rate	P: > 72%; IEX >80%; precipitator >90%	P: 90-100%	P: 80-97%
Flow rate	1 m ³ AnMBR effluent/d	50 kg dried sludge/h	7-19 m ³ liquor/h
Upscaling	100 000 PE: 61 t P/a	305 000 PE: 260 t P/a	380 000 PE: 37 t P/a & 17 tN/a

The ion exchanger was used to concentrate the phosphate concentration in order to precipitate the phosphate as hydroxyapatite in the subsequent precipitator. A TRL of 7 was reached suggesting to further optimise the system. The recovery rates for the ion exchanger and the precipitator were >80% and > 90%, respectively. Based on those results, a full-scale system (100 000 PE) can recover 61 t P/a, what corresponds to 80% of the P load in the influent of the WWTP.

In Altenrhein, a thermal treatment was tested using dried digestate as side stream technology. Its TRL reached 8 and the recovery rate ranged between 90% and 100%. Since this treatment does only partly remove heavy metals, a detailed characterisation of the feed stream is necessary and an application using “clean” digestate or waste streams from the food industry might be even more beneficial. Using digestate from a municipal WWTP as feed stream, 0.95 kg P/h was achieved in the pilot plant. This corresponds to the recovery of 390 t P/a for a 305 000 PE full-scale plant. Those correspond to 12% of the influent phosphorus load of the WWTP.



In Braunschweig, a struvite production unit was demonstrated at TRL 9. It used the liquor of dewatered digestate in a side stream and reached recovery rates between 80%-97%. The recovery rate depended highly on the chemical composition of the liquor, the mixing conditions in the precipitation reactor and the dosing rates of $MgCl_2$. For a full year of operation and under optimised conditions, the production of 300 t struvite is expected. This corresponds to 16% of the phosphorus influent load and to 1% of the nitrogen influent load to the WWTP.

Dynamic sewer modelling: impact of low-flow wastewater on nutrient concentrations

In Filton Airfield (UK), a circular economy concept shall be implemented on a regional scale in the near future. Therefore, the nutrient concentrations in the potential wastewater were modelled. An important aspect to consider thereby was the dependence of the nutrient concentrations on the type of housing and the installation of water-saving appliances. Using those, the wastewater flow rate decreases and contributes to higher nutrient concentrations in the potential wastewater. Hence, the changes of the nitrogen and phosphorus concentrations vary from 52% to 61% and from 27% to 42%, respectively, depending on the house type (ecohouse with water-saving appliances vs. conventional house). For Filton Airfield, the ion exchanger and the hollow fibre membrane contactor (see case study Spernal), are suggested to be the most appropriate and sustainable solution among the NextGen nutrient recovery technologies, because they can be applied as a decentralised system on a local level as required in Filton Airfield and they profit from a high nutrient concentration in the inflow stream.

Future recommendations and concrete steps for up-scaling to EU level

The TRLs of the technologies reached during the NextGen project mean further development is required before their implementation at full-scale will be possible. Especially with other wastewater compositions than demonstrated in NextGen, even for technologies at TRL 9, pre-tests are needed to better understand the systems. Hence, more demonstrations in different scales are needed to convince new investors. In this way, showing the benefits of nutrient/material recovery and higher effluent qualities against costs and maintenance needs will easily convince them.

The implementation of those technologies will be accelerated, if there are incentives or even pressure from regulations and governments to implement for example nutrient resource recovery technologies. Compared to the fertiliser industry, most nutrient recovery plants in circular economy are small and decentralised. They do not have the logistics and legal knowledge (e.g. REACH & certificate processes) to bring their fertilisers to the market as the fertiliser industry does. Until now, the Fertilising Products Regulation (EU 2021/2086) mentions only “precipitated phosphate salts and derivatives” as renewable fertilisers originating from sewage sludge and wastewater. This means ammonium sulphate, compost and biochar, all originating from sewage sludge or wastewater are not explicitly mentioned in the regulation. A further step is needed to process the recovered materials towards a usable product. Between a fertiliser producer and a farmer for example, there act usually trading companies. They might have an advantage, when they blend the renewable fertilisers with the “traditional fertilisers”.



EU added value of the technologies

NextGen demonstrated and further developed technologies that are in line with the ambitions of the European Green Deal its Action Plan for Circular Economy to reduce strongly the EU greenhouse gas emissions, to provide clean water, maintain healthy soil, make industry resilient and produce cleaner energy.

The collection and open access presentation of the technologies and the results presented in this deliverable, together with the other project results such as the technology evidence base (D1.7, Kleyböcker et al. 2022), will support decision makers and investors to gain a fast overview about the opportunities and proven concepts of circular economy. Together with the Marketplace (D5.5), the technology evidence base will contribute to the transition from a linear to a circular economy in Europe.

Table 5 provides a short summary and overview about the achieved results, evaluation data and conclusions for each NextGen case study related to material recovery.



Table 5 Overview about material recovery at the relevant NextGen case studies and their results and conclusions

Material recovery technologies and produced materials in NextGen					
Case study	Technology/Method	Product	Recovery rates/evaluation data	Upscaling/conclusion	
Material recovery from sludge	Athens (EL)	Compost	C: 60%; N:80%; P: 100%	600 PE: 1 t N/a & 0.34 t P/a	
	Altenrhein (CH)	Renewable granular activated carbon	50% GAC 50% gas, sieving losses	Suitable as pre-treatment for conventional GAC filter	
	Timișoara (RO)	Biochar, gas & oil	18% gas, 63% char, 2% oil	400 000 PE: 3100 m³ gas/d	
Protein production from wastewater	La Trappe (NL)	Protein-based slow release fertiliser and fodder	COD: 38%; N: 20%; P: 25%	Pilot: 276-575 kg dried biomass/a → successfully tested to grow microgreens	
	Braunschweig (DE)	Air stripping & scrubbing (TRL 9)	N: 85-97%	380 000 PE: 175 t N/a	
Nitrogen removal and recovery	Altenrhein (CH)	Ammonium sulphate	N: 75%	305 000 PE: 66 t N/a	
	Spernal (UK)	Ion exchanger & membrane stripping (TRL 6)	N: > 76%; IEX >80%; HFMC >95%	100 000 PE: 320 t N/a	
	Braunschweig (DE)	CO ₂ stripping & precipitation of struvite (TRL 9)	P: 80-97%	380 000 PE: 37 t P/a & 17 tN/a	
Phosphorus removal and recovery	Altenrhein (CH)	PK fertiliser	P: 90-100%	305 000 PE: 260 t P/a	
	Spernal (UK)	Hydroxyapatite	P: > 72%; IEX >80%; precipitator >90%	100 000 PE: 61 t P/a	
Nutrient concentrations in future WW streams	Filton Airfield (UK)	Concentrations of nutrients in future WW for recovery	Increase in N & P concentrations due to water saving appliances: N: 52-61% & P: 27-42%	Best suited NextGen system: Ion exchanger, membrane stripping and hydroxyapatite precipitation	

Disclaimer

This publication reflects only the author's views and the European Union is not liable for any use that may be made of the information contained therein



Table of Contents

<u>TECHNICAL REFERENCES</u>	<u>2</u>
<u>DOCUMENT HISTORY</u>	<u>3</u>
<u>EXECUTIVE SUMMARY</u>	<u>4</u>
<u>DISCLAIMER</u>	<u>12</u>
<u>TABLE OF CONTENTS</u>	<u>13</u>
<u>LIST OF FIGURES</u>	<u>14</u>
<u>LIST OF TABLES</u>	<u>18</u>
<u>ACRONYMS</u>	<u>21</u>
<u>1. INTRODUCTION</u>	<u>23</u>
<u>2. MATERIAL RECOVERY FROM SLUDGE</u>	<u>26</u>
2.1 RAPID COMPOST PRODUCTION IN ATHENS (EL)	26
2.2 GRANULAR ACTIVATED CARBON PRODUCTION IN ALTENRHEIN (CH)	41
2.3 BIOCHAR, OIL AND GAS PRODUCTION VIA SLUDGE PYROLYSIS IN TIMIȘOARA (RO)	60
<u>3. PROTEIN PRODUCTION FROM WASTEWATER</u>	<u>75</u>
<u>4. NITROGEN REMOVAL AND RECOVERY</u>	<u>93</u>
4.1 AMMONIUM SULPHATE PRODUCTION VIA AIR STRIPPING AND SCRUBBING IN BRAUNSCHEWIG (GER)	93
4.2 AMMONIUM SULPHATE PRODUCTION VIA MEMBRANE STRIPPING IN ALTENRHEIN (CH)	103
4.3 AMMONIUM SULPHATE PRODUCTION VIA ION EXCHANGE AND HOLLOW FIBRE MEMBRANE CONTACTOR IN SPERNAL (UK)	116
<u>5. PHOSPHORUS REMOVAL AND RECOVERY</u>	<u>127</u>
5.1 STRUVITE PRODUCTION IN BRAUNSCHEWIG (GER)	127
5.2 PK-FERTILISER PRODUCTION IN ALTENRHEIN (CH)	139
5.3 HYDROXYAPATITE PRODUCTION IN SPERNAL (UK)	146
<u>6. DYNAMIC SEWER MODELLING: IMPACT OF LOW-FLOW LOCAL WASTEWATER ON NUTRIENT CONCENTRATIONS</u>	<u>156</u>
<u>7. DISCUSSION AND CONCLUSIONS</u>	<u>179</u>
7.1 BENEFITS AND CHALLENGES OF THE TECHNOLOGIES	179
7.2 BEST APPLICATIONS OF THE TECHNOLOGIES	181
7.3 TRANSFERABILITY: APPLICATION AT OTHER SITES	188
7.4 RECOMMENDATIONS FOR FUTURE IMPLEMENTATIONS	191
<u>8. LITERATURE REFERENCES</u>	<u>193</u>



List of Figures

Figure 1	Overview about the different points of application for the NextGen material recovery technologies (AnMBR: anaerobic membrane bioreactor; RCB: rapid composting bioreactor; TPH thermal pressure hydrolysis, GAC granular activated carbon); here: no distinction between centralised and decentralised systems 6	6
Figure 2	Infographic illustrating the three cycles of water, nutrients/material and energy to be closed by the circular economy related technologies developed and demonstrated in NextGen 23	23
Figure 3	Example for windrow composting (Alamy Stock Photo) 28	28
Figure 4	Example for in-vessel composting (google images) 29	29
Figure 5	RCB implemented in Athens (image: Zoltán Csipai) 29	29
Figure 6	Overall scheme of the RCB in Athens 30	30
Figure 7	RCB under construction in Athens at the Tree Nursery 31	31
Figure 8	Left: Deformed mixing arm; middle: adjusted design of the mixing organ; right: new mixing organ 34	34
Figure 9	Scheme of the RCB showing the mixing device before (on the left) and after optimisation (in the middle) and finally, the new optimised mixing device (on the right) 35	35
Figure 10	Mixing arm with further improvements 35	35
Figure 11	Readjustment of the existing elements of the mixing arm 36	36
Figure 12	Reinforcement of mixing arm by double welding in two positions 36	36
Figure 13	1-small capacity fine shredder; 2-testing different shredder for wood waste; 3-shredded and screened wood waste mixture; 4-mixing test with compost raw material; 5-wood waste fractionation; 6-sludge thickening with filter bags; 7-testing different premixes of shredded wood waste and thickened sludge; 8-raw feed material to rapid composting 37	37
Figure 14	Flow scheme of the pyrolysis and activation processes integrated in the sewage sludge management of WWTP Altenrhein 44	44
Figure 15	Flow scheme of the PYREKA research pyrolysis and activation unit (Pyreg GmbH, Dörth, Germany) at Agroscope (Reckenholz, Switzerland) 44	44
Figure 16	Flow scheme of the ozonation and GACs pilot plant at WWTP Altenrhein as tertiary treatment for municipal wastewater 44	44
Figure 17	Pictures of the PYREKA research pyrolysis and activation unit (Pyreg GmbH, Dörth, Germany) at Agroscope (Reckenholz, Switzerland) on the left panel, and the pilot scale GAC contactors at WWTP Altenrhein on the right panel. 45	45
Figure 18	Ash content in GAC _{SS} activated with steam, and CO ₂ , in GAC _{CP} activated with steam, and CO ₂ , as well as in GAC _{Ref} 46	46
Figure 19	Hardness in GAC _{SS} activated with steam, and CO ₂ , in GAC _{CP} activated with steam, and CO ₂ , at different temperature (left panel), residence time (central panel), and percentage of activating agent (right panel). 47	47
Figure 20	Active surface (Brunauer -Emmet-Teller, BET) in GAC _{SS} activated with steam, and CO ₂ , in GAC _{CP} activated with steam, and CO ₂ at different temperature (left panel), and residence time (right panel), summary of surface measurements of the 21 GACs samples 47	47



Figure 21	Comparison of single-solute adsorption isotherm for Amisulpride, Citalopram, Metoprolol, Benzotriazole, Irbesartan, and Candesartan.	48
Figure 22	Losses of GAC from the commercial GAC (C401V), and the two renewables GACs over the entire operation of the pilot experiment.....	50
Figure 23	Elemental concentrations of major elements over time in renewable GAC _{SS} ...	51
Figure 24	Elimination of selected micropollutants ordered from those with the highest affinity	54
Figure 25	Relative abundances of some bacterial phyla in biofilm from cherry pit GAC (CP) and conventional GAC (Chemviron 401V).....	55
Figure 26	Results from thermal Gravimetry analysis of GAC _{Ref} (C401V), GAC _{SS} , and GAC _{CP} over time	56
Figure 27	a) Hardness of Fresh GAC _{SS} and GAC _{CP} , spent GAC _{SS} and GAC _{CP} , and regenerated GAC _{SS} and GAC _{CP} using 10, 20 and 50% activating agent. b) Particles size distribution of fresh GAC _{SS} , spent GAC _{SS}	57
Figure 28	Scheme of the lab-scale TCR [®] plant	63
Figure 29	Lab-scale TRC [®] plant.....	64
Figure 30	Left: feedstock before pelletising; right: pelletised sludge.....	65
Figure 31	Mass balance (values given in mass-%).....	66
Figure 32	Gas compositions resulting from gas chromatography	68
Figure 33	Overview of Micro-Ecological Life Support System Alternative (MELiSSA) Lasseur et al. 2011.....	77
Figure 34	Flow scheme of a MELiSSA inspired purple bacteria reactor (Alloul et al. 2021b)	79
Figure 35	Pictures of the axenic MELiSSA purple bacteria reactor (Giurgiu et al. 2020)..	79
Figure 36	Flow scheme of the NextGen technologies at the case study in La Trappe	79
Figure 37	Evolution of TCOD and SCOD in the reactor in the second week of operation in the raceway reactor. TCOD _{inf} is the influent concentration in the reactor (Alloul et al. 2021a).....	82
Figure 38	Evolution of total nitrogen (TN) ammonium (SNH ₄) and Phosphate (PO ₄) in the raceway reactor in the second week of operations in the phase 2.....	83
Figure 39	Expected trends of NH ₄ and NO ₃	88
Figure 40	Advanced reactor proposed by TU Delft students.....	91
Figure 41	Flow scheme of the ammonium sulphate production unit	95
Figure 42	Pictures of the ammonium sulphate production units, the storage tank and an ammonium sulphate solution sample.....	95
Figure 43	Nitrogen recovery rates reach their expected range at 85% and higher with different operating conditions in pH and temperature	97
Figure 44	Chemical composition of the ammonium sulphate solution (n= 20 samples) compared to the legal requirements of the German fertiliser regulation (DüMV 2012).....	97
Figure 45	Concentrations of N and Hg in the effluent from the struvite production unit compared to the concentrations in the ammonium sulphate solution units....	98
Figure 46	Left: HFMC in Altenrhein; right: flow scheme of the HFMC	105
Figure 47	Flow scheme of the ammonia stripping plant in Altenrhein	106
Figure 48	Ammonia concentration evolution over time in the fertiliser.....	107
Figure 49	Simplified diagramme showing the concentration unit	108
Figure 50	Evolution the centrate quality over time	110



Figure 51 Removed fraction of nitrogen in total and by the membranes 112

Figure 52 Location of the Sernal wastewater treatment plant (WWTP) within the United Kingdom (left) and local map (right). 116

Figure 53 Areal picture showing the Urban Strategy Demonstration Site at Sernal WWTP and the location where the NextGen demonstrator was built..... 117

Figure 54 Areal picture showing the NEXT-GEN demonstrator including the anaerobic membrane reactor and degassing unit (top) and the schematic representation of the process (bottom). 117

Figure 55 Schematic representation of the ion exchange plant for ammonia and phosphorus removal and recovery (top) and pictures of the technology at Cranfield University (middle) and ammonia recovery technology (bottom) .. 120

Figure 56 Influent and effluent ammonia concentrations during operation of IEX demonstration plant 121

Figure 57 Ammonia concentration in the treated brine and the NH₃ recovery efficiency by HFMC 123

Figure 58 Flow scheme of the struvite production unit (NuReSys process) 130

Figure 59 Pictures of the struvite production unit consisting of a CO₂ stripping unit, a struvite reactor, a settler and a container to collect the harvested struvite crystals (NuReSys process). 130

Figure 60 Phosphorus recovery rate referring to the total phosphorus (TP) and phosphate removal rate referring to dissolved phosphate (PO₄-P)..... 131

Figure 61 Phosphorus recovery rate referring to the total phosphorus (TP), pH and MgCl₂ dosing rate: after 900 days high recovery rates were reached with optimal operating conditions 132

Figure 62 Case study Braunschweig: phosphorus recovery rates depending on the molar ratio of Mg:P: for Mg:P > 0.8 the expected recovery rates are always reached; no correlation observed for N:P..... 133

Figure 63 Chemical composition of the produced struvite of n=4 samples: the P content complies with the German fertiliser regulation (DüMV 2012) and labelling is only required for the main nutrients. 133

Figure 64 Contents of heavy metals in the produced struvite (n= 4 samples): according to the German fertiliser ordinance (DüMV 2012) no labelling of heavy metals are required 134

Figure 65 Flow scheme of the pilot plant for PK fertiliser production..... 141

Figure 66 Front and side view of the pilot unit (picture owner: CTU) 141

Figure 67 PK-fertiliser (picture owner: FHNW) 141

Figure 68 Plant availability of PK fertiliser from lab trials and pilot trial in 2020. 142

Figure 69 Location of the Sernal wastewater treatment plant (WWTP) within the United Kingdom (left) and local map (right). 146

Figure 70 Areal picture showing the Urban Strategy Demonstration Site at Sernal WWTP and the location where the NextGen demonstrator was built..... 147

Figure 71 Areal picture showing the NEXT-GEN demonstrator including the anaerobic membrane reactor and degassing unit (top) and the schematic representation of the process (bottom). 147

Figure 72 Schematic representation of the ion exchange plant for ammonia and phosphorus removal and recovery (top) and pictures of the technology at Cranfield University (middle) and ammonia recovery technology (bottom) .. 149



Figure 73 Influent and effluent PO₄-P concentrations during operation of IEX demonstration plant. 151

Figure 74 Location of Filton Airfield and Filton Airfield master plan 156

Figure 75 Map of the Hanger District development with different housing types adapted from YTL Developments Master plan. Housings with grey colour are not included for this study..... 159

Figure 76 The start page of Water-Use Info, consisting of a tool to generate a spg-file for residential water use and a button to install the SIMDEUM Pattern Generator. 160

Figure 77 The home screen for the SIMDEUM pattern generator user-friendly interface 161

Figure 78 Sewer network overlaid onto housing map (SWMM) 162

Figure 79 Cross-sectional view of the sewer network from highest to outfall (lowest) point 162

Figure 80 Daily trend of all age groups sleeping (o, blue) and away from home (*, orange).. 163

Figure 81 Installation and consumption of Water-Use Info in Watershare (<http://www.watershare.eu/>)..... 165

Figure 82 Household statistics data – an example of two-bedroom house 168

Figure 83 Outline of simulation procedure 169

Figure 84 Occupancy for each house type (apartment and free-standing house)..... 169

Figure 85 Wastewater flowrate at network outfall for a 5-day period. NA: Normal appliances, WSA: Water saving appliances..... 170

Figure 86 Flowrate of wastewater comparing normal household appliances and water saving household appliances. NA: Normal appliances, WSA: Water saving appliances. Morning - 6:30am-9:30am, Evening - 4:30pm-11:30pm. 170

Figure 87 Average flowrate over the morning period (6:30am-9:30am) for each day. NA: Normal appliances, WSA: Water saving appliances..... 171

Figure 88 5-weekday simulation results of (a) nitrogen, N, and (b) phosphorous, P. NA: Normal appliances, WSA: Water saving appliances..... 172

Figure 89 Wastewater phosphorus concentration comparing normal household appliances and water saving household appliances. 173

Figure 90 Average phosphorous concentration over the morning period for each day. NA: Normal appliances, WSA: Water saving appliances..... 173

Figure 91 Overview about the different points of application for the NextGen material recovery technologies 182

Figure 92 NextGen technologies for material recovery from sludge with dry matter (DM) contents of their inflow streams 183

Figure 93 Photobioreactor with influent concentrations of COD, TN and TP..... 184

Figure 94 Overview about the nitrogen recovery technologies with influent NH₄-N concentrations in NextGen 186

Figure 95 Phosphorus recovery technologies in NextGen with feed concentrations or contents..... 187



List of Tables

Table 1	Summary of main outcomes of the case studies dealing with material recovery ..	5
Table 2	Summary of main outcomes of La Trappe	7
Table 3	Summary of main outcomes of the case studies dealing with nitrogen recovery ..	7
Table 4	Summary of main outcomes of the case studies dealing with phosphorus recovery	8
Table 5	Overview about material recovery at the relevant NextGen case studies and their results and conclusions	11
Table 6	Overview about the NextGen technologies for material recovery and their products	24
Table 7	Action and case study objective regarding material recovery in Athens	27
Table 8	Requirements and operating conditions for the RCB	32
Table 9	Key performance indicators of the RCB	38
Table 10	CAPEX and OPEX of the RCB in Athens	38
Table 11	Action and objective regarding GAC production in Altenrhein	42
Table 12	Operating conditions, feedstock and activating agent for GAC production	45
Table 13	Freundlich adsorption capacity parameter (K_F) ($\mu\text{g}/\text{mg}$) (L/mg) ^{1/n} , Freundlich adsorption intensity parameter ($1/N$) (unitless), and R-squared (R^2) for Amisulpride, Citalopram, Metoprolol, Benzotriazole, Irbesartan, and Candesartan adsorption onto Cyclecarb 401V, GAC_{SS} , and GAC_{CP}	47
Table 14	Geometry of the columns	48
Table 15	Operational phases, conditions and duration of phases in bed volumina. The number of treated volumina were calculated using the time dependent bed volumina	48
Table 16	Amount of GACs at start and after operational losses	49
Table 17	Concentrations of different parameters in GAC, mass losses and concentrations in effluent	49
Table 18	GAC_{SS} filter average elimination	53
Table 19	GAC_{CP} filter average elimination	53
Table 20	Comparison of properties and performance of renewable GAC (SS=sewage sludge; CP=cherry pits) and conventional GAC	58
Table 21	Comparison of conventional operating conditions with NextGen optimised conditions	59
Table 22	Action and objective regarding material recovery in Timișoara	61
Table 23	Feedstock characterisation	65
Table 24	Experimental parameters	65
Table 25	TCR-char characterisation	66
Table 26	TCR-oil characterisation	67
Table 27	Gas composition from gas analyser (note: GC results in Figure 32 are more reliable)	67
Table 28	Energy balance of first and last experiment	68
Table 29	Current situation (baseline) without any measures identified in NextGen	69
Table 30	Expected outputs for the Timișoara WWTP due to the planned implementation of the NextGen measures based on the results from the pyrolysis batch tests	70
Table 31	Characteristics of brewery wastewater	75



Table 32	Action and case study objective for protein production in NextGen	78
Table 33	Requirements and operating conditions for purple bacteria in pond reactor system	80
Table 34	Settings of the reactor	80
Table 35	Technical efficiency parameters for the photobioreactor also called raceway reactor	81
Table 36	Total COD removal efficiency calculated between influent and effluent samples. The table reports average weekly variation.	81
Table 37	Volumetric rate (rs), apparent removal efficiency η_s and absolute rate (Rs) of the reactor (100L) operated with a HRT (3 days).....	83
Table 38	Total biomass concentration in the effluent; COD _b =COD biomass; COD _{rem} =COD removed	84
Table 39	Volumetric rate (rs), apparent efficiency removal η_s , and absolute rate (Rs) of the reactor (100L) operated with a HRT (3 days). These values were estimated from the samples RR1 and EFF	85
Table 40	Substrate influence on plant yield	87
Table 41	Fertiliser treatments applied to the microgreen and their influence on the yield	87
Table 42	Hazard Analysis Critical Control Point for ready to use food in the experiments 1 and 2 for the plants inoculated with the purple bacteria, versus the plants grown with synthetic, according with the EFSA regulations	89
Table 43	Heavy metal content in microgreen harvested in both experiments in different substrates (C-cellulose and J-jute) with and without PNSB.....	89
Table 44	KPIs for protein production in La Trappe.....	90
Table 45	Crucial operating parameters for the photobioreactor: ranges for the best results	92
Table 46	Action and case study objective in Braunschweig regarding ammonia recovery	94
Table 47	Requirements and operating conditions for ammonium sulphate solution production.....	96
Table 48	Crucial parameters to evaluate the nitrogen related processes after implementation of the NextGen technologies	99
Table 49	Quality parameters of the ammonium sulphate solution	100
Table 50	Crucial operating parameters for the ammonium sulphate production process: ranges for the best results	102
Table 51	Requirements and operating conditions	106
Table 52	Summary of the main exploitation parameters monitored during 6 weeks of operations.	108
Table 53	Average runtimes of the plant over the 51 days	109
Table 54	Encountered technical problems and solutions	111
Table 55	Characteristics of the Altenrhein plant, characteristics of the Yverdon plant (first plant delivered by Alpha) and estimated future performance of the Altenrhein plant	113
Table 56	Best results were obtained with the presented operating conditions.....	115
Table 57	Required operating conditions of the IEX process for nutrient removal and recovery	121
Table 58	IEX media for ammonia removal and exchange capacity from other studies....	122
Table 59	Ammonia concentrations in regenerant at the end of each regeneration	122
Table 60	EDX analysis of the recovered ammonia product.....	123



Table 61	Base case: Sernal WWTP flow rates, standard influent and effluent parameters 124	
Table 62	Effluent quality – potential water for re-use produced in the base case and NextGen	125
Table 63	Action and case study objective in Braunschweig regarding struvite production 128	
Table 64	Requirements and operating conditions for the struvite production unit.....	131
Table 65	Crucial parameters to evaluate the phosphorus related processes after implementation of the NextGen technologies	135
Table 66	Quality parameters of the struvite crystals	136
Table 67	Crucial operating parameters for the struvite production process: ranges for the best results.....	138
Table 68	Action and case study objective of the PK-fertiliser production in Altenrhein ...	140
Table 69	Operating conditions	142
Table 70	Comparison of NextGen with baseline situation via key performance indicators 143	
Table 71	Example of contaminant profile of PK-fertiliser.	143
Table 72	Action and case study objective for phosphorus recovery in Sernal	148
Table 73	Required operating conditions of the IEX process for nutrient removal and recovery	150
Table 74	IEX media for phosphate removal and exchange capacity from other studies...	151
Table 75	Phosphate concentrations in regenerant at the end of each regeneration.....	152
Table 76	Pathogens, metals and organics analysis of hydroxyapatite recovered from saturated regenerant	152
Table 77	Base case: Sernal WWTP flow rates, standard influent and effluent parameters 153	
Table 78	Effluent quality – potential water for re-use produced in the base case and NextGen	154
Table 79	Main task regarding material recovery in Filton Airfield	157
Table 80	Summarised time budget data for the UK.	164
Table 81	Appliance specific pollutant concentrations.....	166
Table 82	Impact of wastewater profile variations on nitrogen and phosphorous concentrations	175
Table 83	Summary of the crucial parameters for material recovery from sludge in NextGen 183	
Table 84	Summary of the crucial parameters for protein production	184
Table 85	Overview about the crucial parameters of the nitrogen recovery technologies	185
Table 86	Overview about the crucial parameters for phosphorus recovery in NexGen...	187



Acronyms

AD	Anaerobic digestion
AnMBR	Anaerobic membrane bioreactor
AVA	WWTP Althenrhein
BAC	Biological activated carbon
BET	Brunauer-Emmet-Teller
BJH	Barret-Jower-Halenda
BOD	Biological oxygen demand
BV	Bed volumina
CAPEX	Capital expenditures
CE	Circular economy
CFU	Colony Forming Units
COD	Chemical oxygen demand
CP	Cherry pits
DM	Dry matter
DOC	Dissolved organic carbon
DS	Dry solids
EBCT	Empty bed contact time
EDX	Energy-dispersive X-ray spectroscopy
EFF	Removal efficiency
GAC	Granular activated carbon
GC	Gas chromatograph
GHG	Greenhouse gas
HAIX	Hybrid anion exchanger
HFMC	Hollow fibre membrane contactor
HFO-NP	Hydrous ferric oxide nanoparticles
HHV	Higher heating value
HRT	Hydraulic retention time
H ₂ SO ₄	Sulphuric acid
IEX	Ion exchanger
K ₂ O	Potassium oxide
KPI	Key performance indicator
MBR	Membrane bioreactor
MNR	Metabolic network reactor
NA	normal appliances
NaOH	Sodium hydroxide
NF	Nanofiltration
(NH ₄) ₂ SO ₄	Ammonium sulphate
N ₂ O	Nitrous oxide
oDM	Organic dry matter
OMP	Organic micro-pollutants
OPEX	Operational expenditures
PE	Population equivalent
RCB	Rapid compost bioreactor
SEM	Scanning electron microscope



SMU	Sewer mining unit
SPG	SIMDEUM pattern generator
SS	Sewage sludge
SSW	Surface water system
SWMM	Storm water management model
TKN	Total Kjeldahl nitrogen
TN	Total nitrogen
TOC	Total organic carbon
TP	Total phosphorus
TPH	Thermal pressure hydrolysis
TRL	Technology readiness level
TS	Total solids
TSS	Total suspended solids
UF	Ultrafiltration
UV	Ultraviolet
VS	Volatile solids
WIRC	Water Innovation and Research Centre
WP	Work package
WSA	Water saving appliances
WW	Wastewater
WWTP	Wastewater treatment plant
XRD	X-ray diffraction



1. Introduction

NextGen aims to develop and demonstrate circular economy technologies in the water sector. Those innovative technologies contribute not only to close the water cycle, moreover, they also close the material and energy cycles as shown in Figure 2. Therefore, within 53 months, those technologies were designed, constructed and tested at nine case studies in Europe: Braunschweig (DE), Costa Brava (ES), Westland (NL), Altenrhein (CH), Sernal (UK), La Trappe (NL), Gotland (SE), Athens (EL) and Timișoara (RO). In addition, a dynamic sewer modelling study was conducted for the airfield in Filton (UK) to determine the impact of low-flow wastewater on nutrient concentrations and the suitability of the investigated NextGen technologies for this case.

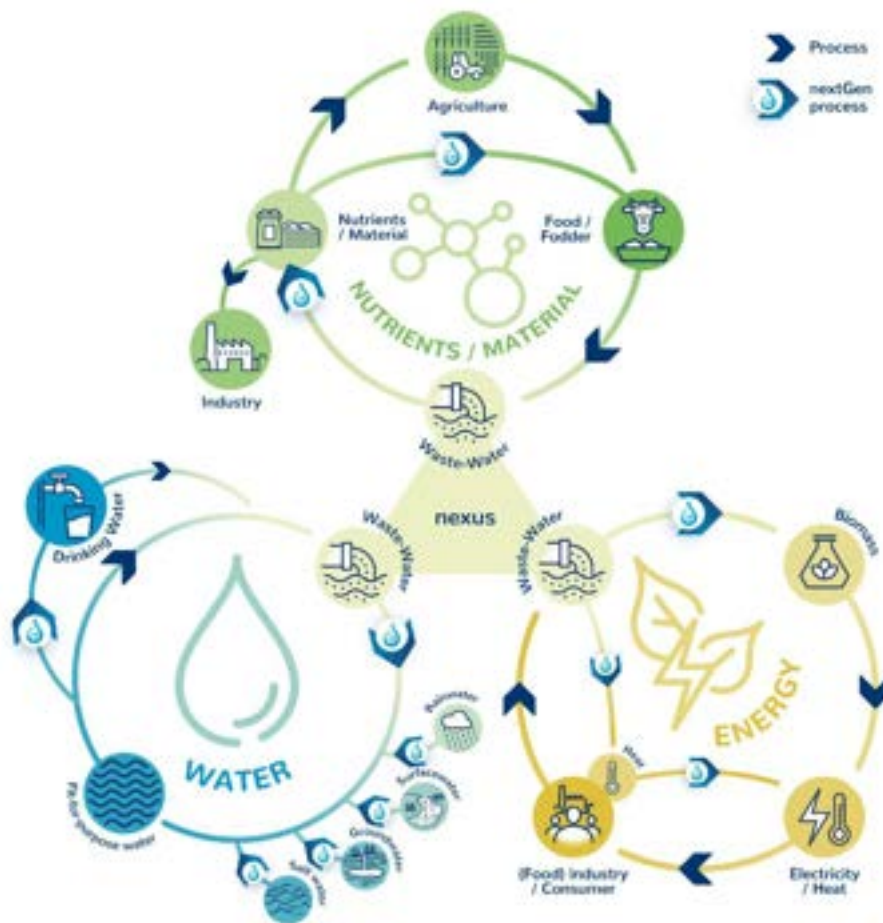

Figure 2 Infographic illustrating the three cycles of water, nutrients/material and energy to be closed by the circular economy related technologies developed and demonstrated in NextGen

This deliverable presents the different NextGen technologies for material recovery and the case study specific results of those technologies. In addition, the strategies to valorise materials from wastewater streams to replace conventional resources are shown. D1.5 compares the baseline situation to the NextGen implemented situation and discusses the challenges and recommendations for future replications of those technologies. Table 6 provides an overview about the developed technologies and their produced materials for the involved case studies. Detailed information about the baseline conditions of all case studies



can be also found in *D1.1 Assessment of baseline conditions for all demo cases* (Kleyböcker et al. 2019).

Table 6 Overview about the NextGen technologies for material recovery and their products

Material recovery technologies and produced materials in NextGen			
	Case study	Technology	Recovered material
Material recovery from sludge	Athens	Rapid composting	Compost
	Altenrhein	Pyrolysis	Renewable granular activated carbon
	Timișoara	Pyrolysis	Biochar, gas & oil
Protein production from wastewater	La Trappe	Photobioreactor	Protein-based slow release fertiliser and fodder
Nitrogen removal and recovery	Braunschweig	Air stripping & scrubbing	Ammonium sulphate solution
	Altenrhein	Membrane stripping	Ammonium sulphate solution
	Spernal	Ion exchanger & membrane stripping	Solid ammonium sulphate
Phosphorus removal and recovery	Braunschweig	CO ₂ stripping & precipitation of struvite	Struvite
	Altenrhein	Thermal treatment	PK fertiliser
	Spernal	Ion exchanger & precipitation of hydroxyapatite	Hydroxyapatite
Nutrient concentrations in future WW streams	Filton Airfield	Dynamic sewer modelling	Concentrations of nutrients (N, P) in future WW to consider recovery

This deliverable is one of three deliverables summarising the results from the technological work package (WP1) of NextGen. It is closely connected to *D1.3 New approaches and best practices for closing the water cycle* (Plana Puig et al. 2022) and *D1.4 New approaches and best practices for closing the energy cycle* (Kim et al. 2022), because some of the technologies contribute to the closure of more than only one cycle regarding water, material and energy.

The results of the three deliverables are the basis for the economical (D2.2) and environmental assessments (D2.1) in WP2 of the NextGen solutions, the microbial risk assessments regarding human health for water reuse and the chemical risk assessments for applying the renewable fertilisers (D2.1). The discussion of the replication opportunities and recommendations regarding the future replication opportunities provides input for WP5.



To further disseminate the results, non-official deliverables per case study summarise the outcomes of the deliverables D1.3, D1.4 and D1.5. They will be accessible via the Water Europe Marketplace at the case study section: <https://mp.uwmh.eu/l/CaseStudy/>.



2. Material recovery from sludge

2.1 Rapid compost production in Athens (EL)

Authors: István Kenyeres (Biopolus), Erzsébet Poór-Pócsi (Biopolus)

2.1.1 Description of the demo site

Athens is a city of 4 million citizens, thus it suffers from great urbanisation issues such as heat island effects, high energy demands in the summer due to extreme heat events, and emerging water scarcity issues. The Athens demo application is located in an area called Athens Plant Nursery, which is part of the Goudi Park, an area in the process of redevelopment and regeneration to become one of the key Metropolitan parks of the capital. The area, which lies in the heart of Athens, is a mixed-use area, comprising of urban green and urban agriculture spaces as well as administration and residential uses. The regeneration is an effort to boost both the local economy and improve quality of life for the citizens of the Attica Region.

The Plant Nursery belongs to the Municipality of Athens and covers an area of approximately 39 ha, of which 16 ha are used in the production, development and maintenance of the plants while the rest are used for general purposes such as administration building and offices of the Municipality of Athens. The Nursery supplies all urban parks and green spaces of Athens with plant material and uses potable water from Athens's Water Supply and Sewerage Company (EYDAP) for its irrigation. Furthermore, the nursery is the staging area for all of the pruning waste from all of the Athens urban green spaces. The green waste is not treated, only stored on site. Over time a part of the green waste is transferred to the Athens landfill. At the same time, the Nursery uses fertilisers supplied by the local market. With regards to the energy needs, the Nursery gets electrical energy from the urban network and for heating they use petrol oil. In this respect, the city seeks alternative water sources to achieve environmental, social and financial benefits to address the water scarcity matters through autonomous and decentralised water systems.

2.1.2 Motivation of implementing circular economy solutions in the water sector

The summers in Athens are hot and dry. Recent studies show increasing tendency towards drier conditions, with increased variability of extreme rainfall events (Founda et al. 2022). Overall precipitation is expected to decrease as longer dry spells and reduced rainfall intensity has been observed. Temperatures are projected to increase in the Athens area in the order of 7-8 °C by 2030. With the longer, hotter, drier summers, green areas are more important than ever to reduce the urban heat island effect. Lush green parks also create a positive environment for both the citizens and the local wildlife. Access to blue green urban spaces has positive effects on the mental and physical health of urban citizens. The green spaces also help provide homes for wildlife. However, green areas require both water and nutrients to remain healthy and vibrant. Athens currently lacks adequate nutrient rich soil, and the reduced rainfall and drier conditions mean more irrigation is required to keep green areas lush.

This situation has led to an increased interest to explore alternative solutions to reduce waste and resource usage. The dominant behaviour of 'take-make-consume-dispose', which



assumes that resources are abundant, available and competitive to dispose of needs to be eliminated and ‘circular economy’ principles and technological innovation should be embraced.

The Athens NextGen solution demonstrates how, through sewer mining, heat recovery and rapid composting, wastewater can be extracted locally from sewers to be treated and further processed, along with green wastes, to create valuable sustainably sourced resources that can be used to nurture Athens green spaces. The solution is in line with the Athens Resilient Strategy for a circular approach to water services by 2030 (City of Athens 2017).

2.1.3 Action and case study objective

Table 7 Action and case study objective regarding material recovery in Athens

Case Study number & name	Sub-task	Technology baseline	NextGen intervention in circular economy for water sector	TRL	Capacity	Quantifiable target
#8 Athens, Greece	Sub-Task 1.4.10.	Compost-based eco-engineered growing media products via Rapid Composting Bioreactor	Test and use down-scaled, decentralised, controlled environment rapid composting bioreactors to produce high quality fertiliser from locally available green waste and sludge.	TRL 4 → 6	100 kg/week	Compost obtained from organic materials of pruning waste and wastewater sludge used as onsite fertiliser.

2.1.4 Unique selling points

The NextGen solutions work to replace existing value chains (drinking water & fertiliser) with upcycled waste chains (green waste, wastewater, and sludge) to create a circular and sustainable solution for Athens green spaces.

Unique selling points for the implementation of the rapid composting unit are:

- ✓ 5-times faster than conventional composting
- ✓ Down-scaled, closed system for controlled composting for precise product (compost) production
- ✓ Integrated with a heat recovery unit with added temperature boosting option
- ✓ Integrated with sewer mining unit for local, direct supply of sludge (with necessary moisture content)

As general benefits and selling points

- ✓ recovery of carbon and nutrients from excess sludge and pruning waste
- ✓ enteric pathogens are destroyed during composting
- ✓ excellent opportunity to recycle green waste within cities
- ✓ opportunity to sell compost → generate income
- ✓ The citizens of Athens shall benefit from greener parks and spaces.
- ✓ Blue/green spaces have a positive effect on human health and wellbeing.



- ✓ These green areas have positive effects on climate change resiliency and help reduce urban island effects, making the Plant Nursery and similar green areas increasingly important in urban planning.
- ✓ Circular solutions that produce valuable resources from waste help promote a shift in people's mindsets regarding the need for a transition to circular economy.

2.1.5 Principle and main characteristics of the technology

Composting, or controlled biological decomposition of organic and green and woody wastes for the purpose of soil enhancement, is a well-known technology widely used in food and agricultural waste processing.

The most common technology is called windrow composting, where the raw materials are organised in open field longitudinal piles and special machines are turning and mixing them to maintain aerobic conditions (Figure 3).



Figure 3 Example for windrow composting (Alamy Stock Photo)

This extensive technology requires a very large footprint and typically three to six months for proper compost ripening, and is rather smelly and subject to changing weather conditions. Compost quality and biological processes can be seriously affected by extremities like floods, droughts or extreme heats. The technology is not well suited in urban environment and for small decentralised operations.

Recent developments in biotechnology have made possible to speed up biological decomposition processes using solid phase bioreactors operating in controlled environment. In-vessel composting has been developed especially for composting food and animal wastes and is becoming more preferred when large volumes of organic wastes need to be processed in a completely closed environment. In-vessel composting technology offers reduction in time



and space but still are typically operated in large centralised waste processing facilities (Figure 4).



Figure 4 Example for in-vessel composting (google images)

The RCB (Rapid Composting Bioreactor) technology is a vertical flow arrangement composting bioreactor, which has been tested in Taiwan by Benne and Greenwich Investment in the past years for medium scale operations in the size of 35 to 100 m³ reactor volumes. The technology represents an in-vessel, controlled environment technology, where the raw materials are continuously fed into a solid phase bioreactor, inoculated with selected microorganisms, and continuously mixed and aerated, while the operating parameters (temperature, humidity, oxygen content) are properly measured and controlled.

The RCB unit implemented at the Athens tree nursery site is a downscaled version of the industrial RCB unit described above (Figure 5).



Figure 5 RCB implemented in Athens (image: Zoltán Csipai)

The unit size is specifically targeting small to medium scale decentralised use, whereby wastewater excess sludge from a local water recycling unit and plant pruning wastes from the nearby urban environment are converted into valuable compost material, which can be used in local green spaces. Figure 6 and Figure 7 show the overall scheme and details for its construction, respectively.



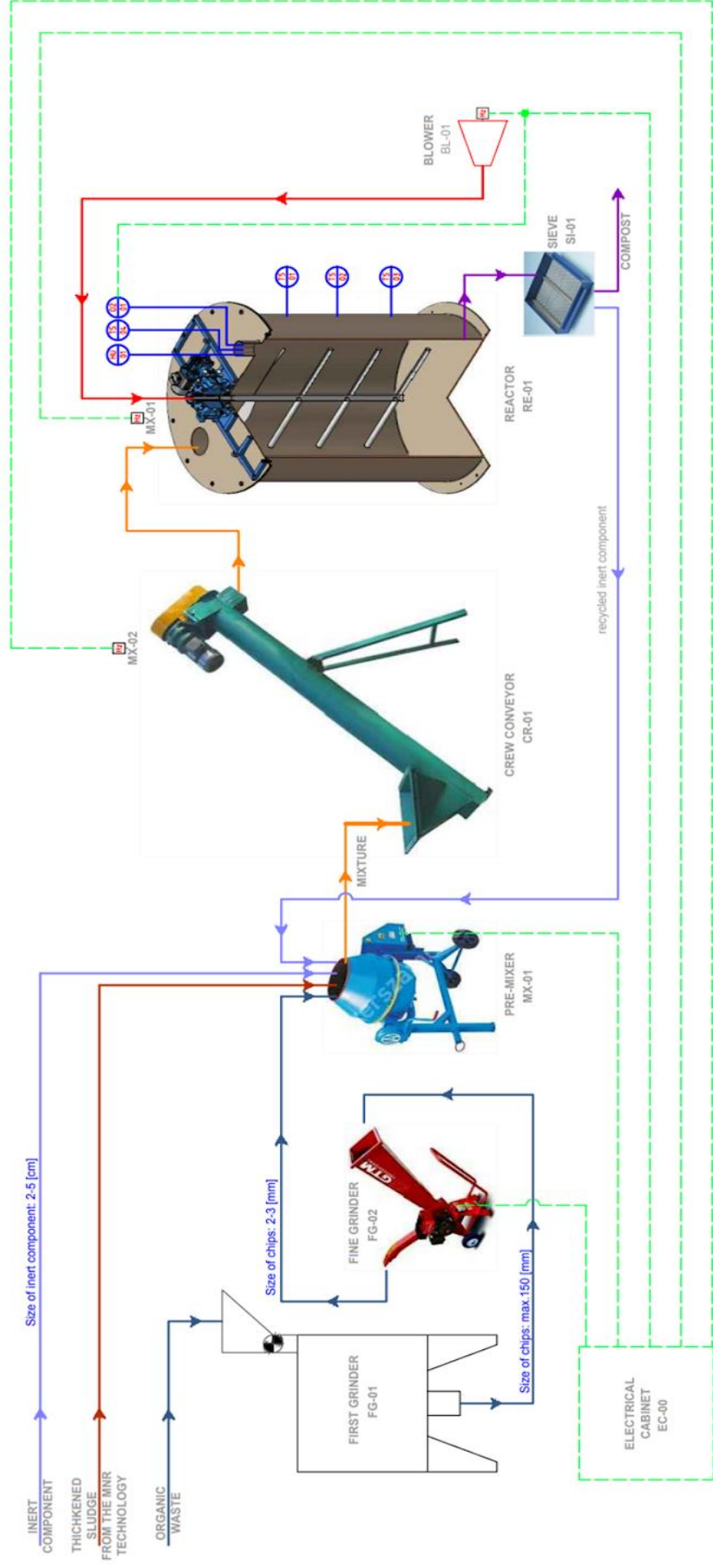

Figure 6 Overall scheme of the RCB in Athens



Figure 7 RCB under construction in Athens at the Tree Nursery

2.1.6 Requirements for the implementation of the technology and operating conditions

Due to this controlled environment, the Rapid Composting Bioreactor is roughly 5 times faster than conventional composting, which produces compost-based eco-engineered media free of enteric pathogens. The air outlet from the reactor is equipped with an air filter to ensure odourless operation.

Prior to the rapid composting, the excess sludge from the wastewater treatment plant needs to be thickened. The wood and green waste is shredded, homogenized and sorted – to get a 2-5 mm fraction by sieving in a pre-treatment step. In a mixing unit, the homogenised wood and green waste is mixed with the thickened excess sludge and an inert filling material consisting of shredded wood of 2-5 cm size. Approximately 700 L/per week are incubated in the rapid composting unit – an in-vessel composting system - at mostly aerobic conditions due to continuous air supply by the connected blower. Here, at a temperature between 50 °C and 70 °C, aerobic microorganisms convert approximately 20% to 30% of the volatile organic material to CO₂ and water (Metcalf et al. 2013) and thus, stabilize the material. A heat pump can be used to preheat the reactor and to accelerate the process further.

The output is a compost-based growing media product with output rate of around 150 -180 kg per week. The output compost goes through a sieve to get back the inert filling material.

The excess sludge has to be thickened prior to the rapid composting. Its dry solids (DS) content should be at least 5% - but based on the process assessment this value may be revised. The ratio between the wood and green waste to the thickened excess sludge should be evaluated before the start-up. The process is operated at a temperature of up to 70°C and the retention time in the composting unit ranges between 10 and 20 days (Table 8).

Table 8 Requirements and operating conditions for the RCB

Parameter	Units	Min	Max	Reference
Dry solids (DS) content of excess sludge	%	5	7	Own data
Ratio of green/wood waste to thickened excess sludge	-	1:1	1:2	Own data
Temperature during high rate conversion of volatile compounds	°C	50	70	Metcalf et al. 2013
Oxygen content in gas output of composting unit	%	5	10	Own data
pH for optimum aerobic decomposition	-	7	7.5	Metcalf et al. 2013
Volatile solids of composting mix	%	30	-	Metcalf et al. 2013
Moisture content of composting mix	%	40	50	Own data
Solid material retention time	d	10	20	Own data



2.1.7 Results

Scaling Down Challenges & Optimisation

Several challenges were encountered when scaling down the rapid composting unit for the Athens pilot site. The mechanical design was dependent not only on the system scale, but also on the composition and size of the input materials. Therefore, the optimisation of the production process was largely trial and error. Additionally, construction and installation of the composting and heat recovery units suffered severe delays due to Covid travel restrictions and international shipping delays.

The following is a brief summary of the optimisation process:

2021 June - September – Installation of the mechanical, electrical, and control equipment for Rapid Composting Bioreactor Unit. The onsite Pezzolati coarse shredder (at the nursery) was supplemented with a fine shredder (purchased for the project) in order to achieve a better size distribution of the pruning waste. The sludge thickening process was initiated and in 1 week approximately 5-7% dry matter sludge was achieved.

2021. October 5 – Failure of the mixing wing of the rapid composting bioreactor during equipment commissioning. The mixing arm was not able to handle the inserted material and deformed during mixing (Figure 8). The green waste used was more woody and dry than originally anticipated during design, therefore the overall moisture content of the mixture was low, placing too much pressure on the mixing arm, causing deformation.

Measurements of dry matter content show that the woody waste is very dry, therefore the ratio of wood waste to sludge was reduced from 2:1 to 1:1. The 1:1 mixture of pruning waste (20% DS) and thickened sludge (6% DS) should provide a moisture content of 54%.

The onsite nursery coarse shredder became unavailable for use, and therefore the fine shredder previously purchased was no longer adequate to shred the woody waste to the desired size. A new heavy duty fine shredder was tested and installed in January 2022.

2021. October, November – Design adjustments for the repair of the new mixing arm, were made, in order to restart the system as soon as possible. Simultaneously, the design of a new more robust mixing arm was initiated for a more robust long-term solution (Figure 8). Mechanical inspection of broken mixing arm showed it cannot be repaired. Installation of pumps, heat exchanger spiral, thermal insulation, and electrical connection were installed in preparation for the heat recovery unit.

2022. February– Installation and testing of new mixing arm.

2022. March – Restarting the composting unit found that as the dry woody material was added to the reactor tank, the electric motor (200 W) responsible for mixing was not strong enough to handle the weight of the new mixing arm and the dry material. A new stronger motor and inverter were installed. The new motor worked well, and was able to handle the mixing arm and the material.

2022. April, May – The composting unit was restarted and the composting unit was filled 60-70% with pruning waste, with everything working well. Thickened sludge was slowly added to the tank, replacing the pruning waste. The mixing arm and the motor held up well.



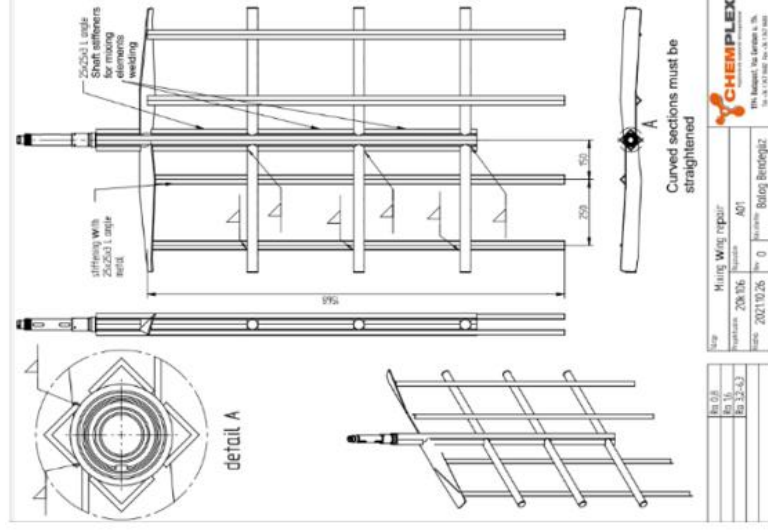

Figure 8 Left: Deformed mixing arm; middle: adjusted design of the mixing organ; right: new mixing organ

The energy recovery unit (and its associated electrical equipment) was successfully installed and commissioned. During operation of the composting unit, it was observed that the mixing process was not ideal, therefore the mixing arm design was optimised to improve mixing within the tank (Figure 9). The system was restarted.

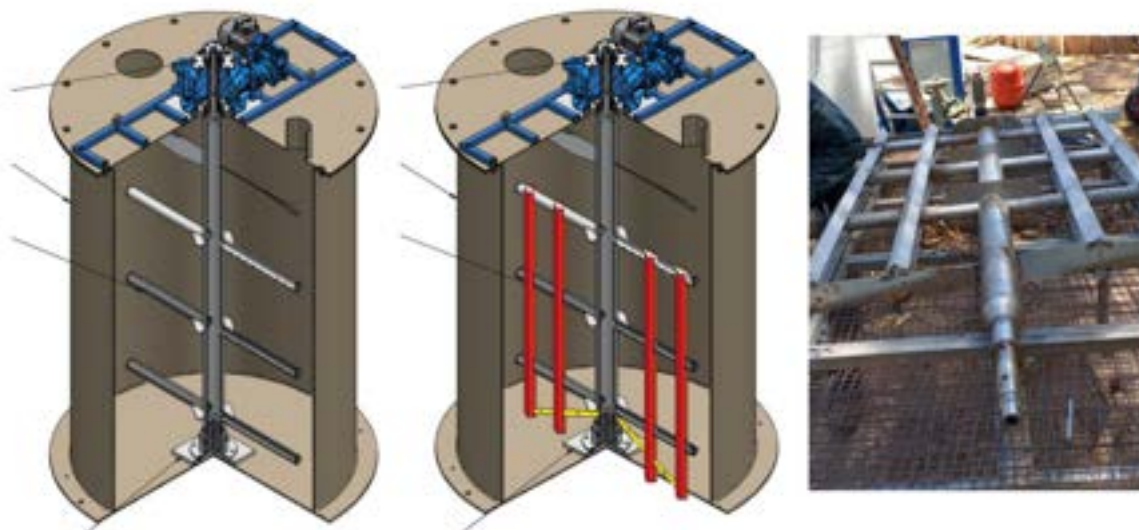

Figure 9 Scheme of the RCB showing the mixing device before (on the left) and after optimisation (in the middle) and finally, the new optimised mixing device (on the right)

2022. June, July – The motor and the mixing arm was functioning fine and material was added and commissioning was continued. Operations were once again stopped when the upper part of the mixing arm (where it is less robust because it is where the arm inserts into the reducer of the motor) broke during operation. Further improvements were made to the mixing arm including: welding the upper part of the arm, and securing the base with four additional holes and industrial dowels (Figure 10).



Figure 10 Mixing arm with further improvements

After improvements, the extra weight from the reinforcements and the repairs caused problems with the motor not being able to handle the additional weight. A mechanical engineer reviewed the situation and found that due to the original design of the composting unit, replacing the existing motor with an even larger one would have resulted in replacing the motor, gearbox, and the mixing arm.

Therefore, after considering all the alternatives, the following adjustments were made to address the problem: the existing elements of the arm were readjusted with new metal horizontal elements with digging corners as well as new holes that were constructed to support the blowing process (Figure 11). The construction was more robust and lighter, so that it can work with the existing motor.



Figure 11 *Readjustment of the existing elements of the mixing arm*

In addition to mechanical changes, the unit was adjusted for automation. When the motor encounters strong resistance in the mixing arm, the PLC changes the direction of rotation. This should prevent future failure of the arm.

2022. August - September – After 1.5 months of working normally, just before adding the inoculum material and starting compost production, the unit stopped working suddenly. The problem occurred after heavy rains. The composting unit was not fully waterproof and the heavy rains seeped into the drum and hardened the material blocking rotation. The new mixing arm construction remained intact, however; damage occurred at the weakest point (previously repaired).

The upper thinner part of the mixing arm was reinforced by double welding it in two positions to ensure strength. Small vertical elements were also added to improve mixing. The composting material was added to the unit and the composting process was allowed to continue.



Figure 12 *Reinforcement of mixing arm by double welding in two positions*

Feed Material Optimisation

Both the scale-down and the characteristics of the available waste streams at this specific plant nursery site required additional optimisation steps. The dry woody character of the pruning waste required special care in the shredding step, compared to a typically green and high moisture content leafy green waste.

First, we had to find the best technology and equipment to shred this material into 2 to 5 mm fractions. Figure 13 (1-2) shows the small fine cutting device and a more robust shredder using a hammer mill principle, this latter proved to be more suitable for the above task. Figure 13 (5) illustrates the fractionation of the shredded wood waste using sieves and screens with different opening sizes.

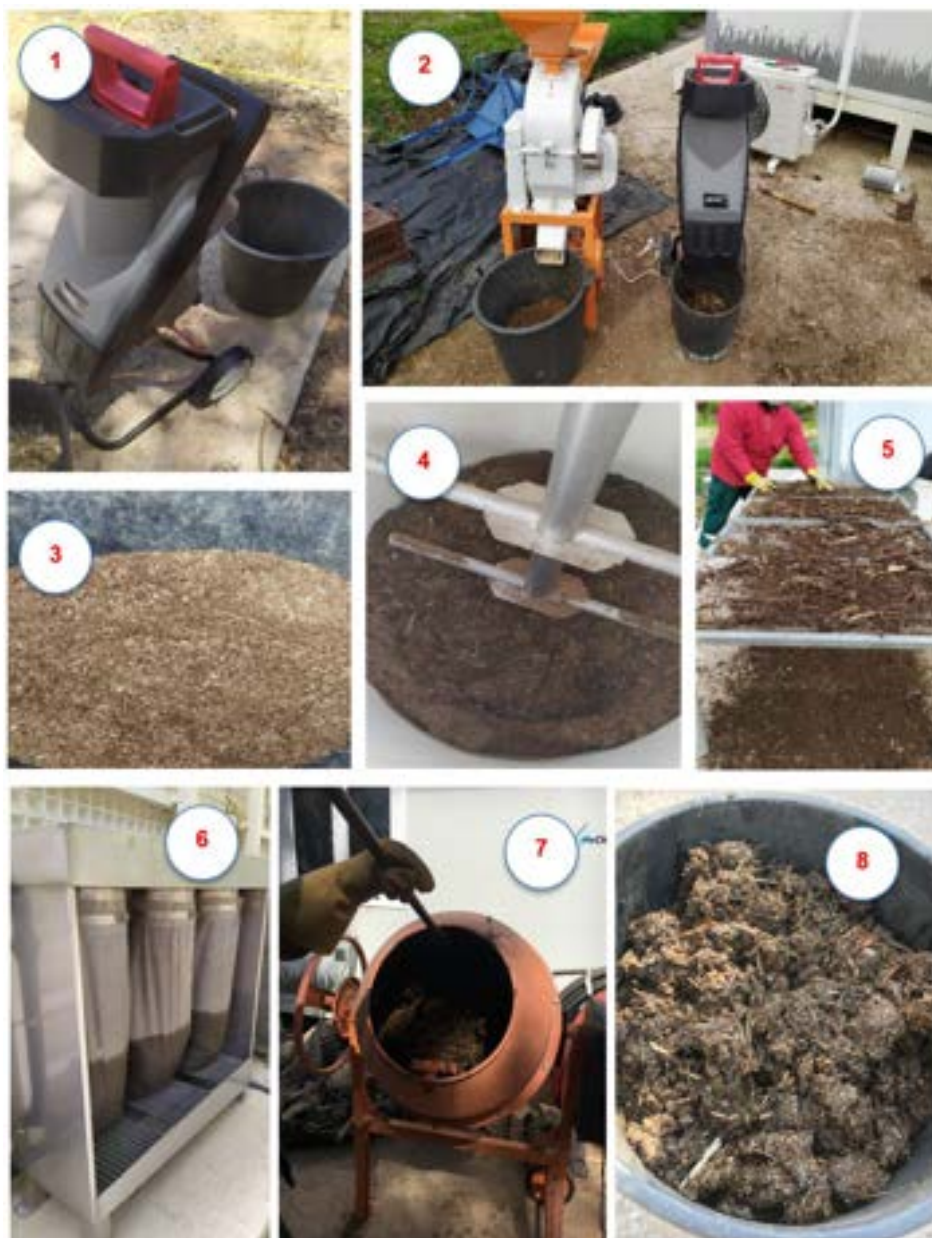

Figure 13-1-small capacity fine shredder; 2-testing different shredder for wood waste; 3-shredded and screened wood waste mixture; 4-mixing test with compost raw material; 5-wood waste fractionation; 6-sludge thickening with filter bags; 7-testing different premixes of shredded wood waste and thickened sludge; 8-raw feed material to rapid composting

Secondly, as excess sludge dewatering was not installed in the wastewater treatment unit, a pre-thickening step was proposed to reach the required 5% solid content of the sludge stream. Figure 13 (6) shows this thickening step using commercially available filter bag equipment.

Finally, various tests have been conducted to find the proper ratio and mixture of the two waste streams. Different sludge to pruning waste ratios have been tested and moisture, organic and nutrient contents and rheological properties have been measured. Figure 13 (3, 4, 7 and 8) gives some illustrations to these tests.

2.1.8 Comparison of the baseline situation and the NextGen KPIs

Based on the experience gained from the pilot system, we have recalculated the operating conditions and consequently the CAPEX and OPEX values of a full scale plant. The tables (Table 9 and Table 10) are based on a system with a sewer mining/waste water treatment capacity of 250 m³/d, with an operational time of 250 days per year for the vegetative period from March to early November.

When using a Rapid Composting Bioreactor, practically all the nitrogen and phosphorus content of the sludge and pruning wastes can be fully converted into a high organic content material with slow nutrient release characteristics. From the plants' nutrient utilisation perspective, all the 2.7 t/a nitrogen and the 0.9 t/a phosphorus can be taken into account as fully recoverable. A value chain assessment for the Athens case was presented in D5.2.

Table 9 Key performance indicators of the RCB



Parameter	Unit	Pruning waste	Thickened excess sludge	Compost
		Baseline + NextGen	NextGen	NextGen
Mass	[t/a]	105	140	60.4
Dry matter (DM)	[%]	40	5	60
Volatile solids	[% of DM]	60	80	50
Total N	[% of DM]	2	5	2.7
Total P	[% of DM]	0.2	3.7	0.9

Table 10 CAPEX and OPEX of the RCB in Athens

	CAPEX	OPEX	Remarks
RCB full scale, with 20 m ³ total bioreactor volume, complete with raw material preparation, feeding and product handling equipment	200'000 EUR	15'300 EUR/a	OPEX is calculated for 250 days per year operation. OPEX includes total energy requirements, plus labour and inoculum costs



2.1.9 Lessons learned from technology operation

Required competence	
<p>A trained laborer is sufficient for day to day activities and should be trained for one month (through two compost cycles)</p>	
Maintenance	
<ul style="list-style-type: none"> ▪ One scheduled maintenance day per year is expected, during winter shutdown. ▪ The duration of a normal maintenance procedure is one day for regular maintenance and more if parts replacement is necessary. ▪ Until the system is fully automated, manual process control is necessary. Part-time oversight by a technical employee (1-2 hrs per day) is required for the unit, in case of unforeseen events. ▪ To conduct the maintenance procedure, an (external) engineering expert is needed to evaluate system for aging and component changes. 	
Technological risks	
<p>Reasons for downtimes or technical risks: mechanical error, electrical malfunction/ power outage</p> <p>Frequency of plant downtimes per year: non-stop operation 9 months per year, unless malfunction occurs</p> <p>Duration of plant downtimes: annual shut-down, 3 months per year- during winter months; in case of malfunction, system can be restarted once the mechanical or electrical error has been repaired</p> <p>In the event of mechanical or electrical malfunction, (external) engineering experts may be needed. For power outages, no expert is needed to restart the system.</p> <p>Measures that can avoid such downtimes: regular maintenance, and the addition of a generator or alternative power source as a backup for power outages</p>	

2.1.10 Best practice guideline to design and operate the technology

For the construction of the plant, it is important to make sure that robust equipment is installed to ensure adequate cutting/shredding and mixing of green/woody waste and sludge. The motor must be adequately sized to be able to handle the weight of the equipment and the material within the composting unit.



For the start-up of the plant, it is crucial, to establish the proper green/ woody waste and sludge ratio. This ratio may be fine-tuned during system commissioning. In addition, proper inoculation is needed during start-up to establish the desired environment within the composting unit.

The main parameters crucial for optimisation of the compost production process are temperature and oxygen availability (in order to maintain aerobic conditions). The humidity should be 40%, and the compost temperature should be between 50 -70 °C.



2.2 Granular activated carbon production in Altenrhein (CH)

Authors: Anders Nättorp (FHNW), Luca Loreggian (FHNW), Martin Schaub (CTU)

2.2.1 Description of the demo site

The WWTP of Altenrhein provides residential drainage-, wastewater- and sludge treatment of 17 municipalities in two federal states (St. Gallen and Appenzell-Ausserrhoden).

The treated water reaches Lake Constance via the mouth of the Old Rhine. Both Lake Constance and the Old Rhine are considered priority water bodies for protection. Lake Constance also serves as a drinking water reservoir. The topographical conditions around these 17 municipalities vary greatly which makes the water transportation more challenging. For this reason, special structures are required.

Sludge that is being treated in Altenrhein originates from their own water treatment and is also being transported to the site by other WWTP of Eastern Switzerland. The WWTP of Altenrhein (AVA) has advanced energy-efficient sludge management technologies for 300.000 PE of sludge: sludge is dried on site and is co-incinerated in cement works. The heat for sludge drying is generated by burning of sewage gas and by heat recovery from wastewater using heat pumps.

AVA took a full-scale removal of micropollutants by ozonation and active carbon adsorption into operation in 2019 and an ammonia membrane stripping unit from sludge dewatering employing an innovative membrane contactor with a novel low fouling membrane module in 2021. This represents a total investment of EUR 20 Mio in innovative technologies.

2.2.2 Motivation of implementing circular economy solutions in the water sector

After the project AVA will have a clear idea of the technical and financial feasibility of on-site activated carbon regeneration and production of fresh activated carbon using locally available sludge and biomass. Long-term experience with full-scale installations for micropollutant removal and N recovery gained with the installations at Altenrhein will reduce investment risks, enhance chances of replicability.

AVA also gathers all the necessary information to take an investment decision regarding the construction of a PK-fertiliser production unit. This novel thermochemical process transforms sewage sludge into a market grade PK-fertiliser. Thereby heavy metals are partly removed and the fully plant available mineral phase CaKPO_4 is produced. The process has been piloted in a large-scale pilot to gain further operational experience.



2.2.3 Actions and case study objectives

Table 11 Action and objective regarding GAC production in Altenrhein

Case Study & Subtask	Technology baseline	NextGen intervention in circular economy for water sector	TRL	Capacity	Quantifiable target
#4 Altenrhein Switzerland Sub-task 1.4.3	Filtration with commercial GAC after ozonation	Production of renewable GAC via pyrolysis, activation	TRL 5 → 6	Production: 1 kg/h Filtration: 0.2 m ³ /h	Renewable GAC used for micro-pollutants removal

2.2.4 Unique selling points

Unique selling points to produce granular activated carbon from renewable raw material are:

- ✓ High quality product: renewable GAC
- ✓ Can be used for adsorption of contaminants from wastewater or polluted air
- ✓ Pathogen free
- ✓ Expected lower environmental footprint than traditional GAC from stone coal

2.2.5 Principal and main characteristics of the technology

Activated carbon is the collective name for carbonaceous adsorbents. Activated carbon is a non-hazardous, processed carbonaceous material with a porous structure and a large internal surface area (Henning and von Kienle 2010). GAC are produced from any carbon source (fossil, waste or renewable) and engineered to be used as sorbent to remove contaminants (Hagemann et al. 2018). GAC are capable of purifying wastewater via adsorption from contaminants such as phenols, acid dyes, pesticides and heavy metals. Their efficiency depends on the active surface, the porous structure, and surface functional groups of the activate carbon.

Production of GAC from a renewable biomass requires pyrolysis and activation. First, the carbonaceous precursor is pyrolysed at temperatures between 200 and 950 °C (Metcalf et al. 2013, Smets et al. 2016). The volatile matter from the biomass is removed and the biosolids are converted into a char characterised by a relatively high carbon content and a preliminary porosity. After pyrolysis, the carbon undergoes activation. Physical activation of the carbonised material consists of a partial and controlled gasification at high temperatures (i.e., 800 °C and 950 °C) with steam, CO₂, air or a mixture of those (Plaza et al. 2014, Gergova et al. 1996, Rodriguez-Reinoso et al. 1995, Smets et al. 2016). During physical activation, the oxidising gas removes the disorganized material, and eliminates the more reactive carbon



atoms of the structure generating the porosity and contributing to the burn-off (Rodriguez-Reinoso et al. 1995).

Most pyrolysis systems require dried biomass in a granular form with a certain degree of uniformity in the material and low dust content (Metcalf et al. 2013). While traditionally GAC are produced from black coal, production of GACs from renewable sources (from here on “renewable GAC”) such as sewage sludge and fruit stones has been explored in the recent years (Hagemann et al. 2018, Benstoem et al. 2017, Hadi et al. 2015).

After use, GAC can be reactivated. For sustainability reasons, use of reactivated GAC is preferred over virgin GAC. Conventional GAC can be regenerated with quality comparable to virgin material with a weight loss of 10%. The process could potentially be implemented at wastewater treatment plants with a capacity of 100'000 population equivalents and greater. Considering the lower adsorption capacity of renewable GAC compared to GAC from stone coal, the material has to be regenerated three times more often and the demand for fresh material replenishment for this size of plant is about 50 t/year for conventional and 120 t/year for renewable GAC from sewage sludge. In general reactivation uses wet spent GAC. Drying, desorption, thermal cracking, and gasification can be performed in a single industrial reactor (Metcalf et al. 2013).

Within Nextgen, the production of GAC for micropollutants elimination was investigated using drying and granulated sewage sludge (SS) from WWTP Altenrhein, and cherry pits (CP) from the region of Basel.

Prior to pyrolysis and activation, SS was dried and granulated, while CP were milled, and sieved to remove the finest fraction. In fact, fines are not suitable for GAC production, they contribute to an increased energy consumption, higher temperature in the burning chamber, and increased consumption of activating agent, while are quickly lost in the effluent during the first period of operation.

Thermal conversion of these biomasses was performed in one step on a PYREKA research pyrolysis and activation unit (Pyreg GmbH, Dörth, Germany) at Agroscope (Reckenholz, Switzerland) (Figure 14 - Figure 17). The reactor consists of a 1 m long tube where an auger transports the feedstock. Depending on the activating agent, and the desired conditions to be tested, the reactor was electrically heated between 700 and 900 °C, with variable residence time of 10-30 min. The activating agents (gas, or steam) are dosed via an electronic valve directly into the reactor. The flux of the activating agents are regulated based on the feeding rate of the feedstock inside the reactor, its carbon content, and stoichiometric calculation as in (Hagemann et al., 2020). At the end of the reactor, the product was collected into a water-cooled and air-tight container. The discharge tube as well as the feeder are flushed continuously with Argon gas, to avoid atmospheric air incoming to the reactor. The discharge tube was also heated to 400°C to reduce re-condensation of volatiles on the solids. The syngas was combusted in a separate burning chamber. The solids yield was monitored.



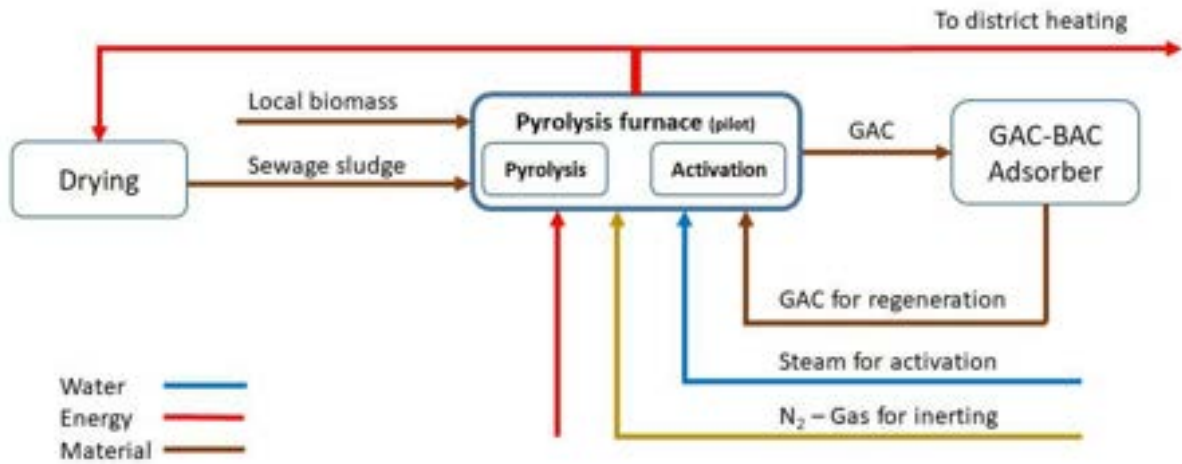

Figure 14 Flow scheme of the pyrolysis and activation processes integrated in the sewage sludge management of WWTP Altenrhein

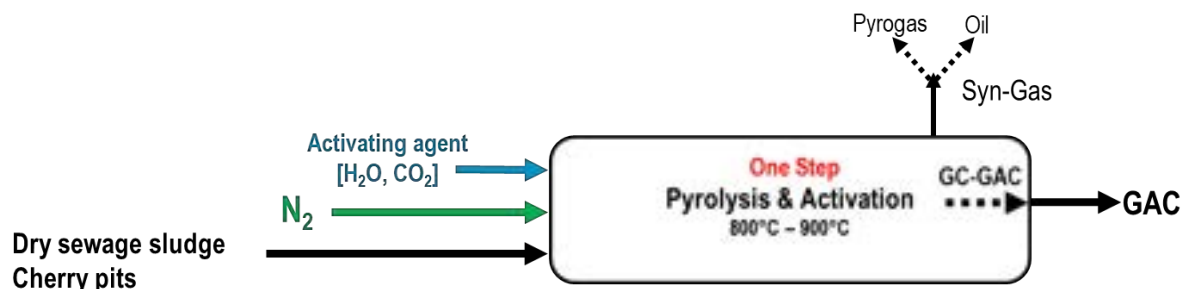

Figure 15 Flow scheme of the PYREKA research pyrolysis and activation unit (Pyreg GmbH, Dörth, Germany) at Agroscope (Reckenholz, Switzerland)

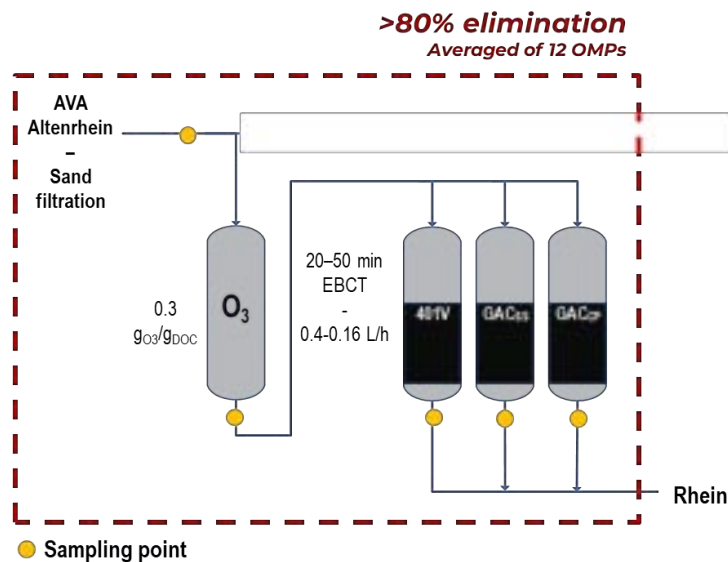

Figure 16 Flow scheme of the ozonation and GACs pilot plant at WWTP Altenrhein as tertiary treatment for municipal wastewater



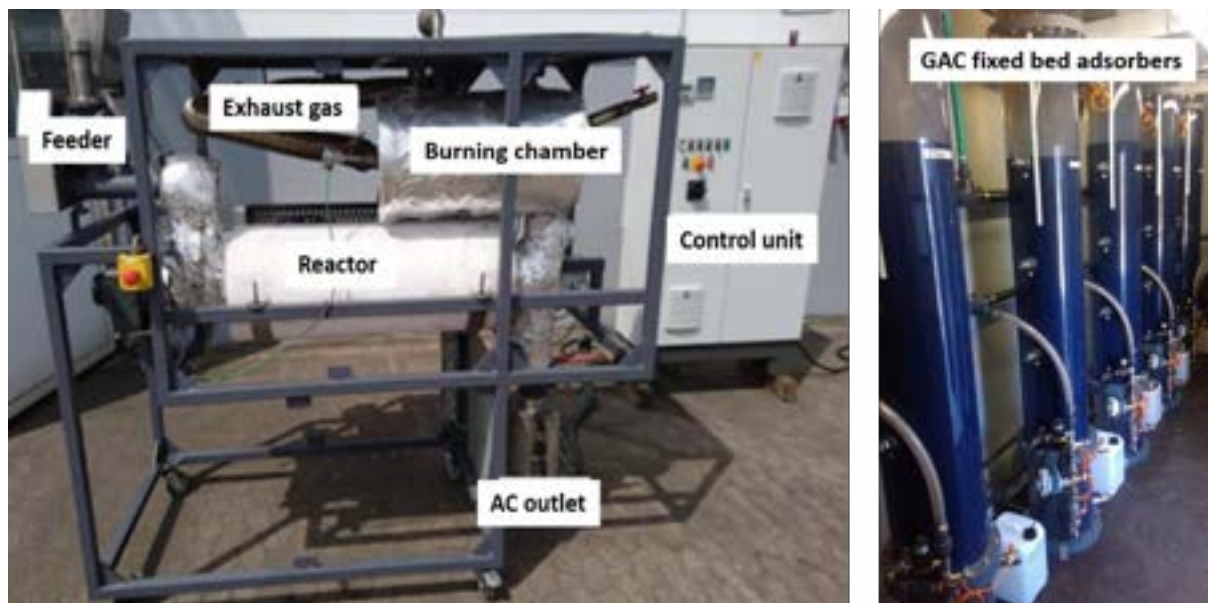

Figure 17 Pictures of the PYREKA research pyrolysis and activation unit (Pyreg GmbH, Dörth, Germany) at Agroscope (Reckenholz, Switzerland) on the left panel, and the pilot scale GAC contactors at WWTP Altenrhein on the right panel.

2.2.6 Requirements for the implementation of the technology and operating conditions

The conditions for manufacturing efficient adsorbent for OMPs elimination in wastewater depend on the type of feedstock used.

Main parameters influencing carbon quality are activation agent, temperature, and residence time. Based on literature, a few conditions were selected for investigation with (1) sewage sludge from WWTP Altenrhein, and (2) cherry pits from the region of Basel (Switzerland), as feedstocks (Table 12). The best conditions for pyrolysis and activation are defined after physical characterization of GAC, as well as evaluation of their adsorption capacity.

Pilot trials are required to identify the best conditions for pyrolysis and activation. A total of 21 activated carbons were produced, and two GACs reference materials were used (i.e., Cyclecarb 401V from Chemviron, and Norit AG 830 from Carbotech).

Table 12 Operating conditions, feedstock and activating agent for GAC production

Parameter	Operating conditions, etc.
Feedstocks	Cherry pits, municipal sewage sludge
Activating agent	Steam, CO ₂
Reaction temperature	700 – 900 °C
Residence time	10 – 30 min

Pilot trials with wastewater were performed in Altenrhein to define the best conditions for operation (empty bed contact time (EBCT), and the O₃ dose in the upstream process). A longer EBCT may compensate for lack of adsorption. If GAC and ozonation are used in combination,



the ozone doses shall also be adjusted to meet legal requirements. Operators shall be aware of potential increase of ecotoxicity (Kienle et al., 2022). In this regard, the effect of post treatment with renewable GAC remains to be investigated.

2.2.7 Results

Properties of granular activated carbon

Conditions of pyrolysis and activation (i.e., temperature, activating agent, residence time, and type of feedstock) affect yield of production, physical properties (i.e., ash content, surface, density, hardness), and adsorption capacity of GAC.

The type of feedstocks, and the choice of activating agent, are the major factors influencing the ash content and the burn off (Figure 18). Losses during pyrolysis and activation are smaller in SS (i.e., 40%-60%) than CP (i.e., 75%-80%) (Figure 19, right panel). Steam is a more powerful agent than CO₂, it results in 5% higher burn off in CP and 10% higher in SS. Residence time in the reactor does not affect material burn off. As expected, the ash content in GAC from SS (GAC_{SS}) is higher than in GAC from CP (GAC_{CP}), respectively 90% and 85% in GAC_{SS} depending on the activating agent, and 5-7% in GAC_{CP}. With regards to the GAC_{SS}, the higher the burn off is, the higher the ash content will be. The ash content in the references (GAC_{Ref}) (Cyclecarb 401V and Norit 830) ranges between 8 and 12%.

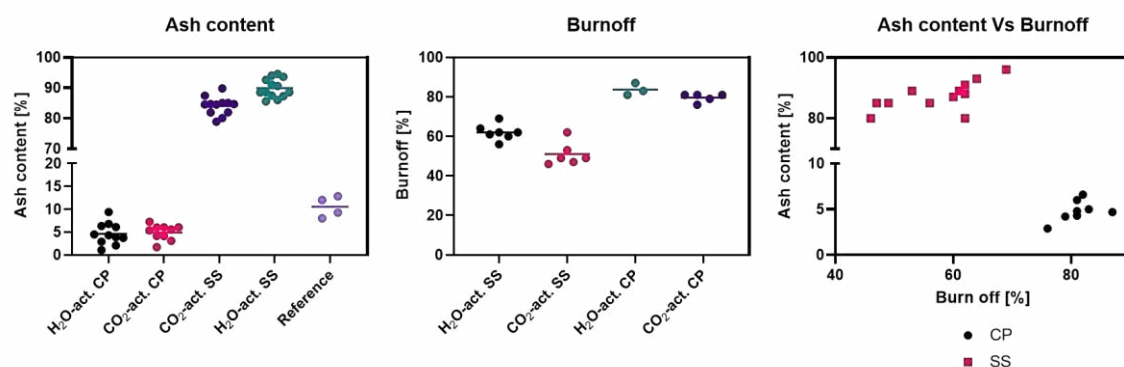

Figure 18 Ash content in GAC_{SS} activated with steam, and CO₂, in GAC_{CP} activated with steam, and CO₂, as well as in GAC_{Ref} (left panel). Burn off GAC during pyrolysis and activation with CO₂ and steam of sewage, cherry pits (central panel), as well as all the investigated conditions sludge (middle panel). Correlation between ash content and burn off in GAC_{SS}, and GAC_{CP}.

In general, GACs from renewable biomass are less hard than GAC_{Ref} (94 and 98%), produced from coal commercially obtained (i.e., > 90%). GAC_{CP} appears to be a harder material than GAC_{SS}. High temperatures lead to more brittle material when using sewage sludge, and significantly more, when steam is used instead of CO₂. When using GAC_{SS}, higher percentage of activating agent (i.e., steam) decreases hardness (Figure 19, right panel). As in the case of density, burn off, and ash content, the residence time in the reactor does not affect the hardness of GAC.

Active surfaces, by the Brunauer-Emmet-Teller method (BET), increase at high temperature (Figure 20, left panel). 700°C and CO₂ as activating agent appear to be insufficient to achieve high BET surface (i.e., similar to GAC_{Ref}).



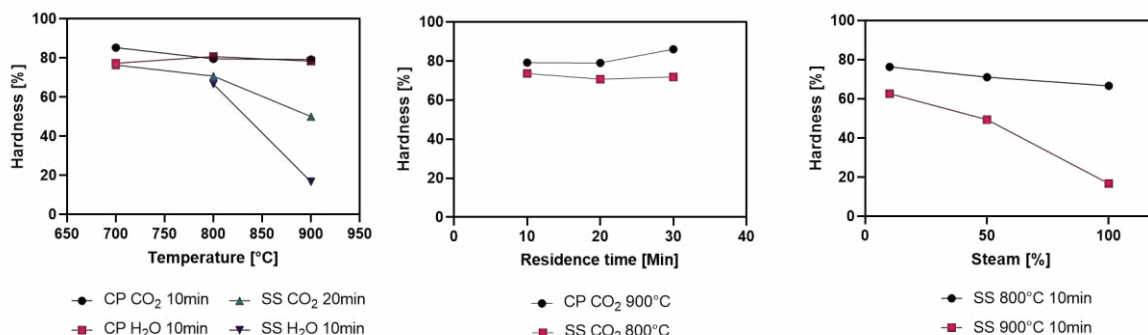

Figure 19 Hardness in GAC_{SS} activated with steam, and CO₂, in GAC_{CP} activated with steam, and CO₂, at different temperature (left panel), residence time (central panel), and percentage of activating agent (right panel).

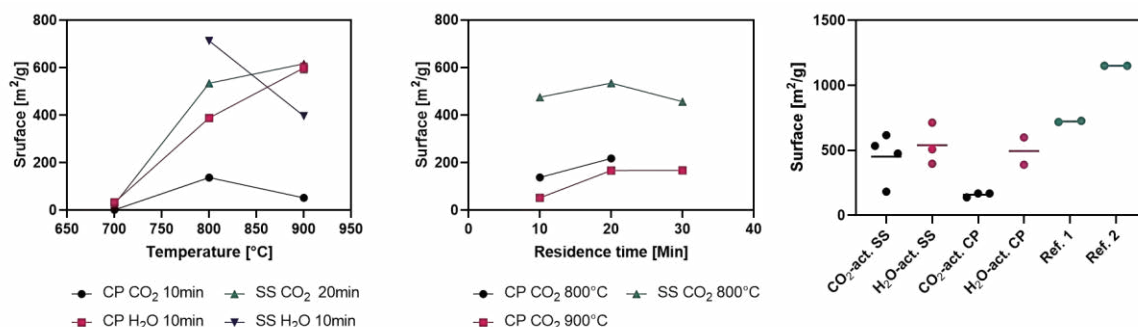

Figure 20 Active surface (Brunauer -Emmet-Teller, BET) in GAC_{SS} activated with steam, and CO₂, in GAC_{CP} activated with steam, and CO₂ at different temperature (left panel), and residence time (right panel), summary of surface measurements of the 21 GACs samples

CO₂ is expected to be only a mild oxidant below 800°C, and the reaction velocity is so reduced that the activation process ceases for practical purposes (Henning and von Kienle, 2010). However, reaction with steam is 8 times faster than CO₂. Lower temperature can be used than in the case of steam (Cha et al., 2016). In fact, the highest BET within the dataset is obtained when CP is pyrolysed CP at 800 °C with steam. On average, activation with steam appears to yield higher BET surface than CO₂ both in the case of SS and CP (Figure 20, right panel).

Organic micropollutants elimination

The performance of all GAC was evaluated via batch experiment isotherms using absorbance at UV₂₅₄, or elimination of methyl orange. Additionally, selected GAC samples were tested in similar batch configuration experiments for direct elimination of organic micropollutants (i.e., lead -substances listed in the Swiss Water Protection Ordinance; Table 13, Figure 21).

Table 13 Freundlich adsorption capacity parameter (K_F) ($\mu\text{g}/\text{mg}$) (L/mg)^{1/n}, Freundlich adsorption intensity parameter (1/N)(unitless), and R-squared (R^2) for Amisulpride, Citalopram, Metoprolol, Benzotriazole, Irbesartan, and Candesartan adsorption onto Cyclecarb 401V, GAC_{SS}, and GAC_{CP}.

	Amisulpride			Citalopram			Metoprolol			Benzotriazole			Irbesartan			Candesartan		
	K_F	1/N	R^2	K_F	1/n	R^2	K_F	1/n	R^2	K_F	1/n	R^2	K_F	1/n	R^2	K_F	1/n	R^2
C401V	0.27	2.98	0.77	0.30	1.88	0.83	0.10	2.31	0.65	1.01	3.17	0.45	0.24	2.28	0.62	0.06	4.04	-0.07
GAC _{CP}	0.05	0.21	0.69	0.02	0.23	0.74	0.02	0.17	0.42	1.21	0.29	0.43	0.08	6.57	0.88	NaN	NaN	NaN
GAC _{SS}	0.06	1.21	0.82	0.01	0.20	0.10	0.02	1.47	0.11	0.02	0.61	0.07	0.01	1.42	0.68	0.01	4.96	0.37



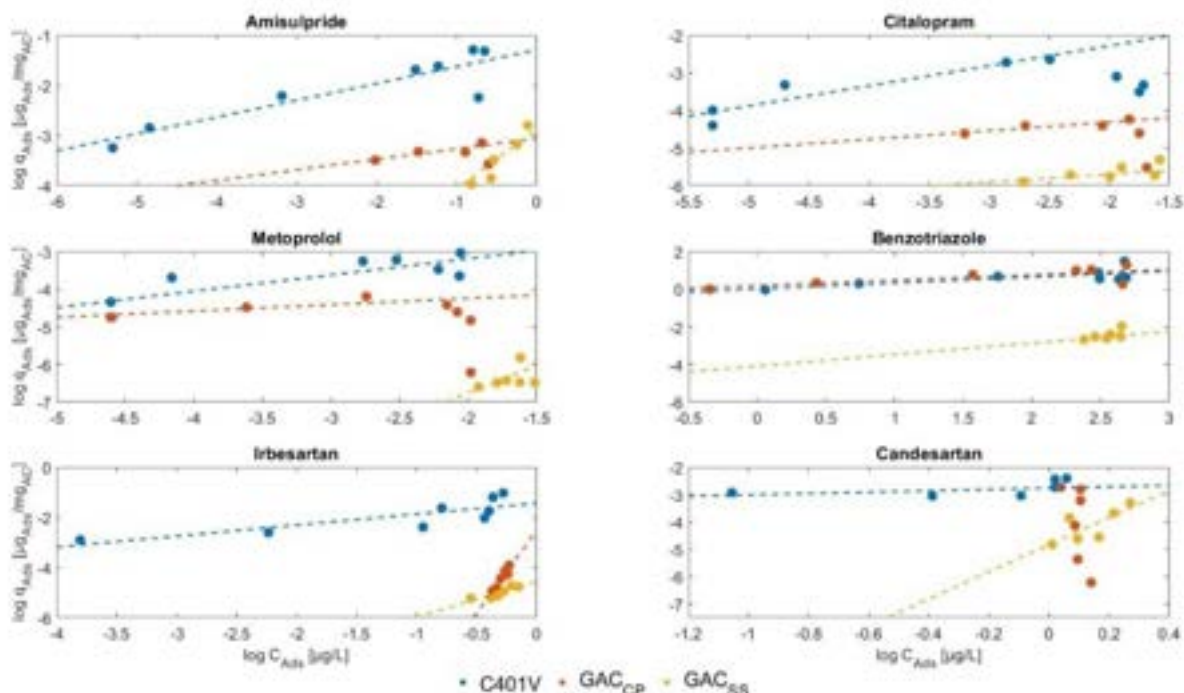

Figure 21 Comparison of single-solute adsorption isotherm for Amisulpride, Citalopram, Metoprolol, Benzotriazole, Irbesartan, and Candesartan for Cyclecarb 401V (blue), GAC_{SS} (red), and GAC_{CP} (yellow). Dashed lines represent Freundlich isotherm on Cyclecarb 401V (blue), GAC_{SS} (red), and GAC_{CP} (yellow).

Test of performances in pilot experiments

Filters with GAC_{Ref}, GAC_{SS}, GAC_{CP} were operated at standard conditions of 20 minutes EBCT until approximately 10'000 bed volumina (BV), corresponding to a specific throughput of 25 m³/kg GAC for GAC_{Ref} and GAC_{SS}, and 50 m³/kg GAC for GAC_{CP} (Table 14, Table 15). After 5 months of operation the EBCT was increased to 50 minutes. After circa 9 months of operation the O₃ dose was increased from 0.3 to 0.5 g O₃/ g DOC for the remaining 7 months of operation.

Table 14 Geometry of the columns

Height (m)	3.6
Diameter (m)	0.32
Area (m ²)	0.08

Table 15 Operational phases, conditions and duration of phases in bed volumina. The number of treated volumina were calculated using the time dependent bed volumina

	Phase	1	2	3
	EBCT (min)	20	50	50
	Ozone (g/g DOC)	0.3	0.3	0.5
	Duration (days)	146	113	216
GAC _{Ref}	Bed volumina (BV)	10303	13865	19160
	Volume treated (m ³)	1401	1835	2462



GAC_{SS}	Bed volumina (BV)	9994	13304	18885
	Volume treated (m ³)	1401	1835	2566
GAC_{CP}	Bed volumina (BV)	11314	14660	19230
	Volume treated (m ³)	1401	1727	2136

Losses of granular activated carbon.

Losses of GAC during operation are due to stress conditions. Fine particles are generated and lost during backwashing particles and/or continuously in the effluent. The formation of fines increases head loss across the filter, this leads to a more severe, and need for more frequent backwashing (Crittenden et al., 2012).

GAC filters height over time was monitored and expressed as fraction of GAC loss from the beginning of the experiment (Table 16, Table 17, Figure 22).

Table 16 Amount of GACs at start and after operational losses

	Initial height [m]	Initial volume [m ³]	Initial mass [kg]	Final height [m]
GAC_{Ref}	1.8	0.145	58	1.47
GAC_{SS}	1.8	0.145	76	1.62
GAC_{CP}	1.8	0.145	38	1.12

Table 17 Concentrations of different parameters in GAC, mass losses and concentrations in effluent

	Concentration in GAC [g/kg]	10% GAC loss [g]	100% GAC loss [g]	Effl. Concentration after 10% mass loss [mg/L]	Effl. Concentration after 100% mass loss [mg/L]	WPO limit [mg/L]	10% mass loss fraction of the limit [%]	100% mass loss fraction of the limit [%]
P	52.76	374.6	3745.9	0.03	0.29	0.30	10	97
Zn	1.41	10.0	100.4	0.001	0.008	0.02	4	39
Cu	0.73	5.2	51.6	0.0004	0.0040	0.0050	8	80
Cr	0.14	1.00	10.03	0.0001	0.0008	0.0050	2	16
Ni	0.06	0.43	4.25	0.00003	0.00033	0.0100	0	3
Cd	0.00	0.01	0.10	0.00000	0.00001	0.00002	4	37
Pb	0.11	0.75	7.51	0.0001	0.0006	0.0100	1	6

During an initial phase until 15000 BV, losses of GAC occurred continuously and to various extents depending on the GACs. Up to 36% of GAC_{CP} was lost, ~10% of GAC_{SS}, and 18% of C401V. Indeed, greater losses are expected with the lightest material (GAC_{CP}, Table 16, Table 17), and the smaller losses with the heaviest one (GAC_{SS}, Table 16, Table 17) (Crittenden et al. 2012). After 15 000 BV, GAC losses were small after improving the conditions of backwashing and its frequencies. However, previous experience from the same plant is that bed material is



lost until the height stabilises at 1.5 m. Thus, the observed losses may be due to the design of the columns. In the full-scale contactors, the material loss is negligible.

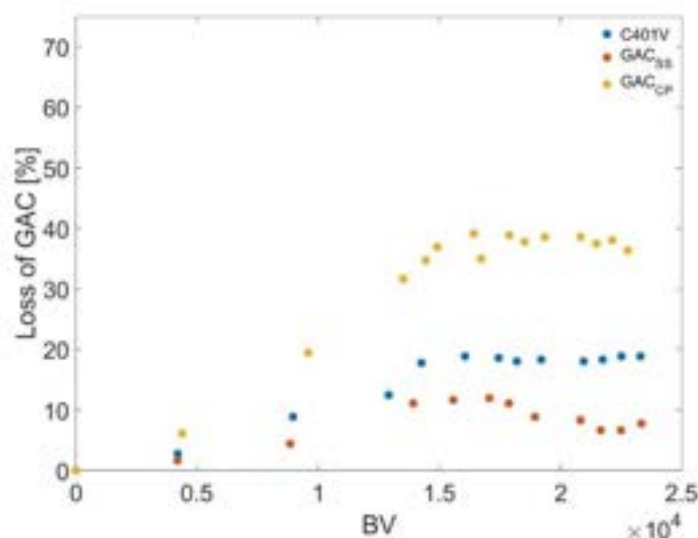

Figure 22 Losses of GAC from the commercial GAC (C401V), and the two renewables GACs over the entire operation of the pilot experiment

After 10 months, the losses in the effluent were monitored for three weeks by a thermogravimetric method (Krahnstöver et al. 2016) in 48 h composite samples. The concentration of the activated carbon remained below the detection limit of the method (0.06 mg/L). According to these measurements, the maximum loss of GAC in the effluent is smaller than 2% of the total total GAC_{SS}. Most of the GAC_{SS} is apparently lost during backwashing. However, hardness measurements indicate that brittle material is lost (see section *Regeneration of spent GAC*), so this measurement should be repeated for fresh columns to determine if this brittle material is lost in the effluent.

Elements generally occurring in sewage sludge and regulated in the Swiss Water Protection Ordinance (“CC 814.201 Waters Protection Ordinance of 28 October 1998 (WPO),” 2020) were monitored over time in the solids. Figure 21 illustrates the concentration of elements of interest over time in GAC_{SS}. Sulfur concentration decreases from 25 mg/kg to 15 mg/kg, probably due to dissolution. On the hand, the concentration of the other elements remains stable throughout the entire duration of the experiment. Hence, loss of elements regulated by law (i.e. Zn, Cu, Cr, Ni, Cd, Pb, and P) are due to loss of GAC’s particles in the effluent or during backwashing cycles. Of those only Cu shows a decreasing trend of about 15% with some scatter (Figure 23).

Based on the information of the elemental composition of GAC_{SS} (Figure 23) and knowledge of the losses over time (Table 11, Table 17, Figure 21), it was possible to estimate elemental concentrations in the effluent. In addition, a “worst case scenario” with 100% loss of GAC was considered. The calculated concentration in the effluent represents some percentages of the permitted limits between 1 to 10%; copper (8%) and phosphorus (10%) being the highest (Table 8). These two elements are also of some concern. Cu is partially leached (Figure 23) and P is already occurring in the effluent of WWTP Altenrhein at levels that are close to the legislation limit (0.3 mg/L).



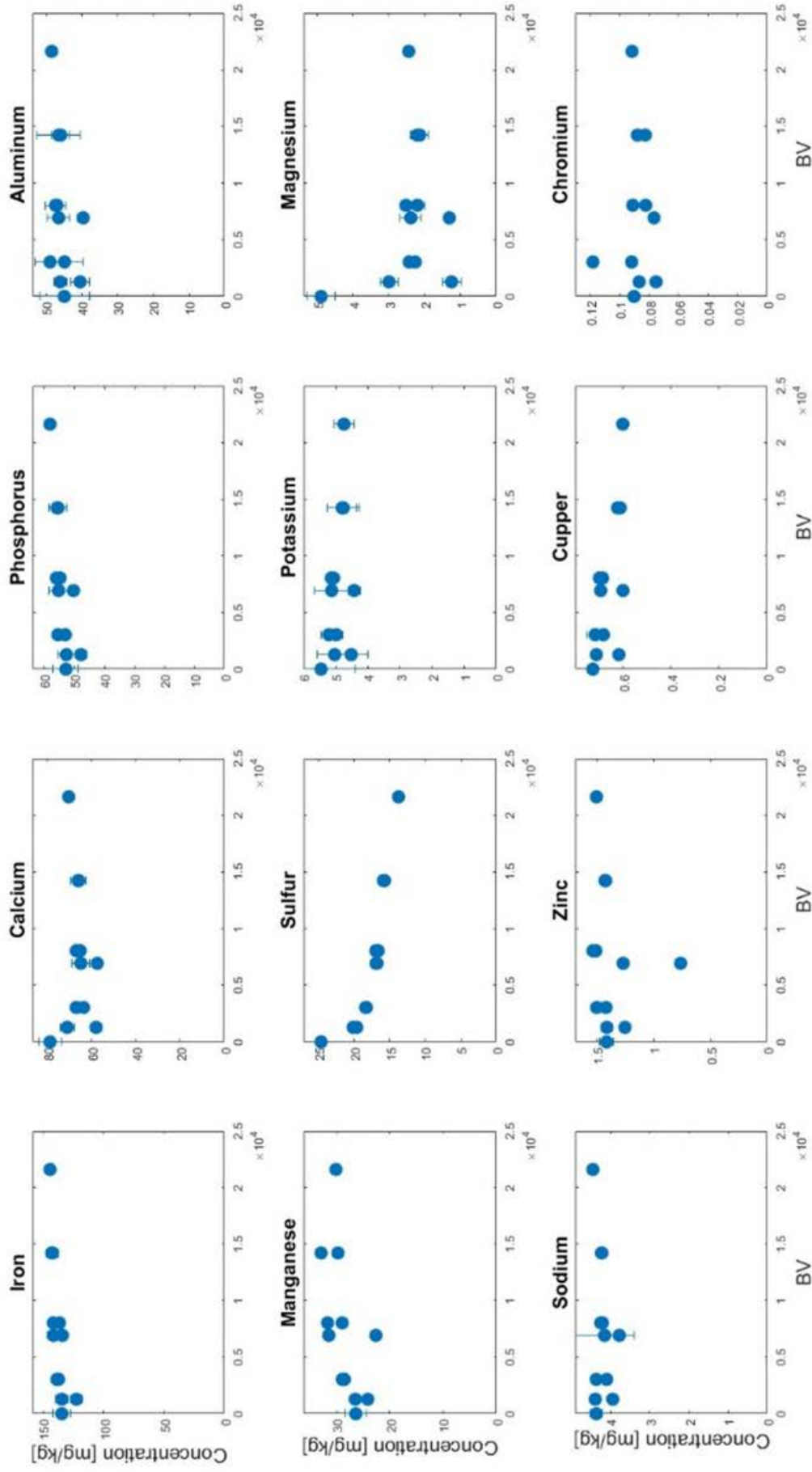

Figure 23 Elemental concentrations of major elements over time in renewable GACs.

After short period of operation, fresh GAC_{SS} became 5-10% harder (see section *Regeneration of spent GAC*), but did not change significantly over the next 14 months.

On the contrary, the particles size distribution changed in favor of bigger particles. The overall contribution of particles with size between 0.5-2 mm decreased by 20%, while particles of 2-3.15 mm increased (see section *Regeneration of spent GAC*). Based on these observations, it is hypothesized that during the initial phase of operation, the weaker material is preferentially lost, leading to an overall harder GAC. During the later phase of operation, no changes in hardness are observed suggesting that the GAC becomes more homogeneous over time and that material lost is representative of the whole.

Organic micropollutants elimination in pilot experiments

In the first phase, GAC_{SS} , and GAC_{CP} elimination of DOC measured by UV_{254nm} and OMPs is inferior to GAC_{REF} elimination. In general, GAC_{SS} appears to be a better absorbent than GAC_{CP} for most of the investigated substances (Figure 24). Candesartan and Venlafaxine representing the only exceptions. GAC_{SS} on average can eliminate 40%-50% of Amisulpride and Citalopram, 40%-50% of Carbamazepine, Hydrochlorothiazide and Metoprolol, 40%-30% of Benzotriazole, Clarithromycin and Diclofenac, and 40%-20% of Irbesartan, Candesartan and Venlafaxine. Based on these observations, GAC_{SS} alone, operated at 20 minutes EBCT, will be insufficient to satisfy the requirements of the Swiss water protection ordinance (i.e., average of 80% elimination over the whole WWTP process train). However, its combination with ozonation at higher O_3 dose than standard (i.e., 0.3-0.4 g O_3 /g DOC) is a technically viable option that merits further development.

Secondary treatment at WWTP Altenrhein abates 10% of OMPs on average. Hence 70% elimination is set as threshold in the combine O_3 and GAC processes to achieve the overall 80% elimination which is the legal requirement for large size WWTP by the Swiss Water Protection Ordinance.

Below two scenarios are proposed to achieve a minimum of 70% OMPs elimination with the combination of ozonation and GAC_{SS} (Table 18), and one scenario with the combination of ozonation and GAC_{CP} (Table 19). The needed O_3 dose was calculated based on the results collected during the study. The corresponding elimination for each of the 12 OMPs was estimated following the approach of Lee et al., (2013 and 2014).



Table 18 *GAC_{ss} filter average elimination over the period at 20 min EBCT and 50 min EBCT, estimated O₃ dose required to achieve the threshold required by the Swiss Water Protection ordinance. And possible scenarios estimated overall elimination through the O₃ and GAC combination in 2 scenarios at standard and enhanced EBCT.*

	HCT	BTA	AMI	MET	SMZ	VEN	CBZ	CITA	CAN	MCP	CLR	IRB	DIC	avg OMPs
Avg elimination at 20 min EBCT [%]	44	26	63	17	7	10	9	44	28	1	27	40	41	28
Avg elimination at 50 min EBCT [%]	38	21	79	13	46	35	50	65	29	-7	44	66	61	42
Desired O ₃ dose [g O ₃ /g DOC]	0.5	0.5	0.5	0.1	0.2	0.3	0.3	0.2	0.5	0.5	0.3	0.3	0.1	0.3
Set dose [g O ₃ /g DOC]	0.3	0.3	0.3	0.3	0.3	0.3	0.3	0.3	0.3	0.3	0.3	0.3	0.3	0.3
Expected elimination at set O ₃ dose [%]	20	20	40	40	80	40	80	40	30	30	60	30	80	45
O ₃ + GAC Elimination 50 min EBCT [%]	58	41	100	53	100	75	100	100	59	23	100	96	100	77
O ₃ + GAC Elimination 20 min EBCT [%]	64	46	100	57	87	50	89	84	58	31	87	70	100	71

Table 19 *GAC_{cr} filter average elimination over the period at 20 min EBCT and 50 min EBCT, estimated O₃ dose required to achieve the threshold required by the Swiss Water Protection ordinance. And possible scenarios estimated overall elimination through the O₃ and GAC combination in 2 scenarios at standard and enhanced EBCT.*

	HCT	BTA	AMI	MET	SMZ	VEN	CBZ	CITA	CAN	MCP	CLR	IRB	DIC	avg OMPs
Avg elimination at 20 min EBCT [%]	6	19	21	3	-2	-7	-	4	7	13	6	4	-	9
Avg elimination at 50 min EBCT [%]	26	37	45	7	-44	6	25	34	13	13	9	20	26	17
Desired O ₃ dose [g O ₃ /g DOC]	0.1	0.5	0.3	0.5	0.5	0.6	0.2	0.5	0.5	0.5	0.5	0.5	0.1	0.4
Set dose [g O ₃ /g DOC]	0.5	0.5	0.5	0.5	0.5	0.5	0.5	0.5	0.5	0.5	0.5	0.5	0.5	0.5
Expected elimination at set O ₃ dose [%]	65	45	80	65	100	65	100	80	60	50	100	60	100	74
O ₃ + GAC Elimination 50 min EBCT [%]	91	82	100	72	56	71	100	100	73	63	109	80	100	84

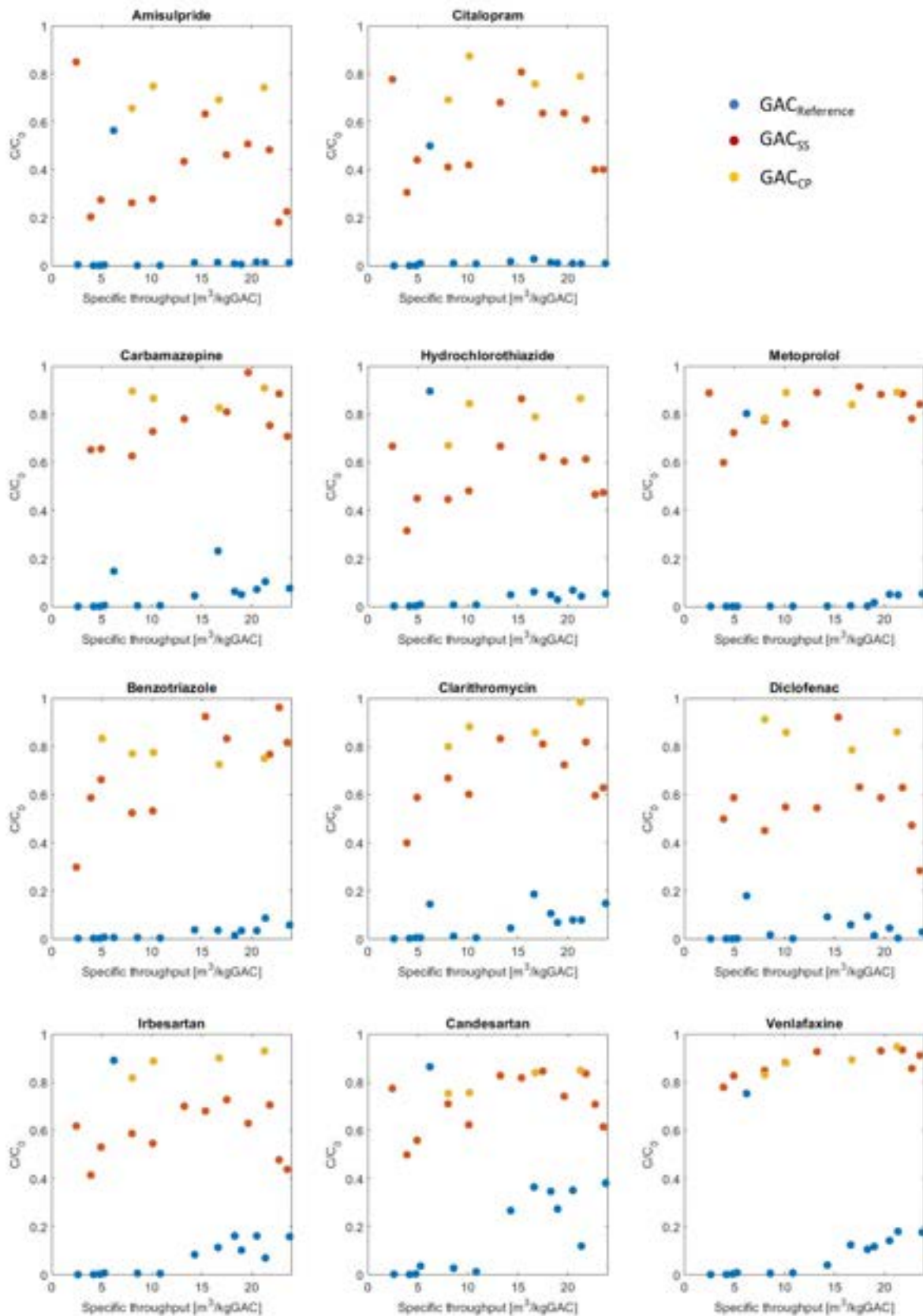

Figure 24 Elimination of selected micropollutants ordered from those with the highest affinity (i.e., Amisulpride and Citalopram) to adsorption on GAC to those with the lowest affinity (Irbesartan, Candesartan, and Venlafaxine) in pilot scale filters with GAC_{ref} , GAC_{SS} , and GAC_{CP}



Characterisation of biological activated carbon (BAC)

GAC and ozone + GAC micropollutant elimination show a decline in their capacity to abate OMPs over time. This decline reaches a plateau, especially for the ozone + GAC system. This behavior is different from the saturation of the absorption capacity and can be explained by the elimination of micropollutants and other adsorbed compounds by the biofilm developing on the GAC (Gibert et al. 2013). Understanding the diversity of microorganisms may shed light on their contribution in micropollutant elimination.

Thus, we classified bacteria based on the conserved 16s rRNA gene. DNA was extracted from GAC at different time-points from the three GAC columns (GAC_{Ref}, GAC_{SS}, and GAC_{CP}). Earlier analyses had shown that the bacterial community is similar at different heights, so a mix of top and bottom samples was used. Samples where sufficient DNA could be extracted (only cherry pit and conventional GAC) were sent to a sequencing facility. The distribution of bacterial phyla remained relatively constant between 7 and 18 months of operation in case of the 401V GAC (Figure 25).

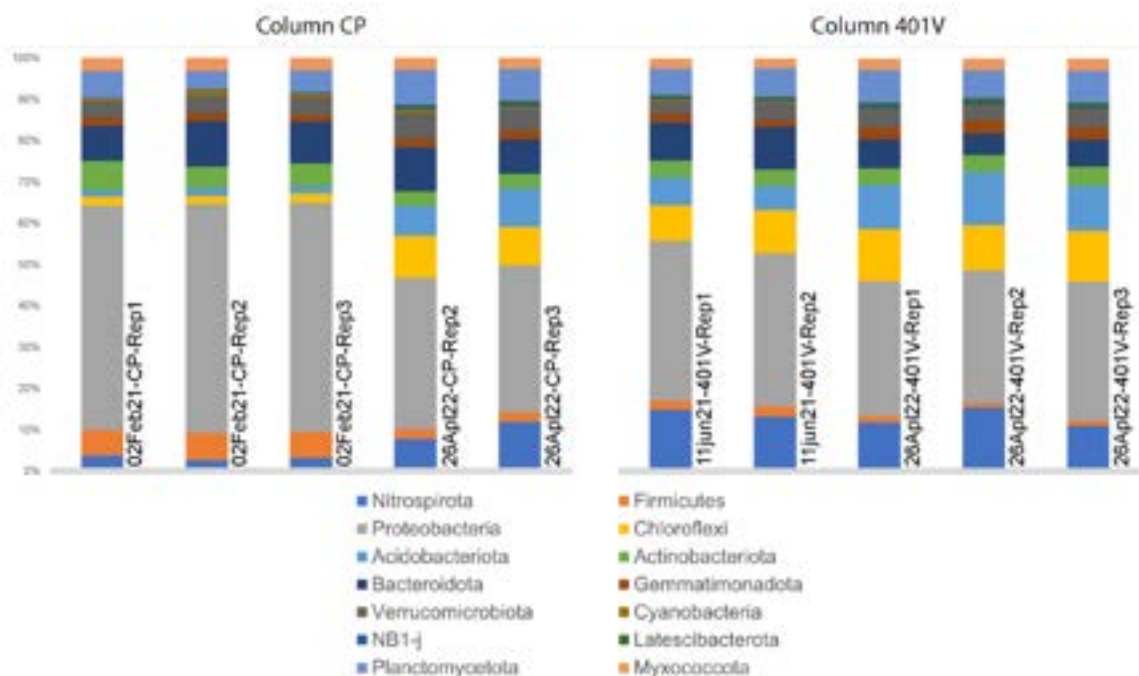

Figure 25 Relative abundances of some bacterial phyla in biofilm from cherry pit GAC (CP) and conventional GAC (Chemviron 401V). 3 CP replicates collected after 3 months of operation and 2 replicates after 18 months of operation. 2 401V 2 after 6 months of operation and 3 replicates after 18 months of operation.

On the other hand, in the GAC_{CP} the phyla Nitrospirota, Chloroflexi, and Acidobacteriota increased between 3 and 14 months of operation and the abundances of Proteobacteria, Firmicutes, and Actinobacteriota diminished. The repartition of phyla was different between the columns in the earlier samples suggesting different physical properties for bacterial attachment or colonization. These differences mostly disappeared in the end of the pilot experiment.

The changes in phyla may be correlated with the micropollutant elimination data. It may also present the opportunity of exploring the contribution of biotic (organism driven) and abiotic (surface, carbon types, pH, temperature etc.) factors in micropollutant elimination.

To monitor the development of biologically activated carbon and to quantify biofilm growth on GAC, thermogravimetric analysis (TGA) was performed on GAC samples collected over time.



Measurements revealed a progressively increasing contribution over time of the mass fraction being volatilized between 250 and 350°C under N₂ atmosphere (Figure 26). GAC_{Ref} fraction burned under O₂ atmosphere decreases and the ash fraction increases. These fractions are fairly constant for GAC_{SS} and GAC_{CP}. It is hypothesized that suspended particles accumulation over time and growth of biomass is responsible for changes in GAC composition. Future investigation should pursue the quantification of growing biomass combining TGA and ATP measurements (see Boon et al. 2008, and Velten et al. 2007).

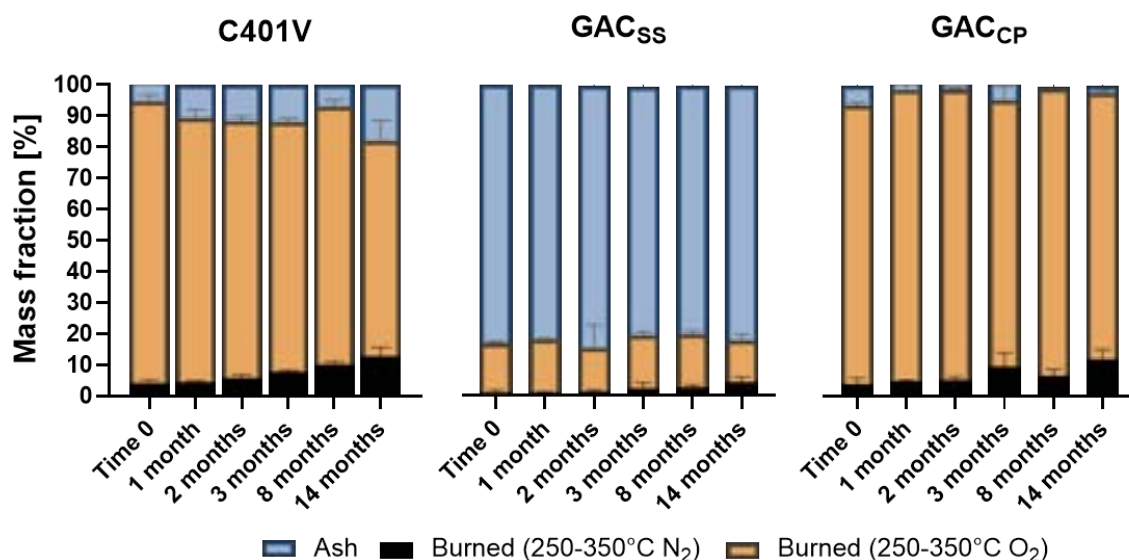

Figure 26 Results from thermal Gravimetry analysis of GAC_{Ref}(C401V), GAC_{SS}, and GAC_{CP} over time

Regeneration of spent GAC

Spent GAC_{SS} after 14 months of continuous operation was pyrolyzed at in to demonstrate the feasibility of regeneration. For this purpose, the Pyreka plant was used with lower dosage of activating agent. SS was reactivated with 10%, 20%, and 50%¹ CO₂ at 800°C for 20 minutes, and CP with 10%, 20%, and 50% of H₂O at 900°C for 10 minutes. Samples after regeneration were characterized for particle size distribution, hardness, thermogravimetric analysis, and adsorption capacity by isothermal experiments using UV₂₅₄, as proxy for direct micropollutants measurements.

After regeneration, the hardness of GAC_{SS} decreases from 87% to 77% and 72% when 20% and 50% CO₂ was used (Figure 27a). The same trend is also observed with GAC_{CP}; hardness decreases from 74% to 63% when using 20% and 50% of activating agent.

Regeneration of spent GAC_{SS} leads to partial breakdown of larger particles (2-3.15mm) into smaller ones; 38%, 19% and 17% when 10%, 20% and 50% of the activation gas was used respectively (Figure 27b). However, the contribution of the smallest particles (<0.5 mm) remains low; 1.9% at 10% CO₂, and negligible at 50% CO₂.

¹ The amount of activating gas is expressed mole fraction of activating agent per mole of carbon in the system during pyrolysis and activation. Doses were calculated based on the average concentration of carbon in sewage sludge (0.25 g C/g), and in cherry pits (0.48 g C/ g) (N. Hagemann et al. 2018).



Burn off during regeneration was considerably lower than observed during pyrolysis and activation of raw materials. During regeneration of GAC_{SS} 3% was burned at 10% and 20% CO₂, and 6% was burned at 50% CO₂. During regeneration of spent GAC_{CP}, burn off was 10%, 22%, and 34% using 10%, 20% and 50% H₂O. The differences between GAC_{SS} and GAC_{CP} burn off are attributed not only to the different starting material, but also to the choice of activating agent, and activation temperature.

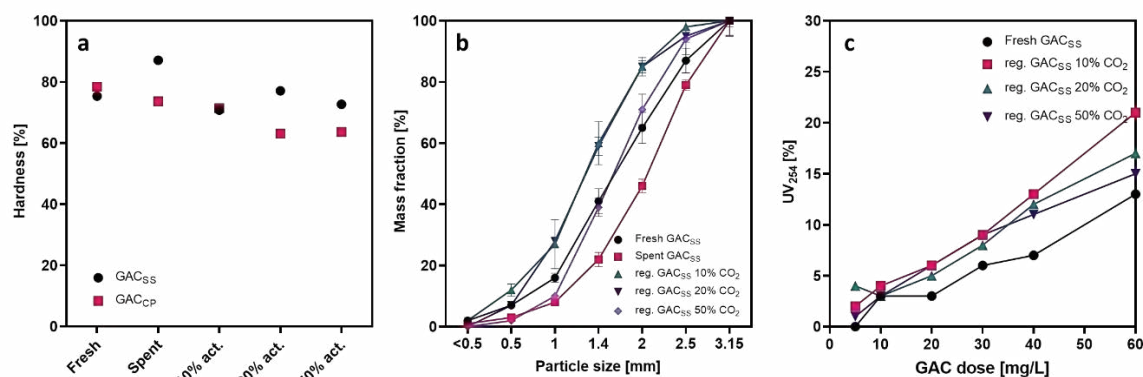

Figure 27 a) Hardness of Fresh GAC_{SS} and GAC_{CP}, spent GAC_{SS} and GAC_{CP}, and regenerated GAC_{SS} and GAC_{CP} using 10, 20 and 50% activating agent. b) Particles size distribution of fresh GAC_{SS}, spent GAC_{SS}, at the end of the pilot experiment as well as after regeneration with 10, 20, and 50% CO₂ at 800°C for 20 minutes. c) Adsorption isotherms with GAC_{SS} reactivated with 10, 20 and 50% CO₂.

When assessing the technical and economic feasibility of regeneration, the estimation of GAC loss must include the loss due to burn-off and the generation of fines that are washed away during the first period of operation. Hence, the operational costs must include additional costs needed for replenishing the filter bed with new material.

The adsorption capacity after regeneration was demonstrated via isotherm experiments measuring adsorption of UV₂₅₄ as proxy for micropollutants elimination (Anumol et al. 2015, Zietzschmann et al. 2014) on GAC_{SS} only (Figure 27c). Regeneration is considered successful, since regenerated GAC shows higher adsorption than fresh GAC. GAC with the lowest dose of CO₂ (i.e., 10% CO₂) displays the highest elimination among the tested conditions, almost twice as high as fresh GAC. Elimination of UV₂₅₄ being a proxy, direct OMPs measurements are needed to confirm these promising results.

2.2.8 Comparison of the baseline situation and the NextGen KPIs

Typical key performance indicators for the evaluation of the quality of production and efficiency of the adsorbent are the active surface quantified via the Brunauer-Emmet-Teller (BET) method, the porous volume by the Barret-Jower-Halenda (BJH) method, the hardness of the material.

The renewable sewage sludge GAC has only a fraction of the active surface of the conventional GAC (Table 20) and also the pore volume is smaller. It has a good hardness suggesting good resistance to typical stresses in fixed bed contactors. The combination of ozonation and GAC system with conventional GAC has a very long service life that is typically attributed to the



development of biological processes using biological activated carbon filters (BAC). The pilot experiment of Nextgen showed that also GAC_{SS} has a service life of over a year. During operation of a granular activated carbon filter, the major parameter affecting the performance of the filter is the empty bed contact time (EBCT). Additionally, the conditions of backwashing and the frequency of backwashing cycles shall also be considered to minimise loss of adsorbent and extend the lifetime of a filter.

Table 20 Comparison of properties and performance of renewable GAC (SS=sewage sludge; CP=cherry pits) and conventional GAC

Parameter	Units	Baseline	NextGen	Reference
Active surface (BET)	m ² /g	800-1200	46 GAC _{SS} 700 GAC _{CP}	Henning and von Kienle (2010), Loreggian (2021)
Pore volume (BJH)	cm ³ /g	0.307- 2.127	0.2 GAC _{SS} 0.4 GAC _{CP}	Pelekani et al. 2000 Loreggian (NextGen, 2021)
Hardness of the material (ASTM D3802)	%	>95	90 GAC _{SS} 60 GAC _{CP}	Loreggian (NextGen, 2021)
Bed volumes for 80% micropollutant removal at 20 min EBCT 0.3 gO ₃ /(g DOC)	BV	>100000	34000 (GAC _{SS})	Loreggian (NextGen, 2021)

2.2.9 Lessons learned for technology operation

Required competence	
A trained wastewater treatment foreman with training on the job can operate the plant. Safety training for the use of ozone is necessary.	
Maintenance	
Plant maintenance is not required. Manual process control and unforeseen events requires about one hour per day and for this no external experts are required. Monitoring of GAC losses over time is recommended. If occurring, optimisation of the backwashing cycles are needed. Standard conditions may not apply for renewable GAC with lighter densities. In this case, longer settling time is suggested in between cycles.	
Technological risks	
Downtimes are rare. They are caused by failures of sensors, e.g. O ₃ sensor, controllers. Such failure can be caused by low water flow. Downtimes typically last 0.5 h and can be solved without external experts.	



2.2.10 Best practice guideline to design and operate the technology

Beside the classic design factors to be considered (i.e. number of person equivalent, average flow rate, flow regime during extreme rain weather events...), the design of fixed bed contactors with renewable GAC shall consider the specific properties of the adsorbent, namely the adsorption capacity and the density of the GAC.

If a less powerful adsorbent is chosen, the reduced adsorption capacity shall be compensated via the construction of larger contactor, or more contactors in parallel. Alternatively, a higher EBCT can be achieved by a reduced flow through the filter. However, this results a lower volume treated per unit of time.

Filling of the bed it is typically done by wetting the GAC and pumping the suspension into the bed to minimize the generation of dust and losses of material. This procedure is applicable for GAC with similar density and particle size distribution (i.e. 0.4 mm -2 mm) as commercially available carbon. GAC with higher densities and bigger particles are harder to pump. Hence, manual filling of the bed may be considered as alternative.

The performance of GAC filters is affected by EBCT (Table 21), a longer EBCT allows for longer equilibration between adsorbate and adsorbents, increasing the chance of adsorption and thus improving elimination. As mentioned above, choosing the appropriate EBCT is a tradeoff between the desired quality of the effluent and the volume that needs to be treated. The experience within NextGen suggests that a more frequent sampling during the startup phase may be required to adjust the EBCT to achieve the desired elimination (i.e. up to 50 min EBCT). When GAC is installed as post-treatment after ozonation, a higher ozone dose (i.e. up to 0.5 g O₃/g DOC) may be considered to compensate for the lack of adsorption in the filter.

Table 21 Comparison of conventional operating conditions with NextGen optimised conditions

	Conventional operating conditions	NextGen optimised conditions	Concerns
O₃ dose	0.1 -0.3 gO ₃ / g DOC	0.3 – 0.5 gO ₃ / g DOC	<ul style="list-style-type: none"> • Higher energy and oxygen consumption • Increased ecotoxicity
EBCT	15-20 minutes	20 – 50 minutes	<ul style="list-style-type: none"> • Larger amount of GAC necessary • Larger contactors necessary



2.3 Biochar, oil and gas production via sludge pyrolysis in Timișoara (RO)

Authors: Mihai Grozavescu (Aquatim), Marcel Murariu (Aquatim), Bogdan Radu (Aquatim)

2.3.1 Description of the demo site

Aquatim SA is a regional operator for water/wastewater services for the Timis county. The served population is around 539.500 inhabitants. The wastewater treatment plant Timisoara services the city of Timisoara and the adjacent settlements. The maximum treatment capacity of the plant is 3.000 L/s. The plant is designed for 440.000 PE.

The first wastewater treatment plant in Romania was built in Timisoara in 1911. The new wastewater treatment plant was commissioned in 2012. It was designed to eliminate carbon, nitrogen and phosphorus including a sludge treatment. The sludge volumes generated are big: around 13.100 m³/year. The design of the wastewater treatment plant includes an extended aeration, this leads to the big quantities of the generated sludge. The depositing of this quantity creates problems, because there is not enough space for this quantity. Thus, solutions must be found to drastically reduce the sludge quantities. The produced sludge has around 30% dried substance and is now deposited. The wastewater treatment plant Timisoara receives the whole sludge quantity of the operating area.

An adequate solution for the wastewater sludge must be found. One solution is the pyrolysis of the sludge. Using this technology, the quantity could be drastically reduced. Aquatim began a case study together with Fraunhofer Institute. There, the sludge was thermally treated, to study the quantity and quality of the obtained products (oil, char and gas). The demo site is located within the Fraunhofer Institute for Environmental, Safety, and Energy Technology UMSICHT. The demo site is in an experimental facility, along with other pilot plants.

2.3.2 Motivation of implementing circular economy solutions in the water sector

Regarding the reduction of natural resources, durable and sustainable solutions must be prioritized. The produced sludge in the wastewater treatment plant can be energetically exploited, using different methods. This is a positive aspect, because the costs of sludge removal are very high. The environmental impact of depositing the sludge is also significant. The cost of energy is rising, thus the solution of energy recovery becomes interesting.

In the recent years, extensive research has been carried out on the transformation of biological wastes into biofuels and biorefineries through pyrolysis, which may gradually be replacing the crude-oil resources Elmously et al. (2019).



2.3.3 Action and case study objective

Table 22 Action and objective regarding material recovery in Timișoara

Case Study & Subtask	Technology baseline	NextGen intervention in circular economy for water sector	TRL	Capacity	Quantifiable target
#10 Timișoara Romania Sub-task 1.4.6	Dewatering of excess sludge to 30% DM and depositing	Thermal treatment of sludge resulting in the production of oil/char/gas	TRL 4	6kg sludge/experiment with on average: -char 41.05% -oil 6,24% -gas 52.71%	Biogas/oil/char production depending on different temperatures inside the postreformer. >20% increase share of recovered chemical energy for wastewater treatment and water reuse together

2.3.4 Unique selling points and benefits

Unique selling points for the implementation of a thermal treatment of the sludge from the WWTP Timișoara:

- Major reduction of the sludge volume (~78%)
- Using the obtained biogas instead of the natural gas, for the generation of electrical energy inside the WWTP Timișoara, which leads to reduced operating costs
- The current technology of the WWTP Timișoara does not include any digesters. This means that at the moment WWTP Timișoara isn't able to produce any biogas. Using this technology a lot of gas will be produced.
- Major cost reduction with the transportation and depositing of the final products, because of the major reduction of the sludge volume
- Future usage of the char, not as a waste, but as a reusable product

The TCR technology stands out from other pyrolysis processes due to its high energy efficiency, a wide range of input materials (sludge from WWTP being one of them) and, above all, high product quality. The heat required to operate the TCR plant is generated from the residual biomass (sludge from Timișoara WWTP).

The process ensures high operational stability by preventing dust and tar formation and can process feedstock with moisture levels of up to 30%. At the same time, it provides heat for pre-drying biomass with a moisture content of over 50%. About 75% of the energy from the calorific value of the feedstock is used in the products. If the heat provided for biomass drying is taken into account, around 90% of the energy used is available for sustainable use.

2.3.5 Principal and main characteristics of the technology

Pyrolysis is the heating of an organic material, such as biomass, in the absence of oxygen. Biomass pyrolysis is usually conducted at or above 500 °C. Because no oxygen is present



combustion does not occur, rather the biomass thermally decomposes into combustible bio-gases, bio-oil and bio-char. Most of these combustible gases can be condensed into a combustible liquid, called pyrolysis oil (bio-oil), though there are some permanent gases (CO₂, CO, H₂, light hydrocarbons), some of which can be combusted to provide the heat for the process. Thus, pyrolysis of biomass produces three products: one liquid, bio-oil, one solid, bio-char and one gaseous, syngas. The proportion of these products depends on several factors including the composition of the feedstock and process parameters (Agricultural Research Service, 2021). The TCR 2 thermo-catalytic process is a variant of the pyrolysis technology. The Thermo-Catalytic Reforming (TCR[®]) is an intermediate pyrolysis combined with a unique integrated catalytic reforming step (Daschner 2022). In the “thermo-catalytic reforming” (TCR[®] process), the sludge is converted into synthesis gas, bio-char and liquid bio crude oil, which forms the starting material for synthetic fuels.

In a first stage, the sludge is gently broken down into biochar and volatile components in a continuously operating screw reactor in the absence of oxygen at medium temperatures (< 500 °C). The formation of tar and other pollutants is prevented by optimised process conditions in the various reactor zones. Second stage: In a post-reformer, the coal and vapors are catalytically refined further at temperatures of up to 850 °Celsius to improve gas yield and product quality. The vapors are then cooled. During condensation, oil and process water are separated. The remaining gas is cleaned (Daschner 2022).

A lab-scale TCR[®] plant designated as TCR[®]-2 was used for the thermochemical conversion of the sewage sludge pellets. The experiment involved two main stages: intermediate pyrolysis in a horizontal auger reactor and a catalytic reforming process in a vertical postreformer. Throughout the experiment, nitrogen was passed through the plant as a purge gas.

Figure 28 shows the scheme of the lab-scale plant and Figure 29 shows pictures with its basic and measurement components. The basic components are:

- 1 Feed hooper
- 2 Feeding screw
- 3 Reactor
- 4 Postreformer 1
- 5 Postreformer 2
- 6 Condenser unit
- 7 Cooling system
- 8 Electrostatic precipitator (ESP)
- 9 Outlet screw
- 10 Coke container
- 11 Heating corper

The measurement components are:

- 12 Gas Analyser M&C
- 13 Gas flowmeter
- 14 Rotary switch sensor (level sensor postreformer)
- 15 Level sensor coke container
- 16 Pressure sensor
- 17 Thermo-elements
- 18 Nitrogen distributor system
- 19 Electronic (control cabinet plant)



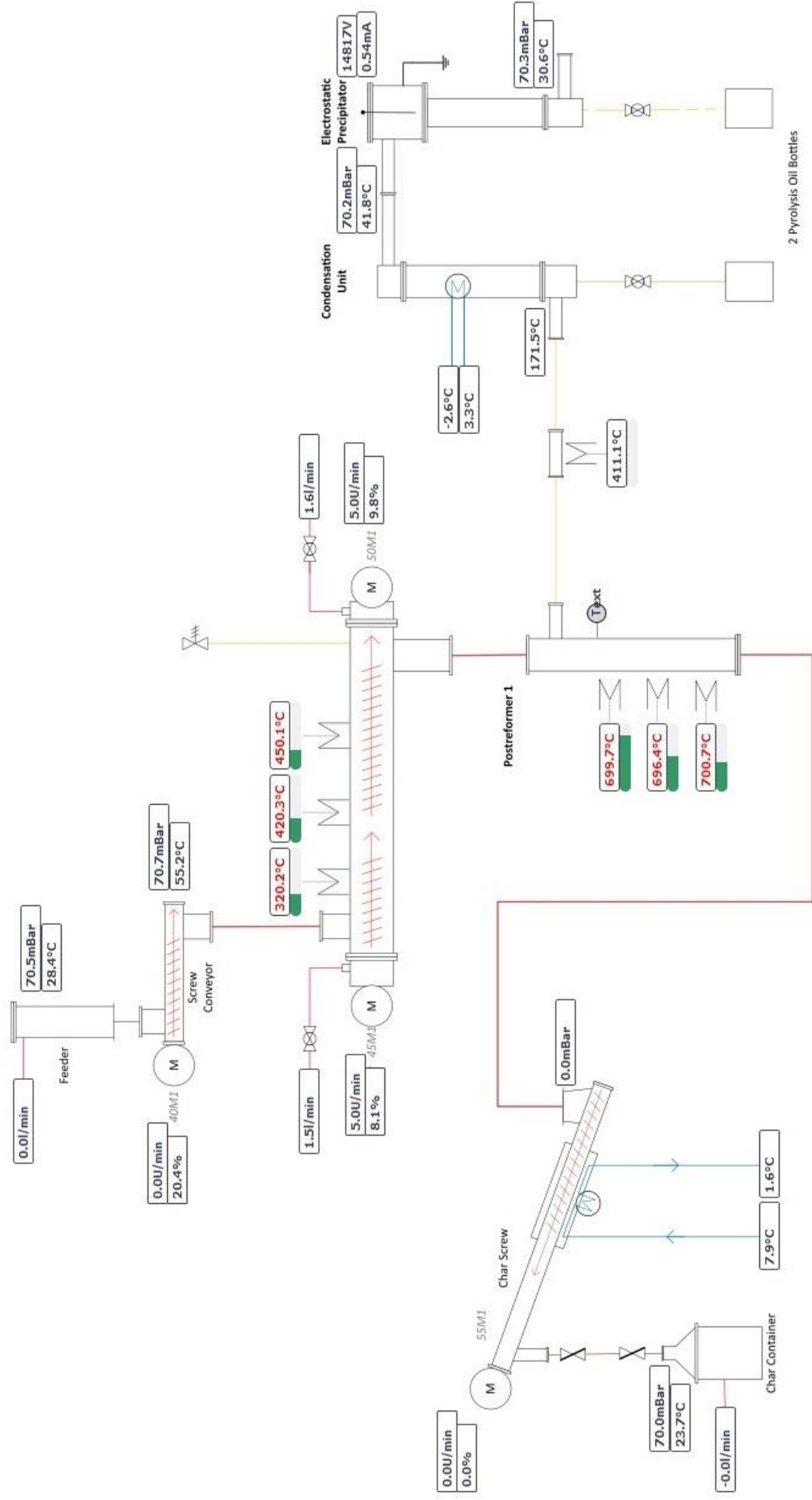

Figure 28 Scheme of the lab-scale TCR® plant

In Figure 29, the security components (20, 21), the gas-base/acid washer (22), different valves (23-29) and motors (30-33) are also indicated. Furthermore, the plant has a capacity of 2kg/h with a nitrogen and propane supply.

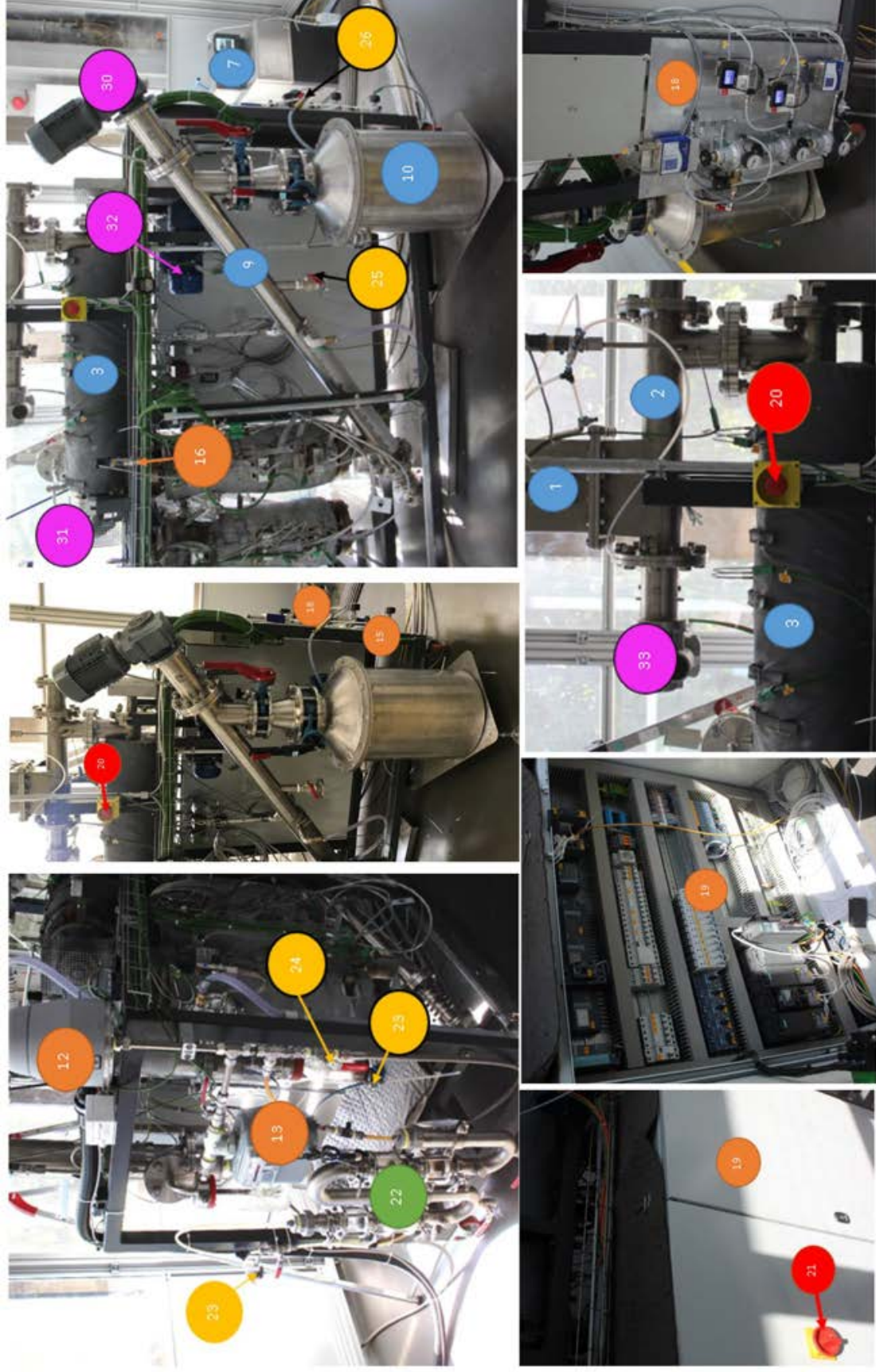

Figure 29 Lab-scale TRC® plant

This project has received funding from the European Union's Horizon 2020 research and innovation programme under grant agreement N°776541



2.3.7 Results: batch tests in thermos-catalytic reforming plant (TCR2)

The analysed sewage sludge at Fraunhofer UMSICHT came from Aquatim. Further treatment (pelletising) was required for processing the feedstock in the TCR lab unit. Figure 30 shows a scaled picture of the feedstock before pelletising (on the left) and. Of the pelletised sewage sludge (on the right).



Figure 30 Left: feedstock before pelletising; right: pelletised sludge

Proximate and ultimate analyses were carried out on the feed stock to ascertain its elemental composition (C, H, N, S, O) and higher heating value (HHV) as well as its moisture and ash contents. The results are shown in Table 23.

Table 23 Feedstock characterisation

Ultimate Analysis					Proximate Analysis			
N	C	H	S	O*	HHV	Ash Content	Moisture Content	Bulk Density
(wt. %)	(wt. %)	(wt. %)	(wt. %)	(wt. %)	(MJ/kg)	(wt. %)	(wt. %)	(kg/m ³)
2.95	18.66	3.57	0.70	20.24	7.799	53.58	7.43	1035.45

The parameters for the experiments are shown in Table 24.

Table 24 Experimental parameters

Names	Aquatim	Aquatim	Aquatim	Aquatim	Aquatim	Aquatim
Trial	V69	V70	V71	V72	V73	V74
Feed	Sewage sludge pellets	Sewage sludge pellets	Sewage sludge pellets	Sewage sludge pellets	Sewage sludge pellets	Sewage sludge pellets
Date	31.05.2022	02.06.2022	07.06.22	09.06.2022	13.06.2022	15.06.2022
Throughput [kg/h]	2,1	2,1	2,1	2,1	2,1	2,1
Temperature of the reactor [°C]	450	450	450	450	450	450
Temperature of the postreformer [°C]	850	750	500	800	550	700
Annotation	no irregularities	no irregularities	no irregularities	no irregularities	no irregularities	no irregularities



Figure 31 shows the mass balances from the experiment, showing the yields of the different products. Due to the small scale of the pilot plant (only 6kg per batch), some of the material remains inside the small tubes, inside the postreformers and on the outlet screw. This leads to less than 100% of recovery.

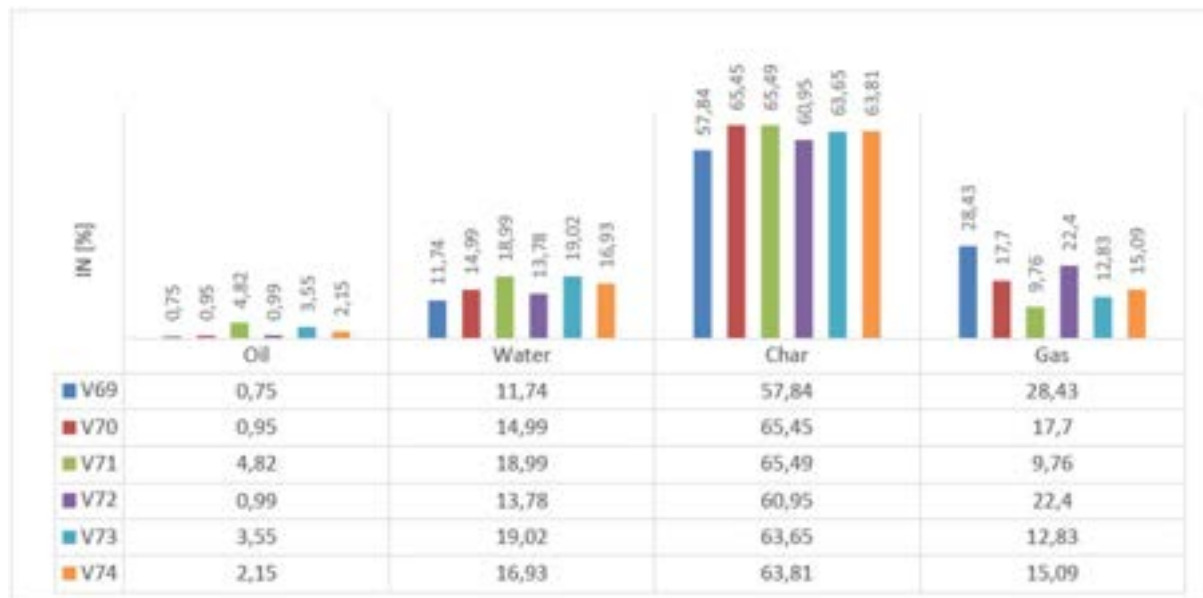

Figure 31 Mass balance (values given in mass-%)

Table 25 and Table 26 show the proximate and ultimate analysis of the char and the oil, respectively, while Table 27 shows the gas compositions as recorded by an M&C Gas Analyser. Since the M&C Gas Analyser has a cross interference, especially for the measurements of CO, CO₂ and CH₄, a sample of the gas was taken for each experiment. The sample was analysed for compositions using gas chromatography (GC). The results from the GC confirm the measurements from the gas analyser (Table 27).

Table 25 TCR-char characterisation

Experiment	N	C	H	S	O*	Ash content	HHV
	[wt. %]	[wt. %]	[wt. %]	[wt. %]	[wt. %]	[wt. %]	[MJ/kg]
V69	1.35	14.15	0.51	0.61	-1.41	84.79	5.303
V70	0.94	15.00	0.30	0.94	-1.50	84.6	-
V71	1.81	14.30	0.80	0.65	2.00	80.4	-
V72	0.83	13.70	0.30	0.68	-1.60	86.1	-
V73	1.69	14.70	0.70	1.69	1.00	81.3	-
V74	1.25	14.80	0.50	0.69	-0.90	83.8	5.228



Table 26 TCR-oil characterisation

Experiment	N	C	H	S	O*	Water content	HHV	TAN
[-]	[wt. %]	[wt. %]	[wt. %]	[wt. %]	[wt. %]	[wt. %]	[MJ/kg]	[mg KOH/g]
V69	7.69	70.20	6.00	1.90	6.10	6.60	33.68	11.62
V70	9.50	76.20	6.50	1.00	5.50	1.00		
V71	8.48	75.66	9.19	1.19	5.49			
V72	9.43	73.25	6.90	1.15	9.26	3.03	34.14	8.51
V73	8.07	71.50	8.20	1.10	7.40	3.10		
V74	9.76	71.60	6.70	1.00	4.60	6.20	33.51	10.91

Table 27 Gas composition from gas analyser (note: GC results in Figure 32 are more reliable)

Experiment	H ₂	CO	CO ₂	Rest CxHy
[-]	[wt. %]	[wt. %]	[wt. %]	[wt. %]
V69	51.33	17.91	12.83	17.93
V70	49.50	14.66	14.24	21.61
V71	11.04	4.78	24.17	60.01
V72	52.40	20.50	12.00	15.10
V73	31.20	7.80	24.10	36.90
V74	49.90	12.10	18.20	19.80

Furthermore, the composition of the TCR[®]-gas as measured via GC is shown in Figure 32. Again, the hydrogen fraction of the gas depends on the process parameters like the postreformer temperature. For instance, the trials V69 and V72 with the highest postreformer temperatures, 850°C and 800°C, produced the highest hydrogen fractions (45% and 46%, respectively). On the other hand, the trials, V71 and V73, with the lowest postreformer temperature (500 °C and 550 °C) produced the lowest hydrogen fractions (32% and 28%, respectively). Hence, within the limits of experimental errors and postreformer reactions, increased hydrogen production is favoured at high postreformer temperatures.

Finally, the energy balances of the first and last experiments (V69 and V74) are shown in Table 28. To simplify the energy balance, the electrical energy input as well as losses were neglected. Thus, the energies of the fuel-products are given as fractions of that of the feedstock. It was observed that the energy fraction of the oil was slightly higher than its mass fraction because of its high calorific value (about 34 MJ/kg). On the other hand, the energy fraction of the char was much lower than its mass fraction due to its low calorific value (about 5 MJ/kg). Meanwhile, process water did not feature in the energy balance due to its very low HHV.



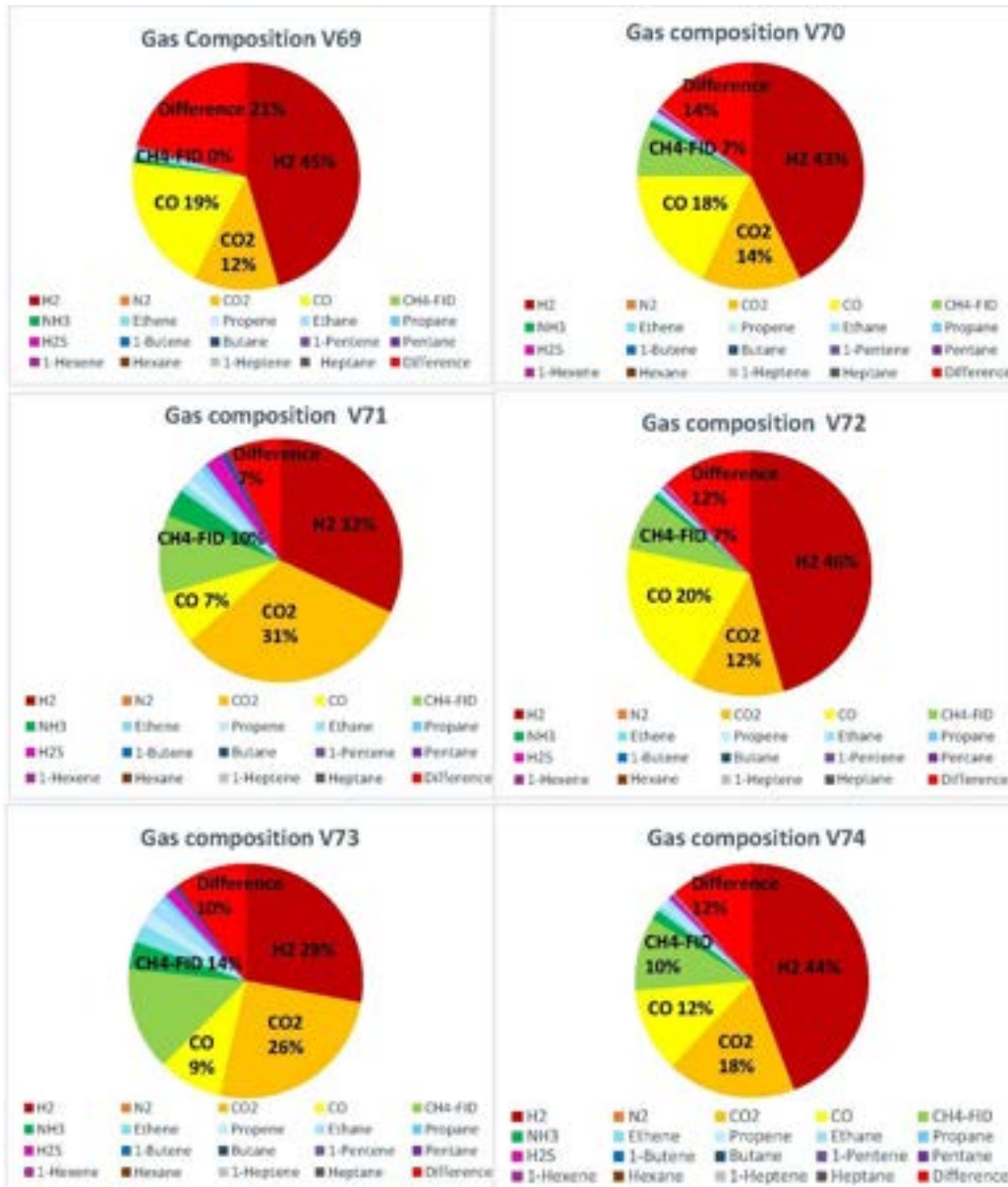

Figure 32 Gas compositions resulting from gas chromatography

Table 28 Energy balance of first and last experiment

Experiment	Char (%)	Oil (%)	Gas*
V69	39.33	3.24	57.43
V74	42.77	9.24	47.99

Conclusions

The feedstock from Aquatim has a high ash content with more than 50 wt-% due to its high inorganic content and, thus, a low gross heating value (less than 8 MJ/kg). Yet, it yields sufficient fuel products. As it were, the mass balance shows a yield of up to 80% of fuel products (char, oil and gas).



Nevertheless, the transfer of energy to very-high energy products (oil and gas) is only about 55%, as seen in the energy balances, since the char is observed to be of low energy value due to high inorganic content. The other two fuel-products (upon analysis) are considered to be of good quality. By and large, the goals of the study, including determining the effect of process parameters (like the post-reformer temperature) on the yields as well as qualities of the products, were achieved.

Therefore, recommendations for further steps are in order. Firstly, economic analysis for industrial scale conversion of sewage sludge using the TCR®-technology are recommended. In addition, determine the best applications for the commercial scale unit – with respect to the most added value for utilisation of gas, oil and char. Due to the high quality of oil and gas, different applications are possible, e.g. the separation of hydrogen from the syngas or the upgrading of oil to standard fuels.

We estimate that the full-scale plant (thermal treatment) will realise a big quantity loss of the sludge (~78%). We also estimate that 3.136 m³ of natural gas/ day can be saved by burning the produced biogas instead.

2.3.8 Comparison of the baseline situation and the NextGen KPIs

Prior to the implementation of NextGen, in the baseline situation, the produced sludge was deposited. This sludge depositing is a problem, because of the high sludge quantities. The sludge has a DS content of about 30%. The quantities and flow rates in the wastewater treatment plant Timișoara (baseline) are shown in Table 29.

Aquatim Timișoara is in the process of building its first wastewater sludge thermal treatment unit. Aquatim chose this process to drastically reduce the sludge quantity. The plant is supposed to begin operation in early 2024. Thus, there aren't any specific data of the thermal treatment process for AQT Timișoara.

Table 29 Current situation (baseline) without any measures identified in NextGen

Parameter		Units	Mean	Frequency and number of measurements	Comments
Flow rates	Wastewater to the WWTP	Flowrate	m ³ /d	122.313	average values for one year; all measurements are done continuously April 2021 - March 2022
	Effluent from the WWTP	Flowrate	m ³ /d	122.871	
	Solids from the WWTP	Massflowrate	t/d	13.870	
N- & P- concentrations & DM and oDM contents	Wastewater to the WWTP	TN	mg N /l	28	
		TP	mg P /l	2	
	Effluent from the WWTP	TN	mg N /l	5,9	
		TP	mg P /l	0,8	
	Solids from the WWTP (sludge)	TN	mg/(kg DM)	45.100	
		TP	mg/(kg DM)	19.667	
	DM	%	30		
	oDM	% DM	58		



The obtained data from the case study will be shown in Table 30. They represent estimates based on the data obtained from the case study.

Table 30 Expected outputs for the Timișoara WWTP due to the planned implementation of the NextGen measures based on the results from the pyrolysis batch tests

NEXTGEN - System				
Parameter		Units		Estimation
Flow rates	Solids from the WWTP	Massflowrate treated	t solids/d	38
Energy produced	Energy obtaiend (gas)	Gas	m ³ /(t solids)	316
		Energy	kWh/(t solids)	1.040
Material produced	Biochar	Massflowrate produced	kg/(t solids)	580
	Oil	Massflowrate produced	kg/(t solids)	8
Quality of the products	fuel(oil, gas)	fuel product out of the volatile component	%	80

During the six experiments done, the temperatures of the postreformer were different. This means that the obtained gas content was different as well. The gas is the desired product to be obtained out of the thermal treatment of the sludge. The obtained gas will be used to generate electrical energy (using a turbine) for the heating process.

Depending on the temperatures in the postreformer (500 – 850 °C), the gas production was between 9.76 – 28.43%. As a rule, the higher the temperature, the more gas will be obtained. The oil can also be reused later to produce biofuel. Depending on the temperature, oil production can be increased or decreased. As a rule, the higher the temperatures in the postreformer, the smaller the oil production. Future possible clients for the obtained biochar still must be found.



2.3.9 Lessons learned

Wastewater sludge has become an important approach to meet the current requirements of energy and oil alternatives. One promising pyrolysis route is the intermediate pyrolysis, which opens the field to the valorisation of a high variety of biological residues into biofuels including gases, liquid chemicals, and carbonaceous residues. In the present work, the Thermo-Catalytic Reforming (TCR) technology based on an intermediate pyrolysis with integrated catalytic reforming was discussed, showing a high productivity and higher quality of biofuels compared to traditional pyrolysis systems.

For the case study, one technology was tested with wastewater sludge from the Timișoara WWTP. The purpose of the investigation was to test if this technology is feasible for the whole quantity of sludge from the WWTP in Timișoara. In this regard, six tests were done with the sludge. The main objective of the case study was to determine the optimal conditions for the gas production. Gas is the desired product for Aquatim, to substitute the necessity of natural gas. The gas will be used to generate electric energy inside the WWTP. The estimative gas volumes that will be produced are around 250 m³ gas/t DM.



Taking into account the calorific values of the natural gas (35.000kJ/m³) and the obtained gas from pyrolysis (11.840kJ/m³), the resulted energy from the pyrolysis gas can substitute around 3.136 m³ of natural gas/ day.

Another major advantage of the thermal treatment of the sludge represents the big quantity loss of the sludge. The reduction of the quantity of sludge is major (~78%). This means lower costs for transportation and depositing mainly of the char (what remains after the sludge thermal treatment). Furthermore, Aquatim will look for solutions to use the resulting char.

Regarding the advantages of this technology, Aquatim decided to start a full-scale thermal treatment plant. At the moment the stage of the full-scale implementation is at the beginning, in the technical designing phase.

Required competence	
<p>Operation of the system may only be carried out by properly trained and instructed persons. Trainings and instructions for staff have to be repeated regularly. The training of the team sent from Aquatim took one week. The training included a theoretical part, where the fundamentals and the working principle were discussed. The instruction included labor protection and specific work safety. After the theoretical part, the team went on to the practical part, where they assisted in the operation of the TCR 2 plant.</p> <p>At least two persons are required for the operation of the system; working alone is prohibited. The operation of the plant includes the preparation (warm up), the operation itself, and the follow-up work (warm down), where the proper functioning was assessed.</p> <p>Safety equipment must be checked before each use.</p>	



<p>Maintenance</p>	<p>LOW  HIGH</p>
<p>Maintenance must be done by a certified person only. The operation was conducted on a pilot scale plant. The plant isn't running the whole year. It is running only when there are batches to be analyzed. This being the case, the maintenance is performed when necessary. Plant maintenance depends on composition and characteristics of the feedstock (dried sludge). The maintenance includes operations such as:</p> <ul style="list-style-type: none"> -visual check of every individual component before the start-up of the plant -cleaning of the sensors of the plant -changing of the condense water containers -changing of the oil containers -preparation of the gas analyzer before the start-up of the plant -checking that the system is empty before starting the plant up -emptying and cleaning of the coke container -short start-up of the plant to ensure the plant is empty for the next batch <p>The duration of the maintenance depends on the necessary operations for the preparation and start-up of the pilot plant. The pilot plant is a small plant, so the maintenance work is often of a short duration, but it may take longer depending on the problems that may appear.</p>	
<p>Technological risks</p>	<p>LOW  HIGH</p>
<p>The plant is operating at high temperatures. Regarding the downtimes of the pilot plant, they are dependent on the number of batches that this plant will analyse. In case of any complications during operation, the plant must be stopped immediately. Press the plant kill switch or the main kill switch to cut the power. However, when possible, try to shut down and cool down the plant in a controlled way. Reasons to stop plant operation immediately:</p> <ul style="list-style-type: none"> - Rapid pressure increase. Maximum plant pressure is 120 mbar! - Sudden loss of pressure (indicating that there is a potential leakage). - ESP break down. - Cooling malfunction. - Ventilation break down. - CO alarm. - CO warner/alarm not functioning properly. - Control software (PC) malfunction (no plant control). - Smoke/fire. - Heavy vibration and/or unusual sounds (e.g. indicating a conveying screw get stuck) <p>The pilot plant was operated by the personnel from the Fraunhofer Institute, hence, no external experts were required.</p>	



2.3.10 Best practice guideline to design and operate the technology

Firstly, an appropriate technology must be chosen. The sludge characteristics must be considered. Then it must be considered what products shall be obtained primarily. Depending on the temperature/retention time, different proportions of gas/char/oil can be obtained. Durable and sustainable solutions for the resulting products must be considered.

The energy/materials consumption must be as low as possible. An important factor that must be taken into account, is the energy regeneration and the possibility of its reuse.

Aquatim is a regional operator, this means that it has many wastewater treatment plants. These plants generate sewerage sludge, each with different characteristics. The quantities are small comparing to the Timisoara wastewater treatment plant. This means the sludge logistics must be considered.

Crucial for the start-up of the plant would be the technology used and the physical location of the plant. Timișoara being by far the biggest regional sludge producer. So it is the best location for the new plant.

The parameters that are crucial for the optimisation of the production process are as follows:

- energy consumption
- energy regeneration/reuse
- reusability of the obtained products (gas, char and oil)
- flue gas treatment
- maintenance/ consumables
- overall safety of the process, because it implies high temperatures/pressures

Depending on the batch characteristics, and the temperature/retention time, we can obtain different proportions of the products (oil, gas and char). As a general rule, the higher the temperature/retention time, the more gas will be obtained. The oil/char content will be lowered proportionally. If the temperature/retention time is lowered, more oil/char will be obtained. Depending on what products are wanted to be obtained, temperatures/retention time will be chosen.

The duration of a batch experiment can be set differently for any given experiment (the duration depends on many factors, such as: the operating temperature, the quantity of the feedstock, the ending of the gas generation). The plant is a pilot plant, so a lot of active process control is necessary. Taking of some of the samples is done manually, the feeding of the batch at the beginning of the process is also done manually.

When running the experiment, it is important to document the following items every 15-30 min:

- a) display of the flow meter
- b) calorimeter values (calorific value and gas density are the most important values)
- c) Unusual disturbances, pressures, etc.
- d) exact time when the gas sample was taken

After the test it is important to document the following items:

- a) exact time and indication of the gas flowmeter when the test was stopped.
- b) weights of the full condensate and ESP bottle(s)



- c) remaining feed in the feed hopper (if not all through)
- d) weight of the resulting coal
- e) weight of catalyst after the test (if used)



3. Protein production from wastewater

Authors: Peter Scheer (Semilla), Radu Giurgiu (Semilla), Ralph Lindeboom (Semilla), Clara Plata Rios (Semilla), Rob Suters (Semilla)

3.1 Description of the demo site

The La Trappe brewery and the OLV van Koningshoeven Abbey, Berkel-Enschot, Noord-Brabant have a vision of living in harmony with Nature. Aim for the coming ten years is to cope with the municipal wastewater and industrial discharged processwater generated on site and increase the potential of water and nutrients recovery for local reuse.

On site the brewery and the cheese factory produce agro-industrial wastewater (240-360 m³/d). The municipal wastewater is originating from about 22 monks continuously present on site, who also take showers. Then, on average 400 visitors arrive each day to ‘Het Proeflokaal’ (restaurant) and there are about 140 additional employees working for the brewery and on the land. In total, a municipal flow of 15-18 m³/d is produced under nominal conditions (pre-, post covid).

Given the characteristics of the urine, black water and grey water source at the Abbey, it is expected to be in between the composition of untreated domestic sewage and concentrated black water with a relatively high concentration of TN, due to a larger urine donation than average.

This study average brewery and cheese factory wastewater characteristics will be included to allow for a comparison with the domestic sewage composition in terms of nutrient recovery, especially since the flow rate is much larger 240-360 m³/d. Brewery wastewater is usually characterised by a highly fluctuating pH (3-12), a relatively high COD concentration of 2-6 g/L, which to a large extent is biodegradable (Table 31) (Rao et al. 2007, Simate et al. 2011). Although the COD concentrations are in line with concentrated blackwater or urine, the water in terms of nutrients is more similar to diluted domestic sewage. Bacterial counts vary widely between 10³ and 10⁸ CFU/(100 mL), but under normal circumstances pathogenic bacteria are not present, since it concerns beverage production.

Table 31 Characteristics of brewery wastewater

Parameter	Value
pH	3-12
Temperature (°C)	18-40
COD (mg L ⁻¹)	2000-6000
BOD (mg L ⁻¹)	1200-3600
COD:BOD ratio	1.667
VFA (mg L ⁻¹)	1000-2500
Phosphates as PO ₄ (mg L ⁻¹)	10-50
TKN (mg L ⁻¹)	25-80
TS (mg L ⁻¹)	5100-8750
TSS (mg L ⁻¹)	2901-3000
TDS (mg L ⁻¹)	2020-5940

Cheese factory wastewater is like brewery wastewater usually also characterised by a very high COD:N:P ratio, although it contains relatively more TN and fats compared to brewery wastewater (Simate et al. 2011, Prazeres et al. 2012).

Many full scale anaerobic digesters are successfully operated on cheese factory and brewery waste water, due to their relatively suitable COD:N:P ratio and relatively low sludge



production in comparison to aerobic waste water treatment alternatives (Simate et al. 2011, Prazeres et al. 2012). It should however be reminded that these systems always require a polishing treatment to meet discharge regulations in terms of nitrogen and phosphorus. However, although the original goal was to test life support inspired systems, design on yellow, black and grey water treatment on this stream, during the project it was decided to exclude the municipal stream.

3.2 Motivation of implementing circular economy solutions in the water sector

The BioPOLUS Metabolic Network reactor (MNR) was introduced and constructed prior to the start of the NextGen project. In practice the MNR is a biofilm reactor in which plants provide a part of the oxygen, due to which the energy use of the system will be lower compared to conventional activated sludge systems. It consists of a serial configuration of different reactor vessels, with different DO-levels, includes a nitrification-denitrification based nitrogen removal (and uptake by plants) and a chemical phosphate removal. The effluent of the system is treated with a Dissolved Air Flotation followed by a microfiltration unit and a UV-based disinfection. Afterwards the water should be at a suitable level for low quality reuse as irrigation water, groundwater infiltration and potentially discharged on surface water. In order to meet the brewery objectives to further close the water cycle, using astronauts way of thinking that targets the very physical limits of water and nutrient recovery, and apply it to the MNR effluent.

Long-term manned Space missions require a very calculated approach towards the physical human requirements in terms of water, food, air and climate control, due to the difficulty and associated costs of sending a mass payload into Space. The European Space Agency (ESA) has been active in the development of regenerative life support systems for long term space missions for decades. In space, the survival of astronauts requires a large quantity of oxygen, water and food, which are very expensive and bulky to be transported. MELISSA, Micro-Ecological Life Support System Alternative, is an international research consortium established to develop autarkic circular life support systems and to gain knowledge on regenerative system, aiming to the highest degree of autonomy and consequently to produce food, water and oxygen from mission wastes.

MELISSA technology consists of an interconnected loop of bioreactors that convert black water, urine and kitchen waste via a liquefying compartment (C-I), a photoheterotrophic compartment (C-II), the nitrifying compartment (C-III) into food for the astronauts, via Photoautotrophic edible "algae" compartment (C-IVa) and the Higher Plants Compartment (C4b) (Figure 33, Godia et al. 2002). The astronauts themselves are considered as part of the engineered loop of bioreactors as the crew compartment (C-V).

Since the MNR, to some extent could represent the Higher Plants compartment, combined with the nitrifying compartment (C-III) and to some extent the liquefaction compartment (C-I), the monks/ beer brewery as the equivalent of the astronauts (C-V), the inclusion of the purple bacteria, remained an open route to explore as an analogue to the C-II. On Earth, purple bacteria are known for their very high yield in terms of conversion of pollutants in to single cell biomass, with very favourable ratio of C/N for protein production (Puyol et al. 2017, Alloul et al. 2018).



So next to the water recovery targets, in terms of :Is it technologically feasible to apply MELISSA technology to close the water cycle the connected aim in terms of nutrient recovery has been reformulated into the recovery of purple bacteria cell biomass. Although purple bacteria biomass, can be valorized in many different ways, the key target investigated within the given time and with collaboration partner (GrowX) to its use as a slow release N-fertiliser in comparison with conventional fertilisers. This would enable direct substitution of fertiliser purchases for the ornamental plant cultivation that takes place on the wider abbey domains.

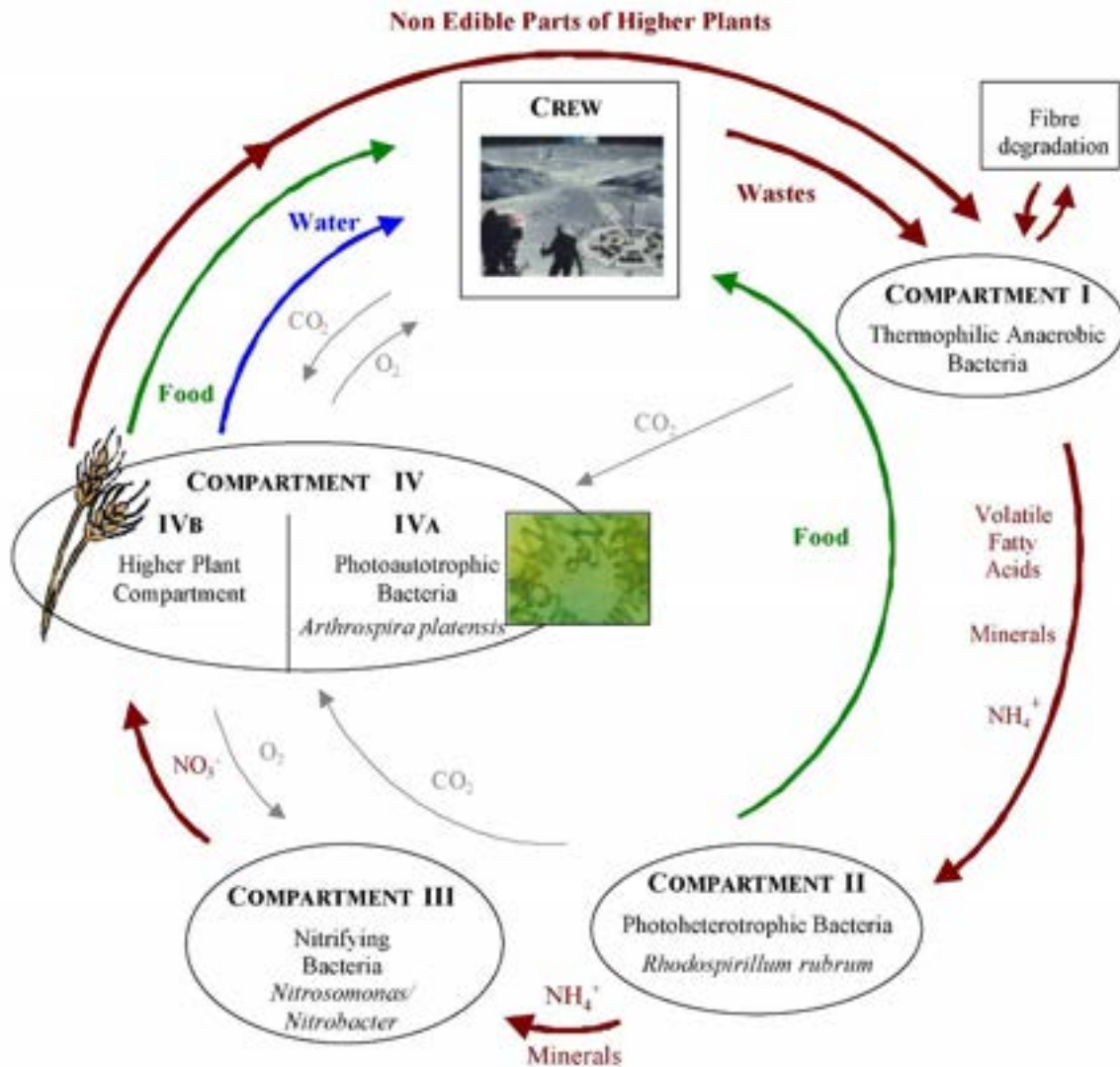

Figure 33 Overview of Micro-Ecological Life Support System Alternative (MELISSA) Lasseur et al. 2011



3.3 Actions and case study objectives

Table 32 Action and case study objective for protein production in NextGen

Case Study & Subtask	Technology baseline	NextGen intervention in circular economy for water sector	TRL	Capacity	Quantifiable target
#6 La Trappe, The Netherlands Sub-task 1.4.4	La Trappe brewery wastewater treatment plant without nutrient recovery	Photobioreactor and “Bio-makery” (utilization of phototrophic organism in real life conditions) for carbon, nitrogen and P-recovery	TRL 4 → 6	60 L/d	Proteins as slow release fertiliser for food production in conditioned growing systems

3.4 Unique selling points

The unique selling points of the photobioreactor in combination with a system such as an MNR and membrane systems are:

- ✓ Integrated upcycling of brine
- ✓ Single cell protein, a value-added compound (containing C and N) for slow-release fertiliser, fodder and potentially other higher end applications

3.5 Principal and main characteristics of the technology

In the case study La Trappe, three different technologies were implemented that are interconnected with each other: the metabolic network reactor, the MELiSSA inspired membrane systems and the MELiSSA inspired photobioreactor. This section focuses on the photobioreactor.

Nitrogen and organic matter are main nutrients contained in wastewater. In wastewater treatment, nitrogen is conventionally removed biologically via nitrification and denitrification. An alternative route makes use of infrared light as energy source, due to which purple non sulphur bacteria can convert volatile fatty acids and ammonia into new biomass, which can be used as single cell protein (Alloul et al. 2021b, Figure 34).

Within the MELiSSA research programme this is also known as the compartment CII. Typically, an axenic photobioreactor (Figure 35) is used for life support engineering purposes, but it has been translated into a pond reactor system for terrestrial applications, in which water is kept flowing using a paddle wheel (Alloul 2018).

After separation and drying, single cell biomass, purple non sulphur bacteria have been proposed for a wide array of potential applications, ranging from shrimp feed to slow-release fertiliser and nutraceuticals. Nutraceuticals are either dietary supplement, such as vitamins or minerals, or products derived from food sources that provide both nutritional and health benefits.



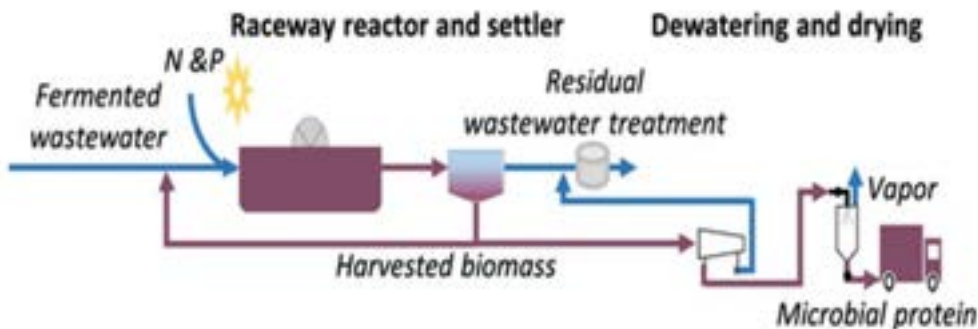

Figure 34 Flow scheme of a MELiSSA inspired purple bacteria reactor (Alloul et al. 2021b)



Figure 35 Pictures of the axenic MELiSSA purple bacteria reactor (Giurgiu et al. 2020)

3.6 Requirements for the implementation of the technology and operating conditions

This section focuses on the photobioreactor. The flow scheme showing the interconnected technologies is given in Figure 36.

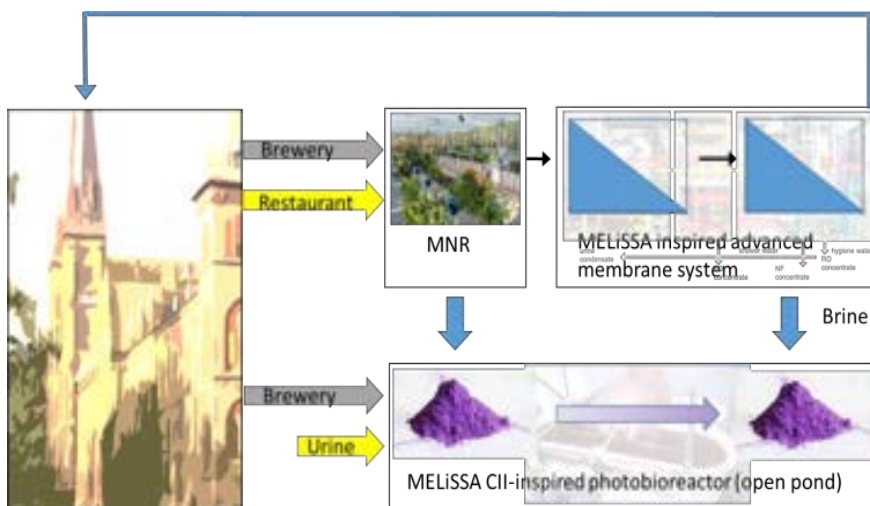

Figure 36 Flow scheme of the NextGen technologies at the case study in La Trappe



In order to achieve nitrogen removal the reactor depth determines the light penetration and thus the efficiency of purple bacteria growth. In Table 33, most important parameters are given.

Table 33 Requirements and operating conditions for purple bacteria in pond reactor system

Parameters	Min	Max	Reference
Influent concentration (mg COD/L)	130	180	Alloul et al. 2019
Effluent concentration (mg COD/L)	50	50	
C/N ratio	~14/1		
Volumetric removal rate (mg/L/d)	390	390	
HRT (d)	0.2	0.3	

The reactor is operated as a sequencing batch reactor (SBR), with a hydraulic retention time (HRT) of about 3 days and a similar sludge retention time (SRT) (Table 34). As in many other experiments presented in the scientific literature, it was set a light/dark phase; in this first attempt a 12/12h cycle was scheduled, simulating daylight conditions. During the light phase the paddlewheel turned at 10 rotations per minute (RPM), allowing for good mixing conditions and a volumetric mass transfer coefficient (kLa) estimated around 1.1-0.8/h. The paddlewheel needs to agitate the water for efficiently mixing the biomass in the raceway reactor and expose it to the light, without including too much oxygen in the system. From figure 33, it is shown that urine addition was anticipated at the La Trappe site. Given the importance of a correct C/N ratio, the first set of experiments were operated with synthetic nutrient addition, while urine was added later for nitrogen supplementation.

Table 34 Settings of the reactor

Summary of raceway reactor configuration, phase 1 and 2			
Mode	SBR	Light/dark phase	12/12 h
Hydraulic retention time (HRT)	3 ± 16 d	Paddlewheel rotation	12/12 h
Sludge retention time (SRT)	3 d	OTR	0.8-1.1 /h

During the night phase, the paddlewheel was turned off, minimising the oxygen transfer rate (OTR) and the biological activity. These conditions were mainly taken as precautions to face two major threats. During the dark phase there is a considerable risk for purple phototrophic bacteria to be washed out, as, in absence of light, they grow at a much slower pace than with light. Secondly, during the dark phase purple phototrophic can be out competed by other microbiological species which can take the lead in the long run. These considerations can be verified in the scientific literature as resulted from the experiments of Alloul et al. (2019, 2021b). However, there are many other conceivable designs and configurations that can be implemented changing some major parameters as: HRT, SRT, light/dark phase and OTR.

3.7 Results: Photobioreactor

The analysis of real wastewater is complex and requires a broader number of measurements. Nevertheless, with the given sampling campaign, much information on the activity of the photobioreactor, also called raceway, could be learned. For instance, focusing on the COD removal, there are many ways to interpret the removal efficiency of the reactor. In Table 35, the different equations are presented.



Table 35 Technical efficiency parameters for the photobioreactor also called raceway reactor

	Name	Equation	Units
EFF_{th,max}	Theoretical maximal efficiency	$(\text{TCOD}_{\text{inf}} - \text{SCOD}_{\text{eff}}) * 100 / \text{TCOD}_{\text{in}}$	%
EFF_r	Real efficiency	$(C_{\text{inf}} - C_{\text{S,eff}}) * 100 / C_{\text{S,in}}$	%
η_s	Apparent efficiency	$(C_{\text{S,RR1}} - C_{\text{S,eff}}) * 100 / (C_{\text{S,RR1}} - C_{\text{S,eff}} * (1 - Q/V))$	%
r_S	Apparent volumetric rate	$(C_{\text{S,inf}} - C_{\text{S,eff}}) * Q / V_r = (C_{\text{S,RR1}} - C_{\text{S,eff}}) / t_{\text{cycle}}$	Kg C _S d ⁻¹ m ⁻³
R_S	Total rate	V _r * r _S	Kg C _S d ⁻¹
X_b	Biomass	TCOD - SCOD	mgCOD L ⁻¹
Y	Yield	$X_b / (C_{\text{SCOD,inf}} - C_{\text{SCOD,eff}})$	gCOD gSCOD ⁻¹
SR	Specific removal rate	r _S / VSS _{eff}	gCOD gV ⁻¹ d ⁻¹

Start-Up of the reactor

The reactor was inoculated with wastewater coming from another operational raceway reactor on site running under similar conditions. Unfortunately, during the previous weeks, because of a spill of a brewing session (16th of November), the wastewaters characteristics had changed significantly, destabilising the microbiological system. As the pictures report below, the wastewater, initially of a pinkish and purplish colour, become more brownish and then greenish. The change of the influent wastewater was observed in an increment of COD, TSS, absorbance, turbidity, and sulphate. Despite the fact that after one week the level of COD returns to more ordinary values, absorbance, turbidity and TSS had remained beyond standards. For these reasons, since the 28th of November, it was thought to dilute by half the influent with drinking water. This countermeasure was taken on the assumption that purple phototrophic bacteria would have been less affected by the scattering and absorbance of light. Over the first week, the reactor was still characterised from the important presence of the greenish bacteria. It is important to mention that until the 2nd of December the influent wastewater was diluted with drinking water. After that day it was possible to gather a standard batch from the equalisation tank at the brewery. Throughout the experiments the colour of the reactor content changed significantly and turned again to have a pinkish orangish taint.

Stable conditions

The results present only the measurements between the 6th and 12th of December, in which urine was used as the source for nutrients and the reactor was already getting to a purplish fade. Despite the downward trend of the influent wastewater characteristics, due to the slow but present biological activity in the IBC tank, the removal efficiency was nearly stable as the average of total COD (TCOD) and soluble COD (SCOD) removal reports between influent and effluent values in Table 36.

Table 36 Total COD removal efficiency calculated between influent and effluent samples. The table reports average weekly variation.

Parameter	Units	Mean
TCOD _{in}	mg COD/L	1609 ± 11
SCOD _{in}	mg COD/L	1362 ± 10
TCOD _{eff}	mg COD/L	830 ± 9
SCOD _{eff}	mg COD/L	260 ± 8
EFF _{th,max}	%	84 ± 2.3



$EFF_{r,SCOD}$	%	81 ± 3
$EFF_{r,TCOD}$	%	51 ± 4

The difference between $TCOD_{eff}$ and $SCOD_{eff}$ is the created biomass. The estimated organic loading rate was estimated at 0.482 gCOD/(L*d). The average maximal removal efficiency ($EFF_{th,max}$) was calculated using the fraction of $TCOD_{in}$ and $SCOD_{eff}$ resulting in around 84%. The removal efficiencies relative to SCOD and TCOD were measured around 80 and 50%, respectively. The calculation according to Equation 1 gives already a rough indication of the biomass yield, which is around 35% and close to the value obtained afterwards. More detailed calculations will follow in the next sections.

Equation 1 Ratio to calculate the biomass yield

$$(EFF_{r,SCOD} - EFF_{r,TCOD}) / EFF_{th,max}$$

Combining all measured samples, it is possible to show the concentration variation in the raceway reactor. In general, in the graphs, the alternating background color of the graphs indicates the difference between the light phase (white from the dark phase in grey, Figure 37 and Figure 38). At the beginning of the light phase, effluent is extracted; then the reactor is fed with influent and urine solutions usually measuring a peak. After five hours of reactions, concentration should have decreased, which gives an indication of the treatment rate. This behaviour was observed precisely with the chemical oxygen demand; but, with nutrients, it was not always the case. For instance, looking at the ammonia variation, there is an accumulation of this compound over the days, probably underlying that the optimal C/N ratio depends on the stability of the inflow concentrations and the competition between various organisms.

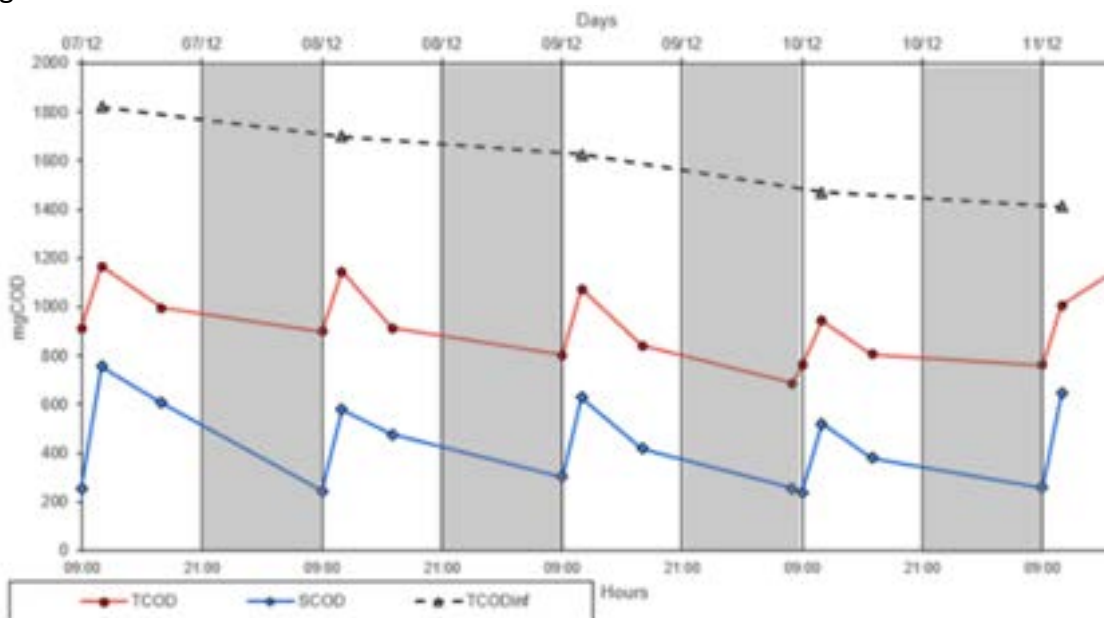

Figure 37 Evolution of TCOD and SCOD in the reactor in the second week of operation in the raceway reactor. $TCOD_{inf}$ is the influent concentration in the reactor (Alloul et al. 2021a)

Regarding phosphate and nitrogen, it is interesting to observe, how their assimilation is somewhat delayed in the first hours of reactions. For phosphate this phenomenon could be related to the typical phosphorus cycle under anaerobic/aerobic condition in which firstly



organic compounds are absorbed by cells at the expense of inorganic polyphosphate (Poly-P), releasing phosphorus to the wastewater. Then, phosphorus is slowly reconverted to new biomass and Poly-P. The reason of such a behaviour should be better investigated under a biological and chemical point of view.

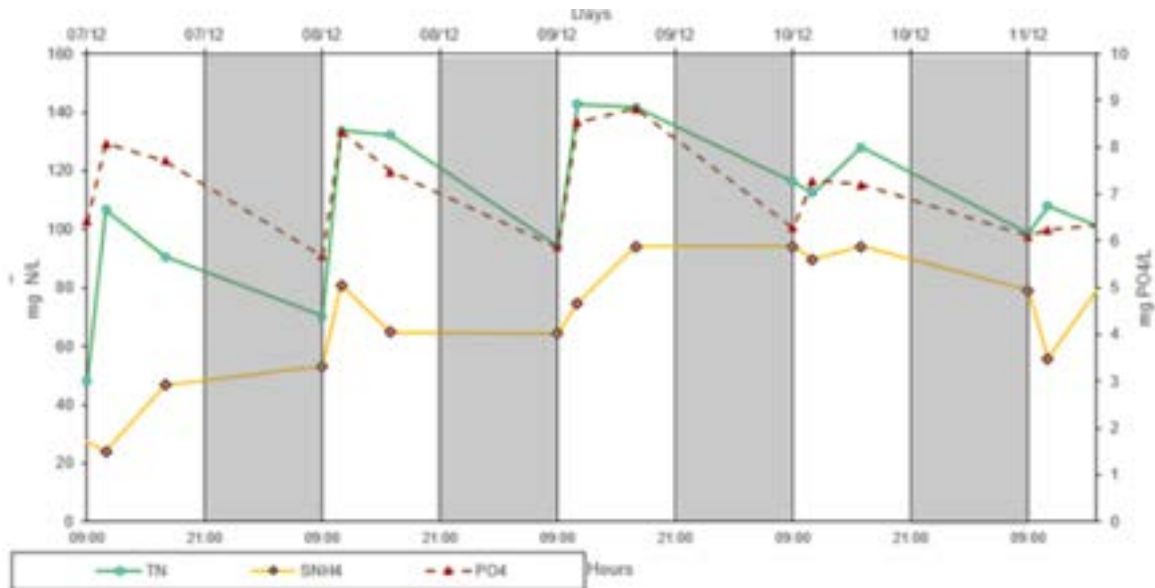

Figure 38 Evolution of total nitrogen (TN) ammonium (SNH₄) and Phosphate (PO₄) in the raceway reactor in the second week of operations in the phase 2

Apart from the evolution of the chemical and biological reactions, the analysis of the performance of the reactor is shown comparing the samples RR1 and EFF. Therefore, the volumetric removal rate (r_s), the apparent removal efficiency (η_s) and the total rate (R_s) were estimated using those samples (Table 37). As before, the row Max refers to the difference between the TCOD and SCOD. Respectively, the COD removal accounted for 820, 276 and 359 mg COD/(L*d) for Max, TCOD and SCOD. Phosphate and total nitrogen removal were estimated around 53% and 49% with a standard deviation of 15 and 25%, respectively. The source of the high standard deviation was not found. Meanwhile, it was not possible to obtain any reliable calculation for ammonium removal. For that reason, urea addition needs to be more understood in its reactions. The TSS generally increased during the reactions phase, indicating the formation of new biomass, but it was obtained a high standard deviation in the measurements.

Table 37 Volumetric rate (r_s), apparent removal efficiency η_s and absolute rate (R_s) of the reactor (100L) operated with a HRT (3 days). These values were estimated from the samples RR1 and EFF. Otherwise, the results can be analysed by comparing INF and EFF samples. Apart for the Max removal values (first column), the estimation for TCOD, SCOD and TSS are similar.

Parameters	r_s [mg L ⁻¹ d ⁻¹]	η_s [%]	R_s [g d ⁻¹]
Max	820±10	92±1	24.6±10
TCOD	276±22	53±11	8.3±22
SCOD	359±28	81±6	10.7±28
NH ₄ -N	-5.38±358	19±811	-0.16±358
TN _f	28.95±34	49±25	0.87±34
PO ₄	2.08±25	53±15	0.06±25
TSS	-54±87		1.6±87



Biomass, yield and TSS productivity

The estimation of the biomass can be assumed from the difference between $TCOD_{EFF}$ and $SCOD_{EFF}$. However, it must be considered somehow to be related to the presence of TSS in the influent ($247 \pm 24\%$ mg COD/L). If we assume this difference to be slowly biodegradable compounds, the minimum biomass concentration can be calculated as shown in Equation 2.

Equation 2 Equation to calculate the minimum biomass concentration

$$TCOD_{eff} - SCOD_{eff} - \Delta COD_{inf}$$

With this additional information, Table 38 summarises the total biomass concentration in the effluent. The estimation of the biomass then varies between 566 and 319 mg COD/L. The removed SCOD (INF-EFF) had an average of 1332 ± 11 mg COD/L.

Table 38 Total biomass concentration in the effluent; COD_b =COD biomass; COD_{rem} =COD removed

mg COD/L	mg COD_b /(mg COD_{rem})	g TSS/L		g COD/(g TSS)
$X_{b,max} 544 \pm 13$	$Y_{max} 0.48 \pm 13$	TSS 0.31 ± 7.78	COD/TSS	1.69 ± 11
$X_{b,min} 196 \pm 31$	$Y_{min} 0.30 \pm 8$	TSS 0.31 ± 7.78	COD/TSS	0.92 ± 20

The maximum and minimum yields are respectively 0.52 and 0.30 mg COD_b /(mg COD_{rem}). Over the observed week, the average TSS concentration was at an average of 0.31 g TSS/L, but with a large standard deviation. Thus, the fraction g COD_b /(g TSS) reaches 1.69 and 0.92 for the two estimations. According to literature, the standard value corresponding to this parameter is 1.42 g COD_b /(g VS); as, in this case, the volatile suspended solids/total suspended solids (VSS/TSS) fraction remains very close to unity, more than 95%. This last value will be considered as reference. With these assumptions the estimated biomass in the effluent is 440 mg COD/L. Thus, considering the reactor in stable condition the yield lays around 0.39 g COD_b /(g COD_s).

The COD:N:P balance of the reactor is calculated from the rs of the system and it is assessed at 100:8.0:0.5. With the estimated yield of 40%, the biomass composition should be close to 100:20:1.25 COD/N/P, though normal biomass compositions vary around an average of 100:5:1. If it is true that purple bacteria have a higher nitrogen fraction in their elemental composition (100:7:2), the nitrogen balance results still out of range. A possible explanation for this result is the hydrolysis reaction of urea which can produce as well NH_3 which is highly volatile. With an effluent of 30 L/d the TSS productivity was measured around 9.3 g TSS/d. However, biomass should be extracted from water to be used as a fertiliser. As a standard treatment step a simple sedimentation process is applied in wastewater treatment. To have an estimation of the settle ability of the biomass, supernatant was taken after a time period of 12h of the dark phase (RR3). From this analysis, it resulted that only 30% of the TSS settled, reducing the TSS to 3.2 g TSS/d.

Comparison between the reactor run with synthetic nutrients and urine as nutrient source

The reactor was first run with synthetic nutrient (phase1) under the same hydraulic conditions, compared with phase 2 when urine was used as nutrient source. Nevertheless, there were few differences. Nutrients were added with a solution of NH_4Cl and KH_2PO_4 prepared with tap water from the brewery with 6.24 g/L and 1.01 g/L, respectively. The



feeding and extraction cycle were considerably different (45 min instead of 15 min). Primarily this affected the peak of organic matter after the feeding. Another technical difference was the pH that was kept constant at 7.5 via CO₂ bottle sparging during the day cycle, whereas in the second phase there were two/three shot of acid addition. Finally, it is important to mention that because the influent batch wastewater was kept inside a building with a temperature of 20°C, the biological activity in the influent equalisation tank was almost three times higher than the previous case around 170 mg SCOD/(L*d) compared to the previous 67 mg SCOD/(L*d). For that reason, the influent batch was changed on average every three days. While comparing these results, it should be considered that these samples were filtered with a 0.45 µm membrane instead a 0.20 µm membrane. This can considerably affect the effluent concentration since it is known that purple bacteria, as other bacteria species, can have dimensions smaller the 0.45 µm, so they can pass through the membrane.

Table 39 regroups the apparent volumetric rate (r_s), the relative removal efficiency (η_s) and the removal rate (R_s) for the first phase. As in this case, the comparison between the relative and absolute removal efficiency are similar, so the reactor can be said under stable conditions. As said the different methods to filter the sample could explain the difference in the SCOD removal efficiency. Whereas, to explain the difference in the TCOD removal, the higher TSS concentration measured in the influent (0.2 g TSS/L vs 0.07 g TSS/L) might be a reasonable explanation. Around 610 mg COD/L of biomass is estimated with the related yield of 0.56 mg COD_b/(mg COD_{rem}), and a final productivity of 12.9 g TSS/d. In addition, the settleable solids in the reactor was measured around 231 mg COD/L, approximately the 35% of the total biomass as in the other raceway reactor. With these assumptions the COD:N:P ratio of the system is 100:5.7:1 which gives an estimation of the biomass of 100:10.17:1.75, which is in line with literature studies.

Table 39 Volumetric rate (r_s), apparent efficiency removal η_s , and absolute rate (R_s) of the reactor (100L) operated with a HRT (3 days). These values were estimated from the samples RR1 and EFF

Parameters	r_s [mg L ⁻¹ d ⁻¹]	η_s [%]	R_s [g d ⁻¹]
TCOD	268±21	39±11	8.04±22
SCOD	351±14	67±6	10.54±28
NH ₄ -N	20.94±20	58±9	0.60±20
PO ₄	3.63±36	51±23	0.11±36
TSS	-50±137		-1.53±216

In conclusion, the comparison between the two phases showed similar performances. Nonetheless, there were some relevant differences. First of all, the ammonia removal indicates that the system prefers synthetic ammonium than urine which was overdosed in the second phase. The diversion in the removal efficiency ($EFF_{th, max}$) can be justified by at least three factors: the two diverse filtering membrane to filter the samples, the higher organic loading rate in the first phase (0.482 – 0.635 g/(L*d) and a greater disturbance in the measurements due to a higher concentration of TSS in the influent (0.07 – 0.20 g TSS/L). The divergence of the biomass to substrate yield is difficult to assess, however all possible methods to estimate the biomass yield indicates a slightly higher removal efficiency in the first phase. This last factor is understandable as the reactor in phase two, was recovering from an upset. For both experiments, it would be interesting to analyse and assess the hydrolysis of TSS in the raceway reactor so that the disturbance of the influent TSS could be at least estimated. Lastly, the greater TSS productivity measured in the first phase is reasonable because of the higher OLR rate.



Verification Tests – Plant Trials

The obtained fertiliser was used in two different growing plant experiments. Initially the plant experiments were designed for a climate room (SEMILLA). Later in the project, GROWx (Vertical farm, Amsterdam) had a higher role in the concept as end user and business validation of the purple bacteria biomass. Therefore, the plant trials were planned to be run at the experimental facility of GROWx where the plant species and substrates can be used, therefore a more accurate application of the fertiliser.

The candidate plant was microgreens. Microgreens are young vegetable greens that are approximately 1–3 inches (2.5–7.5 cm) tall. They have an aromatic flavour and concentrated nutrient content and come in a variety of colours and textures. Microgreens are considered baby plants, falling somewhere between a sprout and baby green. That said, they shouldn't be confused with sprouts, which do not have leaves. Sprouts also have a much shorter growing cycle of 2–7 days, whereas microgreens are usually harvested 7–21 days after germination once the plant's first true leaves have emerged.

Besides the coco husk-based substrate, a cellulose substrate was also tested, as it is the substrate of choice in the operations at GROWx farm. For the rest of technical requirements referring to light, pH, temperature, the plant cells from GROWx as described below have the same characteristics as the plant chamber initially planned for the plant trials. The fertiliser rate application was calculated based on the analysis of the biomass harvested in the raceway reactor during the verification tests. The experiments were set for Lettuce, as candidate crop, but because of the COVID-19 affected timeline, it was decided to conclude the project through a more rapid test on microgreens.

Results and discussion

First Experiment

In the first trial there were a couple of operational failure due to the aim of matching the no flush irrigation system of the robot from GROWx. This led to a lack of irrigation during one of the weekends when half of the gutters dried, killing the plants. However, the rest of the plants could still be cultivated as planned to harvest time and the yield was calculated relative to the surface area so the data was relevant. The plants were also kept longer in germination and added synthetic nutrients after 15 days instead of 10, which imposed another experiment start-up to compare the results and follow-up a stricter protocol. Besides the measurements, there were also observational qualitative data gathered. It was observed that in general the plants grown on the jute substrate looked healthier and lusher compared with the plants grown on the cellulose substrate. GROWx uses generally the cellulose one. The plants where PNSB was applied looked better than those without PNSB with less yellow leaves, especially on the cellulose substrate. The plants that received synthetic fertiliser were larger but still yellow.

Second Experiment

In the second experiment, lessons learnt from the first trial went in designing the experiment and research protocol. As before, some general observations were made during the research. When the plants were moved in the experiment cell, it was already observable that the plants grown on the jute substrate look healthier than the ones on cellulose. This was observed during the whole experiment. In addition, the plants cultivated on cellulose substrate were becoming slightly yellow, 4 days before the additional nutrients. In this plant trial the ones



that received synthetic fertiliser showed a fast growth and the ones without being smaller and less developed. Even those that were inoculated with the purple bacteria. There were some yellow spots on the substrates with PNSB on the jute substrate, and generally the plants closer to the irrigation influent looked better than those closer to the drainage. This shows a not optimal saturation throughout the gutter.

In Table 40, it can be seen that the plants in the second experiment had an average better growth. In the first experiment it is clear that plants in the Jute substrate had a better growth. In the second experiment there were no significant differences between the two substrates, although the growers noticed many observable differences between the two types of substrates. Namely, plants growing on jute looked better, in general.

Table 40 Substrate influence on plant yield

Treatment	Experiment 1 [g m ⁻²]	Experiment 2 [g m ⁻²]
Cellulose substrate	560.36±50.03 ^a	876±98.50 ^b
Jute substrate	703.25±163.19 ^a	878.80±107.13 ^a

Looking at Table 41 the updated protocol for the second research resulted in more conclusive data. In the first experiment although there are small differences in the average growth (disregard of substrate type) there are no statistically significant differences.

Table 41 Fertiliser treatments applied to the microgreen and their influence on the yield

Treatment	Experiment 1 [g m ⁻²]	Experiment 2 [g m ⁻²]
Control (no nutrient)	634.57±151.03 ^a	739.44±44.76 ^c
PNSB	552.88±101.99 ^a	808.68±7.22 ^b
PNSB + nutrient	616.44±143.88 ^a	913.40±131.64 ^a
GrowX Nutrient	723.34±211.24 ^a	919.63±3.44 ^a

Moreover, in this trial, the plants that received the PNSb fertiliser had the worst growth, even less than the ones receiving no fertiliser. This also highlights the limitation of testing the fertiliser with micro-greens, as the plants have very limited demand for fertiliser. In experiment two it was observed that the plants that received no fertiliser have developed the worst, as expected. The plants that received solely PNSB as fertiliser had a significantly higher yield but still significantly lower than the plants that received the GROWx synthetic nutrients. Interestingly, the plants that received PNSB and the missing nutrients (potassium) have performed as good as the ones that received the full synthetic nutrient solution. These results show that the PNSB could be a valid fertiliser but used alone, without the complementing elements will perform poorer than the traditional synthetic fertiliser. The sub-optimal plant cells used in the experiment impacted the growth of the plants significantly. A normal yield obtained in the cultivation chambers at GROWx is around two-fold higher than what was obtained by the full GROWx nutrient solution in the cells. This shows that the plants reacted to the low humidity, improper irrigation, and temperature and not just nutrients. The experiment still shows the potential of the purple bacteria as fertiliser as the negative and positive control were in the same conditions, but a more thoroughly trial will be run in more efficient cultivation chambers. The nutrient use of the plants in optimal conditions will render most significant results.



In the next experiments we will investigate concentrated live cell biomass in hydroponics. A study showed that full mineralisation of nitrogen happened after 70 days from inoculation (Simate 2011). With cultivation of microgreens less than 30 days, the mineralization might have not been complete, therefore the full potential of the biomass not explored. Experiments with higher plants (lettuce) would be more conclusive. The use of the bacteria as fertiliser needs to be integrated in the business case. The slightly lower yield obtained by the solely use of the bacteria could still make a good business case, as costs with synthetic nutrients are lowered. Moreover, the products could be labelled organic by using only the bacteria fertiliser. On the other hand, the use of the PNSB as fertiliser and including missing fertiliser could help obtaining the yield comparable with the use of full synthetic fertiliser. Therefore, the nutrients recovered from waste streams would lower costs and increase the CO₂ of the organisation.

Nitrogen mineralisation rates

The nitrogen mineralisation was analysed to see the impact of the substrate in converting the ammonia to nitrate which is the preferred nitrogen source for plant cultivation. In previous research projects it was assessed that full nutrient mineralisation was obtained after 70 days from inoculation (Simate et al. 2011). In this case the inoculation was with 240 mg N/L and the inoculation was done in a growing medium with sufficient dosage of phosphorus and potassium. The soil-based substrate used will improve mineralisation, but it is not recommended in vertical farming practices. The contamination and pest control are more challenging in soil-based system in controlled environment. In the research presented here, the inoculation was done on organic substrates (cellulose and coco husk based) used for microgreens. These types of substrates are characteristically very thin to allow for the formation of the roots of the plants and stack them vertically in the farm. Therefore, the total volume to surface area is very low, compared with conventional cultivation in pots, bags or other systems. Due to the biomass availability, mineralisation rate was only investigated with the plants cultivation. Repeating the experiment without the plants will show a clear distinction of ammonification to nitrate, without taking in account the nitrogen lost in the plant cultivation. In Figure 39, the expected trends of NH₄ and NO₃ are shown.

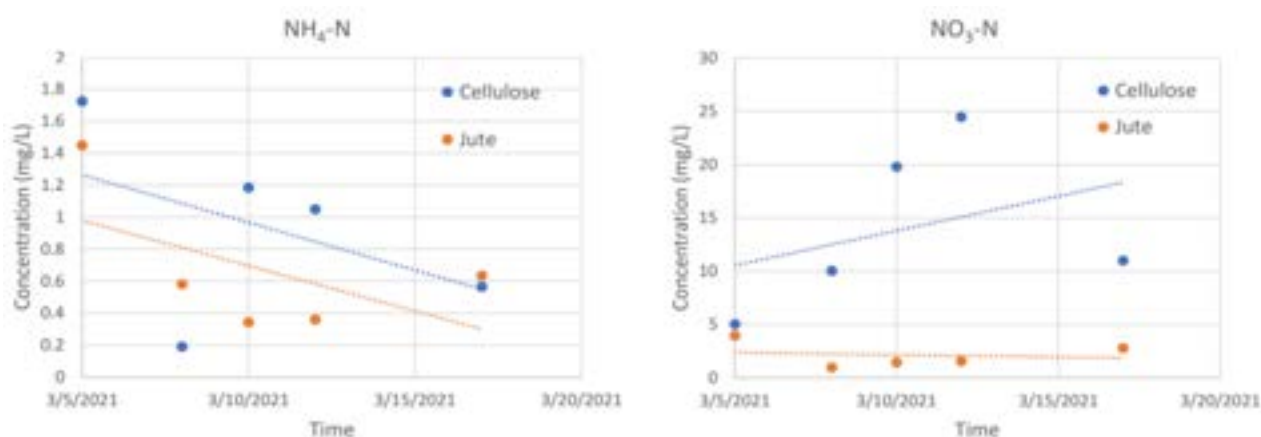

Figure 39 Expected trends of NH₄ and NO₃

The ammonia is steadily decreasing in both substrates from the first day of the cultivation to harvest. In around 15 days of cultivation, 60 to 70% mineralisation was obtained. In practice, GROWx adds nutrients after day 10, when the plants request it. At this point the nitrogen was roughly 40% mineralised, therefore the substrate preparation needs to be done in advance of the sowing to reach maximal mineralisation at the peak of cultivation. With respect to the



nitrate trend, there were significant differences between the plants cultivated on cellulose and jute. It was observed that the plants in the jute substrate had a general better growth and looked generally healthier. The nitrate doesn't show the expected upwards trend, that could be also explained by the better nutrient uptake in the plants during the vegetation. In the cellulose substrate the nitrate is steadily increased. It is important to mention here that the samples were taken regularly every second to third day from the effluent. The degradation rate for the biomass and releasing the nutrients in the substrate needs to be better investigated. In a flush system, the nutrients that are not taken by the plants are flushed away. In the future experiments the procedure will be done in closed cycle where the total nutrient efficiency will be monitored as well as the mineralisation in different substrates, with and without plants. It is expected that living cells will have a more rapid degradation in the nutrient solution and it will be investigated what is the optimal application rate to reach the demand of plants without nutrient flushing or nutrient build up. Heavy metals and contamination the fresh harvested biomass was sent to an external lab for full heavy metal analysis. The European Food Safety Authority imposes limits on heavy metals to food stuff for Cadmium (Cd), Lead (Pb) for leafy greens and Mercury (Hg) and Tin (Sn) for other food items.

Hazard analysis and critical control point for ready to use food

When it comes to food safety, EFSA imposes a hazard analysis and critical control points approach in the whole food chain. In the case of ready to eat food and specifically the type of leafy greens cultivated in this project, the fresh biomass was sent to an external lab where the microbiological contamination was assessed. The results showed that for all parameters followed by EFSA for the leafy greens, the data were always below the limits (Table 42, Table 43).

Table 42 Hazard Analysis Critical Control Point for ready to use food in the experiments 1 and 2 for the plants inoculated with the purple bacteria, versus the plants grown with synthetic, according with the EFSA regulations

Parameter	Result			EFSA Limits [5]
	Exp. 1 PNSB	Exp. 2 PNSB	Exp. 2 no-PNSB	
Aerobic colony count bacteria	>3*10 ⁶	>3*10 ⁵	3*10 ⁵	na [CFU g ⁻¹]
Enterobacteriaceae	>10 ⁵	38*10 ³	48*10 ³	na [CFU g ⁻¹]
Coliforms	>15*10 ⁴	2*10 ³	24*10 ³	na [CFU g ⁻¹]
Salmonella	na	na	na	Absence in 25 g
E. coli	<10	<10	<10	<10 ⁵ [CFU g ⁻¹]
Listeria monocytogenes	na	na	na	Absence in 25 g
Staphylococcus monocytogenes	< 10 ³	<10 ³	<10 ³	<10 ⁴ [CFU g ⁻¹]
Bacillus cereus	<10 ²	29*10 ²	58*10 ²	<10 ⁵ [CFU g ⁻¹]
Fungi, Yeasts	>15*10 ⁴	<10	<10	na [CFU g ⁻¹]
STEC, EHEC	na	na	na	Absence in 25 g

Table 43 Heavy metal content in microgreen harvested in both experiments in different substrates (C-cellulose and J-jute) with and without PNSB

Parameter	Result [mg kg ⁻¹ DM]					EFSA Limits [4] [mg kg ⁻¹ DM]
	E1 PNSB	E2 - J PNSB	E2 - C PNSB	E2 -J no-PNSB	E2 - C no-PNSB	
Al	12.4	2.4	1.5	1.5	1.2	na
Ag	0.16	0.057	0.049	0.049	0.036	na
As	0.049	0.029	<0.02	<0.02	<0.02	na
Ba	22.3	22.8	18.3	15.6	13.1	na
Cd	0.10	0.069	0.031	0.050	0.020	<0.20
Co	<0.05	<0.05	<0.05	<0.05	<0.05	na
Hg	<0.01	0.013	0.011	<0.01	<0.01	na
Cr	0.16	0.091	0.075	0.051	0.062	na
Cu	8.6	6.2	7.2	5.1	5.5	na
Ni	0.50	0.38	0.38	0.28	0.31	na
Pb	0.064	0.014	0.013	<0.01	<0.01	<0.30
Sn	0.30	0.30	0.25	0.18	0.19	na
Zn	571	662	623	335	268	na



Showing that the plants cultivated with the PNSB are safe to be consumed by humans. An observation is important to be made at this point. The urine was collected from a single person, the operator of the system, due to the pandemic that made urine from other projects not available. A bigger urine sample and more diverse would be needed to fully conclude the safety of the bacteria use. Another point that was not in the scope of the project and deserves a separate dedicated work is the antibiotics that could be found in the biomass obtained on municipal streams. There are technologies to mitigate that, but more research needs to be done in order to get the EFSA regulations for food safety.

3.8 Comparison of the baseline situation and the NextGen KPIs

The photobioreactor showed a good performance in terms of the fertiliser potential of the purple bacteria. An overview of the reactor performance is reported below. The COD removal rate was equal to 466 mg COD/(L*d), the biomass concentration in the effluent was estimated around 799 mg COD/L and the measured yield resulted 0.38 mg COD_b/(mg COD_s) (Table 44). The total COD removal efficiency was estimated nearly at 80% and around 50% for nitrogen and phosphorus. The nitrogen and phosphorus uptake was measured respectively around 20 mgN/L/d and 3.63 mgP/L/d. Therefore the system COD:N:P resulted in 100:4.5:0.78. Considering biomass composition as 100:7:2 and focusing the balance on the removal and assimilation of phosphate, the measured yield is 0.38 mg COD_b/(mg COD_s), in line with what reported in Table 44.

Table 44 KPIs for protein production in La Trappe

Objectives	KPI	Result
Successful operation of photo bioreactor turning brewery water and urine into bio stimulant	Effluent biomass	799 mg COD/L ± 23%
	COD Removal rate	466 mg COD/(L*d) ± 21%
	COD Removal efficiency	80%
	Substrate to biomass yield (= COD recovery rate)	0.38 mg COD _b /(mg COD _s) ± 22% (=38%)
	Nitrogen removal rate	20.9 mg/(L*d) ±21%
	Nitrogen removal efficiency	50%
	Nitrogen recovery rate	20%
	Phosphorus removal rate	3.63 mg/(L*d) ± 36%
	Phosphorus removal efficiency	50%
Phosphorus recovery rate	25%	

The pond design, as used for the experiments described above, was, however, not suitable for large scale production at the La Trappe site. This is due to the large surface area required, which is not available at the site. An alternative, advanced, reactor was designed by students from TU Delft (Figure 40). Due to many complications, tests with the more advanced reactor concept with multiple IR illuminated baffles could not be performed. The next stage would be either to cultivate the purple bacteria as a main product without focusing on water treatment or to consider a simulation regarding the use of multiple illumination baffles to move to the next TRL level.



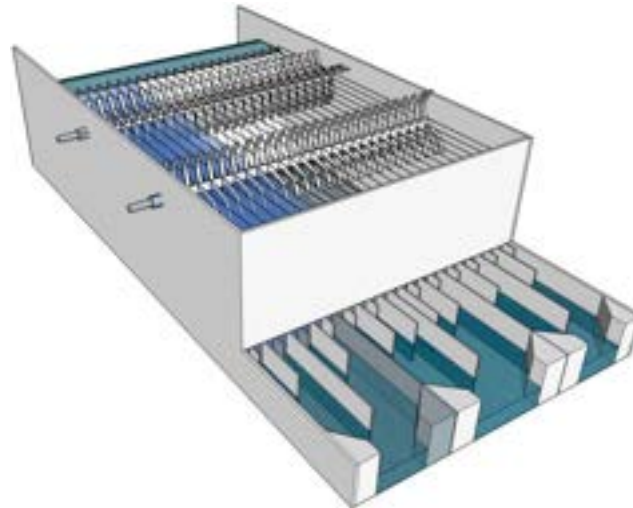

Figure 40 Advanced reactor proposed by TU Delft students

3.9 Lessons learned

At the La Trappe site, three different technologies, i.e. Metabolic Network Reactor, MELISSA inspired membrane systems and MELISSA inspired photobioreactor, were implemented, that are interconnected. The interaction of the single technical units is complex and has to be considered in the system design. The system design, the installation, system control and automation of the technological units did not work well and all units had to be operated separately.

In this section, the lessons learned from the photobioreactor are presented.

Required competence	
<p>A training is needed to provide the knowledge that is needed and does not belong to the classical wastewater treatment knowledge of a WWTP operator in the Netherlands such as:</p> <ul style="list-style-type: none"> • Photobioreactor and competition with heterotrophic bacteria <p>The process is relatively easy to control and returns to nominal operating conditions with increased levels of purple bacteria a few days after upsets in loading rates. However, the technology is still at a too low TRL level to be considered for full scale operation at the La Trappe site.</p>	
Maintenance	
<p>Pond systems are normally low in maintenance. However, the more advanced hybrid photobioreactor could not be tested and hence, reliable data therefore are missing.</p>	
Technological risks	
<p>The technological risk depends mainly on the chemical composition of the feed stream. However, although purple bacteria can be harvested, the water quality produced is a cause of concern if the target is on water treatment. Subsequent post treatment is thus needed.</p>	

3.10 Best practice guideline to design and operate the technology

Important aspects to consider during the design and construction of the plant:

- Suitable materials must be used for the system (corrosion resistant, etc.)
- Compliance with the country specific requirements for health and safety
- Take weather conditions into account from start to avoid large surface area
- Recommendation: pre-experiments should be conducted to investigate, to what extent the microbial community can recover from upsets
- Design as side stream /pre-treatment for value added products, but avoid effluent quality dependence on photobioreactor.

Important aspects to consider during the start-up of the plant:

- The process water must be as free as possible of particles.
- The chemical composition of the process water should be as constant as possible and the flow rate should be sufficient high to run the process properly.
- Compliance with the country specific requirements for health and safety
- Sampling plan should be considered and the sampling documented.
- Functioning test for electricity and mechanics should be done.
- Leakage test should be done.

Crucial parameters for the optimisation of the production process:

- Chemical composition of the process water (organic matter/COD, phosphate and ammonium concentrations, TSS) (Table 45),
- Temperature and pH

Table 45 *Crucial operating parameters for the photobioreactor: ranges for the best results*

Parameter	Units	Min	Max
C/N ratio		14:1	
TSS feed	mg/L	as low as possible, raw effluent was fine	
pH/T photobioreactor	-/°C	6.5/25	7.5/30



4. Nitrogen removal and recovery

Three case studies deal with nitrogen removal and recovery. In Braunschweig and Altenrhein ammonium sulphate solutions is produced via air stripping and scrubbing as well as via membrane stripping, respectively. In Sernal, solid ammonium sulphate is produced using an ion exchanger to concentrate ammonium and membrane stripping to produce the secondary fertiliser.

4.1 Ammonium sulphate production via air stripping and scrubbing in Braunschweig (GER)

Authors: Anne Kleyböcker (KWB) and Janina Heinze (AVB)

4.1.1 Description of the demo site

The wastewater treatment plant Steinhof, near Braunschweig, has a long tradition of water and nutrient reuse. Already at the end of the 19th century, fields were irrigated with sewage. From 1954 on, the wastewater was mechanically clarified and reused for irrigation. Finally, in 1979, the wastewater treatment plant (WWTP) was built and comprised a conventional activated sludge treatment system and a digestion stage. Until 2016, in summer, the digestate was directly reused in agriculture, while in winter, the digestate was dewatered and stored until the summer season. However, due to the new legislation in Germany, since 2017 only 60% of the digestate can be applied on the fields. The reasons are restricted periods for fertilising with digested sewage sludge and the limitation of the nitrogen load to the agricultural fields. Thus, the other 40% of the digestate were dewatered and incinerated.

In 2019, a new circular economy concept was implemented. Here, energy recovery technologies are combined with nutrient recovery technologies. Therefore, the sludge management concept was adapted to increase the nutrient recovery rate and simultaneously, as a synergetic effect, the biogas recovery rate increased. Hence, circular economy solution comprises a thermal hydrolysis process between two digestion stages and a full-scale nutrient recovery plant consisting of a struvite production unit to recover phosphorus and an ammonium sulphate solution production unit to recover nitrogen.

The secondary fertilisers will be reused by the local farmers and the produced energy in the form of biogas and heat is reused by the plant itself.

4.1.2 Motivation of implementing circular economy solutions in the water sector

The original WWTP was designed for 275 000 population equivalents. However, the actual load refers to 380 000 population equivalents. In order to guarantee a clean effluent of the WWTP complying with legal thresholds, a circular economy approach was implemented not only to remove nutrients from the wastewater, but also to recover them in combination with an enhanced energy recovery system. In detail, phosphorus and nitrogen are recovered via the production of struvite and ammonium sulphate and the biogas production rate is enhanced due to a thermal pressure hydrolysis.



Benefits of an ammonium sulphate production unit via air stripping and gas scrubbing:

- ✓ Robust process

In contrast to the microbial nitrogen removal via nitrification and denitrification, the nitrogen removal via stripping and scrubbing does not rely on microorganisms and thus, the process is very robust.

- ✓ Reduction of formation of N₂O in the activated sludge process of the WWTP

Reducing the nitrogen return load to the mainline will stabilize the nitrogen removal and helps to prevent overloads of the treatment capacity. As high nitrogen loads and high fluctuations often lead to higher emissions of N₂O from the activated sludge process, air stripping will also lead to a decrease in emissions of this potent greenhouse gas.

4.1.3 Actions and case study objectives

Table 46 Action and case study objective in Braunschweig regarding ammonia recovery

Case Study & Subtask	Technology baseline	NextGen intervention in circular economy for water sector	TRL	Capacity	Quantifiable target
#1 Braunschweig, Germany Sub-task 1.4.7	Irrigation and fertilisation of agricultural fields with WWTP effluent and digestate	Ammonia stripping & scrubbing to produce ammonium sulphate solution	TRL 9	Around 2000 t/a ammonium sulphate solution (wet) corresponding to 175 t N/a	Ammonium sulphate solution production: ≥85% recovery from N load to recovery unit

4.1.4 Unique selling points

Unique selling points for the production of ammonium sulphate via air stripping and gas scrubbing are:

- ✓ High ammonia recovery rates related to the ammonium influent to the recovery unit between 85% and 97%
- ✓ Market-ready product: ammonium sulphate solution as a liquid fertiliser
- ✓ Mature technology and robust process
- ✓ Reduction of N₂O emissions vis reduction of nitrogen return load

4.1.5 Principal and main characteristics of the technology

In the case study Braunschweig, three different technologies were implemented that are interconnected with each other:

- thermal pressure hydrolysis,
- struvite production and
- ammonium sulphate solution production via air stripping and gas scrubbing.

This chapter focuses on the ammonium sulphate production plant.



Nitrogen is one of the main nutrients contained in wastewater. In wastewater treatment, nitrogen is usually removed biologically via nitrification and denitrification. There, the nitrogen is emitted into the air. The process described here relies on chemical reactions and offers the opportunity to recover the nitrogen in the form of ammonium sulphate solution. The process is usually applied in sludge liquor that is rich in ammonium and at wastewater treatment plants with a capacity of 100 000 population equivalents and greater.

In order to produce ammonium sulphate solution, two columns are used in sequence (Figure 41). The first column is the ammonia stripping unit (Figure 42). Here, the ammonium rich liquor is stripped with air at a temperature between 55 °C and 65 °C and at a pH between 9 and 11.

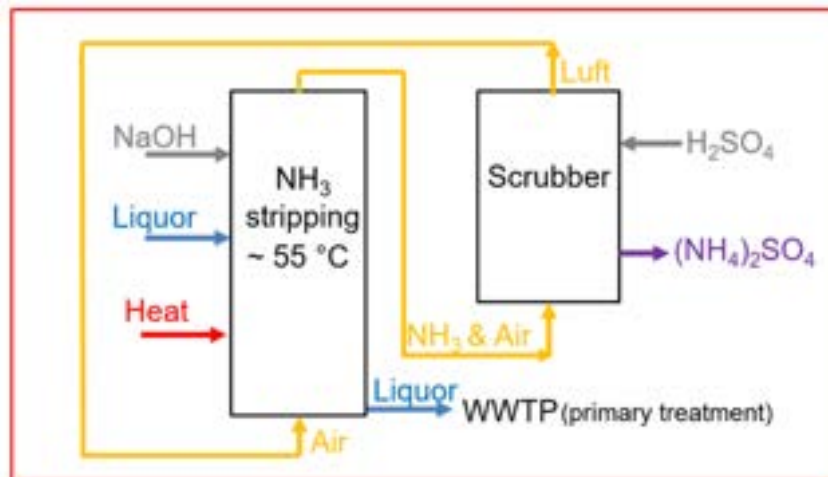

Figure 41 Flow scheme of the ammonium sulphate production unit

Ammonium and ammonia depend on each other and their equilibrium depends on pH and temperature. The higher the temperature is and the higher the pH is, the more the equilibrium between ammonium and ammonia shifts to the ammonia side. In order to increase the pH to alkaline conditions, carbon dioxide is stripped from the liquor and sodium hydroxide is added. Under those conditions, ammonium reacts to ammonia and can be stripped out via air stripping. In a subsequent gas scrubber, that is the second column, the obtained ammonia gas reacts with sulphuric acid to ammonium sulphate. Hereby, the ammonia free air can be reused and is injected in the air stripper again. The relation of the air flow compared to the liquor flow is around 500.



Figure 42 Pictures of the ammonium sulphate production units, the storage tank and an ammonium sulphate solution sample

Ammonium sulphate solution is a nitrogen fertiliser. Typical concentrations are 37 – 40% of ammonium sulphate in water. According to Szymańska et al. 2019, the reference fertiliser efficiency describes the effectiveness of the ammonium sulphate produced by such a system compared to that of commercially available ammonium sulphate. Both are in a similar range, the reference fertiliser efficiency of the ammonium sulphate solution is between 89 and 103% of that for commercial ammonium sulphate depending on the plant and soil type.

4.1.6 Requirements for the implementation of the technology and operating conditions

In order to reach high ammonia yields, the fraction of ammonium in relation to the total nitrogen content should be as high as possible. Up to now, the process was applied for concentrations between 700 and 4000 mg NH₄-N/L. However, technically a lower concentration is also feasible. In this case, it should be investigated, if the process can be still operated economically rewarding. Anaerobic digestion combined with an additional thermal pressure hydrolysis can help to lyse and degrade organic compounds resulting in an increase in ammonium concentrations.

Table 47 Requirements and operating conditions for ammonium sulphate solution production

Parameter	Units	Min	Max	Reference
NH ₄ -N feed	mg/L	700	4000	Böhler et al. 2012, Heinze (2022)
TSS feed	mg/L	-	600	Heinze (2022)
pH	-	9.5	11	Heinze (2022)
Temperature	°C	55	65	Heinze (2022)

4.1.7 Results: Ammonium sulphate production via air stripping and gas scrubbing

In 2019, the ammonium sulphate production unit was implemented. As shown in Figure 43, the process is running since almost 1000 days with periods of downtimes due to the optimisation demand of the struvite production process. However, during the periods of operation, the nitrogen recovery rates with respect to TKN ranged mainly between 88% and 97% in the expected range above 85%. Two optimal operating conditions were identified for pH 11 with a temperature at 55 °C and for pH 9.5 with a temperature at 65 °C.

Due to the lower pH of 9.5 compared to a pH of 11, around 30% of sodium hydroxide was saved. However, due to the higher temperature of 65 °C compared to 55 °C, the heat demand increased. Because excess heat from the combined heat and power plant is available, the operating condition with the lower pH is beneficial for Braunschweig.

A further decrease in the temperature below 55° C and down to 50°C at the pH of 9.5 resulted in a recovery rate of 79% around day 900 that was considered as too low. Therefore, if a recovery rate of 85% and higher is required, the temperature should be maintained at 55 °C for a pH at 9.5.



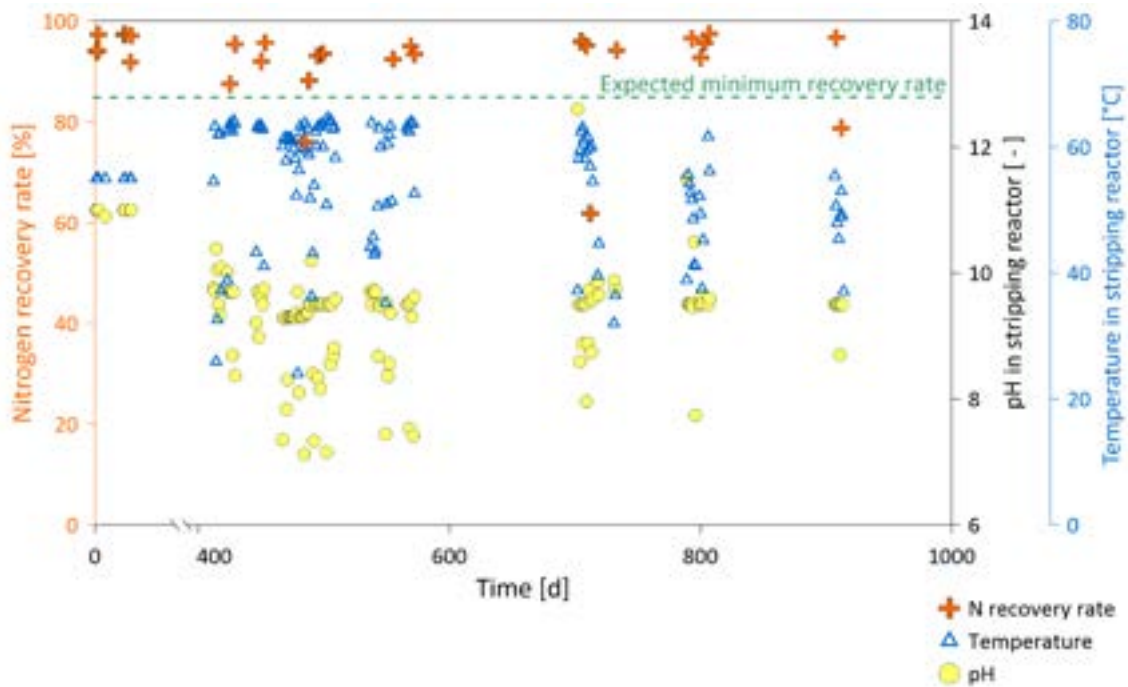

Figure 43 Nitrogen recovery rates reach their expected range at 85% and higher with different operating conditions in pH and temperature

The chemical composition of the ammonium sulphate solution is shown in Figure 44. The nitrogen content is around 9% and complies with the German fertiliser ordinance (DüMV 2012) which requires a content above 5%.

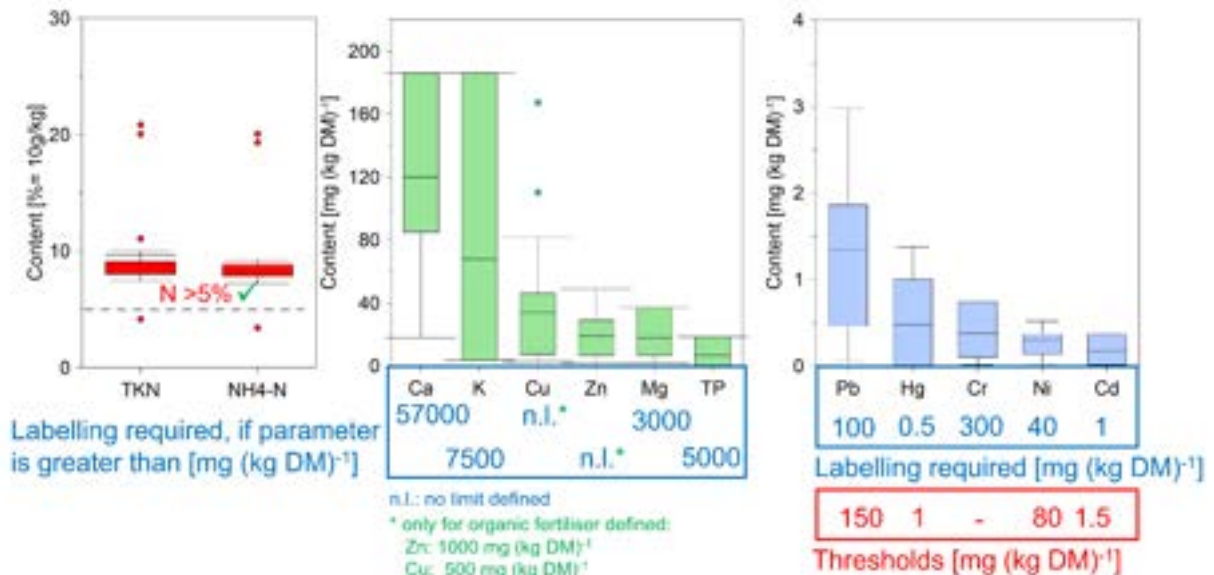

Figure 44 Chemical composition of the ammonium sulphate solution (n= 20 samples) compared to the legal requirements of the German fertiliser regulation (DüMV 2012): Hg is critical, but the other parameters are far below the legal thresholds

Correspondingly, the sulphur content is around 10% and hence above 6% as required by the German regulation (DüMV 2012). For Ca, K, Mg, TP, Pb, Cr, Ni and Cd, their contents are below their defined thresholds and below the limit value, for which they have to be labelled. For Cu and Zn, the German fertiliser regulation (DüMV 2012) does not provide any values as



thresholds or for labelling. However, the regulation provides values for organic fertilisers in terms of Cu and Zn. For a rough estimation, those values are used for comparison. The actual contents are on average a factor 10 and a factor 50 below the limit for labelling indicating a good quality. However, for Hg, its content is for every fourth sample above its legal threshold and for every second sample very close to the limit value for labelling. Hence, for Hg the ammonium sulphate solution does not always comply with the German fertiliser regulation (DüMV 2012).

In order to investigate, what the source for the Hg contamination is, the concentration of Hg was measured in the effluent from the struvite production unit that is equal to the influent to the ammonia stripping unit (Figure 45).

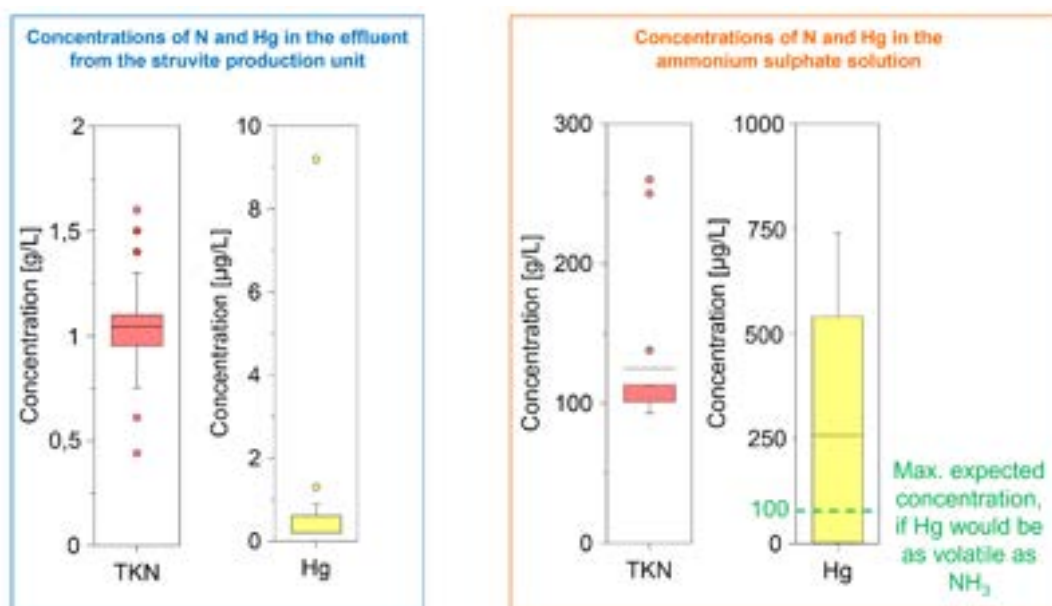

Figure 45 Concentrations of N and Hg in the effluent from the struvite production unit compared to the concentrations in the ammonium sulphate solution units.

The Hg concentration in the influent stream to the stripper is mainly below 1 µg/L. According to Heidelberg et al. 2014, the gaseous emission of Hg in its elemental form is enhanced via aeration and alkalisiation at a temperature of 60 °C. Those conditions are met in the air stripping unit with a pH at around 9.5 and a temperature of 65° C. Assuming, that Hg is as volatile as NH₃, the maximum expected concentration of Hg in the ammonium sulphate concentration is estimated by the same concentration factor as for the nitrogen (TKN). It should be noted that Heidelberg et al. 2014 observed a gaseous emission rate of only 35%, what is much lower than that assumed here with 85-97% referring to the nitrogen recovery rate. Hence, in this worst case scenario, the expected concentration of Hg would be equal to 1 µg/L * 100 = 100 µg/L. Due to the actual concentration in the ammonium sulphate solution which is a factor of 7.5 higher than the expected one, the Hg contamination must have another origin. This suggests the sulphuric acid to be the potential source for the contamination with Hg. Therefore, an analysis of the sulphuric acid will be conducted in the near future.

In the Fertilising Products Regulation (EC 2019/1009), ammonium sulphate recovered from sewage sludge and/or wastewater is not explicitly considered until now. Because the ammonium sulphate solution will be used in Germany, the focus in NextGen was on the compliance with the German fertiliser regulation.

4.1.8 Comparison of the baseline situation and the NextGen KPIs

Before the implementation of the ammonium sulphate production unit, nitrogen was eliminated only via nitrification and denitrification in the WWTP in Braunschweig. The effluent concentration of total nitrogen was on average 12 mg/L, what is very close to the legally required 13 mg/L by the German wastewater directive (AbwV 2022). However, for Braunschweig, the local authority defined even a stricter nitrogen concentration in the effluent of 12 mg/L.

Due to the implementation of the ammonium sulphate production unit, the nitrogen return load to the WWTP significantly decreased and thus, the resulting nitrogen concentration in the effluent also decreased to 9.3 mg/L on average (Table 48). Hence, the requirements of the German wastewater directive and local authority are fulfilled. The results in terms of the ammonium sulphate production process and the ammonium sulphate quality are outlined and discussed in detail in chapter 4.1.7.

Table 48 Crucial parameters to evaluate the nitrogen related processes after implementation of the NextGen technologies

Parameter		Units	Mean	Standard deviation	Number of measurements	Comments
Wastewater to the WWTP	Flowrate	m ³ /a	18.665.400	242.009	yearly average values of three years	2019-2021
	Effluent from WWTP	Flowrate	m ³ /a	17.784.307		
Solids from WWTP to field	Massflow	t/a	2365	633	yearly average values of two years	2020-2021
Solids from WWTP to incineration	Massflow	t/a	1549	250		
Ammonium sulphate solution production	Production rate	t/a	2000	Optimisation of the processes is ongoing: estimated flowrate after optimisation phase of the nutrient recovery plant; actual recovery rate: 30% of expected rate		
Wastewater to the WWTP	TP	mg P /l	13.9	3	continuously measured	2021
	TKN	mg N /l	89	10		
	TSS	mg/L	439	125		
	COD _{hom}	mg/L	1009	151		
	COD _{filt}	mg/L	420	34		
Effluent from WWTP	TP	mg P /l	0.6	0.5		
	TKN	mg N /l	9.3	4		
	TSS	mg/L	7.2	5		
	COD _{hom}	mg/L	43	8		
	COD _{filt}	mg/L	37	5		
Ammonium sulfate solution	TN	g N /l	125	52	20	
	TP	mg P /l	3.6	4.75		

As already explained for the phosphorus, also the nitrogen was partly reused in agriculture through the application of the digestate on the fields and the irrigation with the effluent of WWTP. Now, to the additional recovery of ammonia from the liquor of dewatered digestate, 2000 t ammonium sulphate solution is expected to be recovered (Table 48). Thus, as soon as the nutrient recovery plants will be operated during an entire year under optimised conditions, 175 t N/year will be recovered via ammonium sulphate production and 17 t N/year will be recovered via struvite production in addition. This corresponds to 13% of the influent load to the WWTP.



In Braunschweig, high nitrogen recovery rates between 85 and 97% were reached for two different conditions: pH 11 at a temperature of 55 °C and pH 9.5 at a temperature of 65 °C as shown in chapter 4.1.7. This was also observed in six other studies summarised by Sengupta et al. (2015). They report about nitrogen recovery rates between 80 and 97% at pH conditions between 8 and 11 and at temperatures at 50°C, 75°C and 80°C. The higher the temperatures were and/or the higher the pH was, the higher the recovery rates were. Hence, a higher process temperature allows the process to be operated at a lower pH in order to save chemicals. This was also shown in Braunschweig. The increase from 55°C to 65 °C allowed the decrease in pH from 11 to 9.5 maintaining the expected recovery rate above 85% at both conditions. Hence, 30% of NaOH was saved due to the process temperature increase.

As already shown and discussed in chapter 4.1.7, the quality of the ammonium sulphate solution highly depends on the quality of the sulphuric acid. In the case of the ammonium sulphate produced in Braunschweig, the increased mercury concentration obviously resulted from the sulphuric acid. For the other pollutants, the legal thresholds were far above the measured concentrations indicating a high quality of the produced fertiliser. Table 49 shows the corresponding average values and standard deviations for the quality parameters referring to the ammonium sulphate solution and not to its dry matter content as in chapter 4.1.7.

Table 49 Quality parameters of the ammonium sulphate solution



Parameter	Units	Mean	Standard deviation	Number of measurements	Comments	
Ammonium sulphate solution	TKN	g/L	125	52	20	2021
	Ca	mg/L	65	28		
	Mg		10	8		
	K		37	47		
	Pb	µg/L	722	447		
	Cd		93	97		
	Cr		203	156		
	Cu	mg/L	18	21		
	Ni	µg/L	163	76		
	Zn	mg/L	10	8		
	Hg	µg/L	258	281		

4.1.9 Lessons learned

At the case study in Braunschweig, three different technologies were implemented, that are interconnected. The interaction of the single technical units is complex and has to be considered in the system design. The system design, the installation, system control and automation of the technological units worked well and only minimal optimisation was necessary.

However, as with many other innovative processes, numerous unexpected problems occurred, some of them were or are very time-consuming to deal with. Therefore, it is important to have employees who are open to new processes and that technology suppliers are available for a longer time period even after the commissioning of the system. In particular for the ammonium sulphate production unit, the lessons learned are presented in this section.



Required competence	
<p>A comprehensive training is needed to provide the knowledge that is needed and does not belong to the classical wastewater treatment knowledge of a WWTP operator in Germany such as:</p> <ul style="list-style-type: none"> • Ammonia air stripping • Ammonia gas scrubbing in sulphuric acid • Handling of hazardous substances (H₂SO₄ 96%, NaOH 50%, HCl 31%) <p>However, the process is easy to control, so that the recovery rate can be adjusted as required. Due to the technology maturity, challenges during operation are rare compared to the thermal pressure hydrolysis or the struvite production unit.</p>	
Maintenance	
<p>The ammonium sulphate production unit is a mature and robust technology. It can be easily switched on and off and is a low maintenance technology, if the requirements such as a particle-free feed stream are fulfilled. In the case of the occurrence of scaling on the heat exchangers and/or on the packing, the maintenance work of the plant becomes challenging.</p> <p>However, in the case this technology depends on a pre-treatment such as the recovery of struvite, downtimes of the pre-treatment will also cause downtimes of this technology.</p>	
Technological risks	
<p>The technological risk depends mainly on the chemical composition of the feed stream. For the ammonia recovery unit, the feed stream must be free of particles. In the case, the feed stream is prone to precipitation of certain minerals such as calcite or struvite, a pretreatment is required to avoid precipitation in the ammonia recovery unit. In Braunschweig for example, a struvite precipitation unit was implemented upstream of ammonia recovery unit. In the case, the struvite precipitation unit does not retain the struvite crystals completely, there is a risk of clogging or scaling, too.</p> <p>The product quality of the ammonium sulphate solutions highly depends on the quality of the sulphuric acid. Therefore, its quality should be considered and controlled, before it is applied in the gas scrubber.</p>	

4.1.10 Best practice guideline to design and operate the technology

Important aspects to consider during the design and construction of the plant:

- Suitable materials must be used for the system (corrosion resistant, etc.)
- Compliance with the country specific requirements for health and safety regarding the operation of the process (handling of chemicals, etc.)



- System should be flexible and adjustable (also accessible for retrofitting work)
- Enabling heat recovery contributes to a lower CO₂ footprint of the process
- Using as much excess heat as possible to enable the operation of the process at a higher temperature in order to run the process at a lower pH allowing to save NaOH
- Recommendation: pre-experiments should be conducted to investigate, whether undesired precipitation processes might occur in the stripping unit, heat exchangers, etc.

Important aspects to consider during the start-up of the plant:

- The process water must be as free as possible of particles.
- The chemical composition of the process water should be as constant as possible and the flow rate should be sufficient high to run the process properly.
- Compliance with the country specific requirements for health and safety
- Sampling plan should be considered and the sampling documented.
- Functioning test for electricity and mechanics should be done.
- Leakage test should be done.

Crucial parameters for the optimisation of the production process:

- Chemical composition of the process water (phosphate and ammonium concentrations, TSS) (Table 50),
- Chemical composition of sulphuric acid (possible contamination should be checked such as Hg content)
- To control the ammonia recovery rate, temperature and pH are the crucial parameters. As shown in chapter 4.1.7, the best results were obtained at a temperature between 55 °C and at a pH of 9.5.

Table 50 Crucial operating parameters for the ammonium sulphate production process: ranges for the best results

Parameter	Units	Min	Max
NH ₄ -N feed	mg/L	>700	
TSS feed	mg/L	<600	
pH/T in stripping unit	-/°C	9.5/55	



4.2 Ammonium sulphate production via membrane stripping in Altenrhein (CH)

Authors: Anders Nättorp (FHNW), Christoph Egli (AVA)

4.2.1 Description of the demo site

The WWTP of Altenrhein provides residential drainage-, wastewater- and sludge treatment of 17 municipalities in two federal states (St. Gallen and Appenzell-Ausserrhoden).

The treated water reaches Lake Constance via the mouth of the Old Rhine. Both Lake Constance and the Old Rhine are considered priority water bodies for protection. Lake Constance also serves as a drinking water reservoir. The topographical conditions around these 17 municipalities vary greatly which makes the water transportation more challenging. For this reason, special structures are required.

Sludge that is being treated in Altenrhein originates from their own water treatment and is also being transported to the site by other WWTP of Eastern Switzerland. The WWTP of Altenrhein (AVA) has advanced energy-efficient sludge management technologies for 300.000 PE of sludge: sludge is dried on site and is co-incinerated in cement works. The heat for sludge drying is generated by burning of sewage gas and by heat recovery from wastewater using heat pumps.

AVA took a full-scale removal of micropollutants by ozonation and active carbon adsorption into operation in 2019 and an ammonia membrane stripping unit from sludge dewatering employing an innovative membrane contactor with a novel low fouling membrane module in 2021. This represents a total investment of EUR 20 Mio in innovative technologies.

4.2.2 Motivation of implementing circular economy solutions in the water sector

After the project AVA will have a clear idea of the technical and financial feasibility of on-site activated carbon regeneration and production of fresh activated carbon using locally available sludge and biomass. Long-term experience with full-scale installations for micropollutant removal and N recovery gained with the installations at Altenrhein will reduce investment risks, enhance chances of replicability. AVA also gathers the all necessary information to take an investment decision regarding the construction of a PK-fertiliser production unit. This novel thermochemical process transforms sewage sludge into a market grade PK-fertiliser. Thereby heavy metals are partly removed and the fully plant available mineral phase CaKPO_4 is produced. The process has been piloted in a large-scale pilot to gain further operational experience.



4.2.3 Actions and case study objectives

Case Study & Subtask	Technology baseline	NextGen intervention in circular economy for water sector	TRL	Capacity	Quantifiable target
#4 Altenrhein, Switzerland Sub-task 1.4.1	Liquor from sludge dewatering returns to the WWTP	Implementation of a hollow fibre membrane contactor for ammonia recovery as $(\text{NH}_4)_2\text{SO}_4$	TRL 7 → 8	Input: 8 m ³ /h	Production of ammonium sulphate (fertiliser)

4.2.4 Unique selling points and benefits

Unique selling points for ammonium sulphate solution production via membrane stripping are:

- ✓ Reduction of N₂O emissions from the biological treatment
- ✓ High ammonia recovery rates related to the influent to the recovery unit of typically 75%
- ✓ Market-ready product: ammonium sulphate solution as liquid fertiliser

4.2.5 Principal and main characteristics of the technology

Ammonia is a key component for fertiliser production, while ammonia and related compounds in wastewater streams have adverse effects on the receiving water such as algal blooms and toxicity problems. The hollow fibre membrane contactor (HFMC) technology is promising for the recovery and removal of ammonia via stripping from highly-concentrated wastewater flows.

Before the technology implementation in Altenrhein, the HFMC has been implemented at WWTPs in Yverdon, Switzerland and Münster, Germany (KUNST). A total of 10 stripping (membrane, air) plants have been implemented so far. It is suitable for WWTPs for 100 000 population equivalents and more for a side stream treatment of sludge liquor after anaerobic digestion. The Altenrhein plant is the first plant designed and built with pre-existing full-scale experience. Before ammonia membrane stripping can be applied, several pre-treatment steps have to be conducted in order to remove particulate matter and residual organics from the sludge liquor and to reach the required elevated pH and temperature (see chapter 4.2.6). At higher pH and temperature, ammoniacal nitrogen is mainly present as gaseous ammonia (NH₃).

The pre-treated liquor flows through the HFMC containing hollow fibre membranes (see Figure 46). Those membranes are hydrophobic and gas permeable with a pore size of between 10⁻³ and 1 µm. The HFMC has two channels: inside of the hollow fibres (lumen side) and



outside of the hollow fibres (shell side). Due to differences in the ammonia partial pressure across the membrane during operation, the ammonia gas is released from the liquor at the shell side and diffuses to the lumen side. In the lumen side, it reacts with sulphuric acid to liquid ammonium sulphate.

Ammonium sulphate solution is a typical nitrogen fertiliser which can be directly used by the farmers. Typical N concentrations in the product of membrane stripping units range from 19 to 60 kg/m³ of nitrogen (Böhler et al. 2018). The relative fertiliser efficiency is similar to commercially available ammonium sulphate (Szymańska et al. 2019).

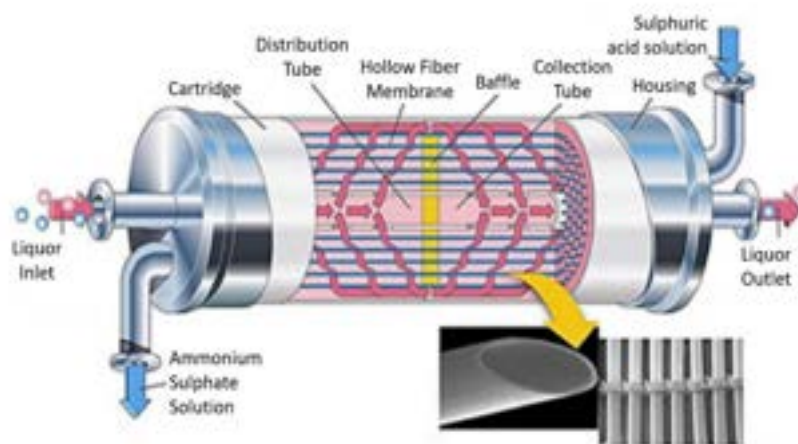

From: <http://powerstep.arctik.tech/nitrogen-removal.php#gai-tech-membranestrip-2>

Figure 46 Left: HFMC in Altenrhein; right: flow scheme of the HFMC

4.2.6 Requirements for the implementation of the technology and operating conditions

In order to reach high ammonia yields, the fraction of ammonium in relation to the total nitrogen content should be as high as possible. Anaerobic digestion combined with a pre-treatment of sludge such as a thermal hydrolysis process can help to improve degradation of organic compounds, resulting in an increase in ammonium concentrations and thus a higher recovery potential.

Several pre-treatment steps for the total removal of solids and particles are an obligatory prerequisite for the application of ammonia stripping membranes, as the membrane tolerance to particles in the influent is very low. Furthermore, temperature and pH need to be increased prior to the stripping process to shift the chemical equilibrium from ammonium (NH₄) to free ammonia (NH₃). First, the temperature is increased with heat exchangers (see Figure 47). Then, in order to increase the pH with minimum chemical demand, CO₂ is stripped out from the liquor. Depending on the chemical composition of the liquor, CO₂ stripping can increase the pH up to 0.4 units, and the buffering capacity of CO₂ is also removed (Böhler et al. 2018). The pH is then further elevated up to a pH of 10 via dosing of sodium hydroxide in order to maximise the ammonia fraction (Table 51). To remove precipitates (mainly CaCO₃) and to prevent fouling and clogging of the membranes, the process is followed by a flocculation and sedimentation step, a sand filtration and finally a cartridge filtration step. Besides the efficient design of the multi-stage pre-treatment process for particle removal, a



major challenge is to find the optimum operating point with a maximised nitrogen recovery at a reasonable demand of chemicals and/or heat. Depending on the type of membrane module, the temperature of the influent liquor should be limited to prevent thermal decomposition of membrane potting. Altenrhein usually operated the process at 40 °C. However, according to the manufacturer a maximum temperature of 50 °C is still possible, but should not be exceeded (Membrana 2021).

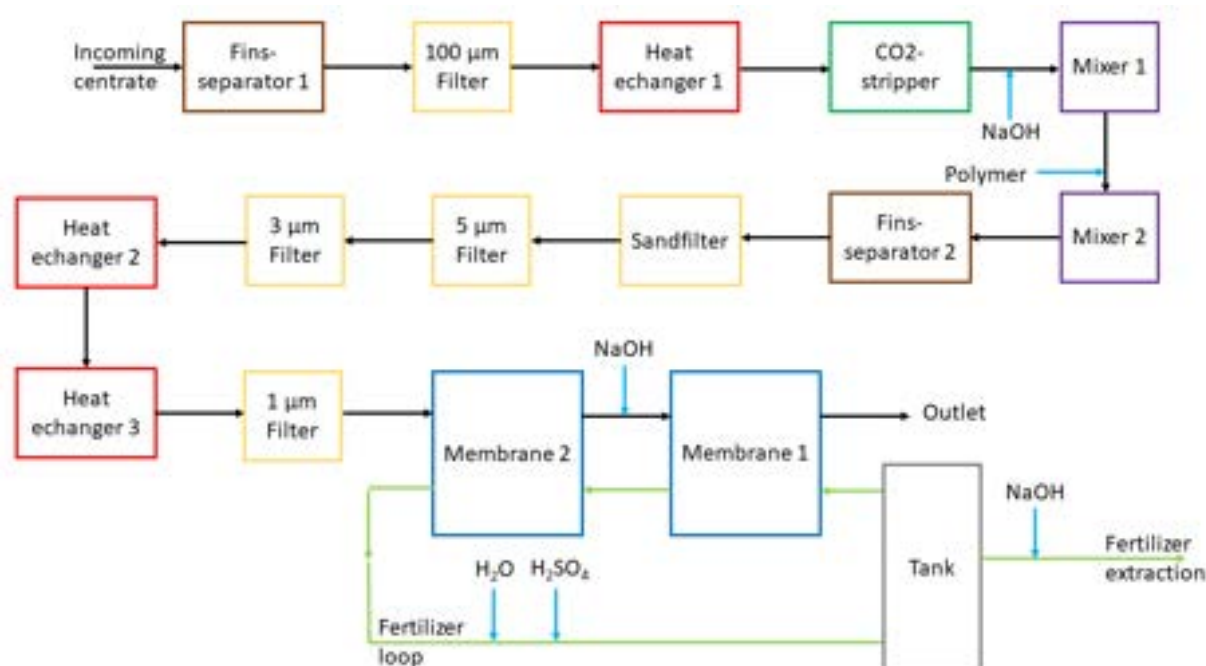

Figure 47 Flow scheme of the ammonia stripping plant in Altenrhein

Table 51 Requirements and operating conditions

Parameter	Units	Min	Max	Reference
NH ₄ (influent)	mg/L	700	>4000	Huang et al. 2020, Böhler et al. 2018, Widmer, A. (2021)
TSS	mg/L	-	1000	Widmer, A. (2021)
pH	-	9	10	Böhler et al. 2018, Widmer, A. (2021)
Membrane Temperature	°C	40	50	Widmer, A. (2021), Membrana (2021)

4.2.7 Results

The plant was taken into operation in summer 2021. After gathering some experience, a more intense monitoring was performed from 4th of October to 23rd of November by Adrian Widmer, FHNW with support of the onsite personnel of AVA and with weekly or biweekly project meetings with AVA, FHNW and the technology providers Membrattec and Alpha.

The goals were to

1. resolve remaining technical issues for high runtime and low maintenance effort for the plant
2. optimise the nitrogen-removal-efficiency of the membranes
3. optimise/reduce the input (chemicals, energy, costs)
4. get an overall idea of what input and effort is required for the technology



To this effect a parameter study for the CO₂ stripping and the membrane stripping was planned. During the measuring campaign we encountered some limitations of the plant and a considerable number of technical problems (see also next section “Technical limitations”). Since the measuring campaign the plant has mostly been idle pending modifications to improve performance and robustness of the process.

Performance

By measuring volumes, runtimes, and ammonium concentration at different points the performance could be characterised. During this period on average 14% of the nitrogen was lost in the first separator as sludge. Out of the remaining N 23% was lost in the pretreatment, 42% recovered in fertiliser and 35% remained in the return flow. The ammonia losses in the pretreatment varied strongly due to the stripping conditions that were varied and to the inlet concentration which varied due to the operation of the digester. They could not yet be predicted and controlled.

The plant is designed for about 10% pretreatment losses, 75% removal as fertiliser and 15% return flow and these values have been reached in a similar plant in Yverdon, Switzerland. The measured N removal at the level of the HFMC membranes was 54% on average. This is in contrast to the observation of Alpha that during the 2 first months of operation at this plant, N removal was around 90%. A third of the losses after the first separator we observed in the side stream (separation of sludge) and two thirds in the form of ammonia stripping. The operation conditions (on average 40°C, pH 9) yielded on average 54 g NH₄-N/L (Figure 48).

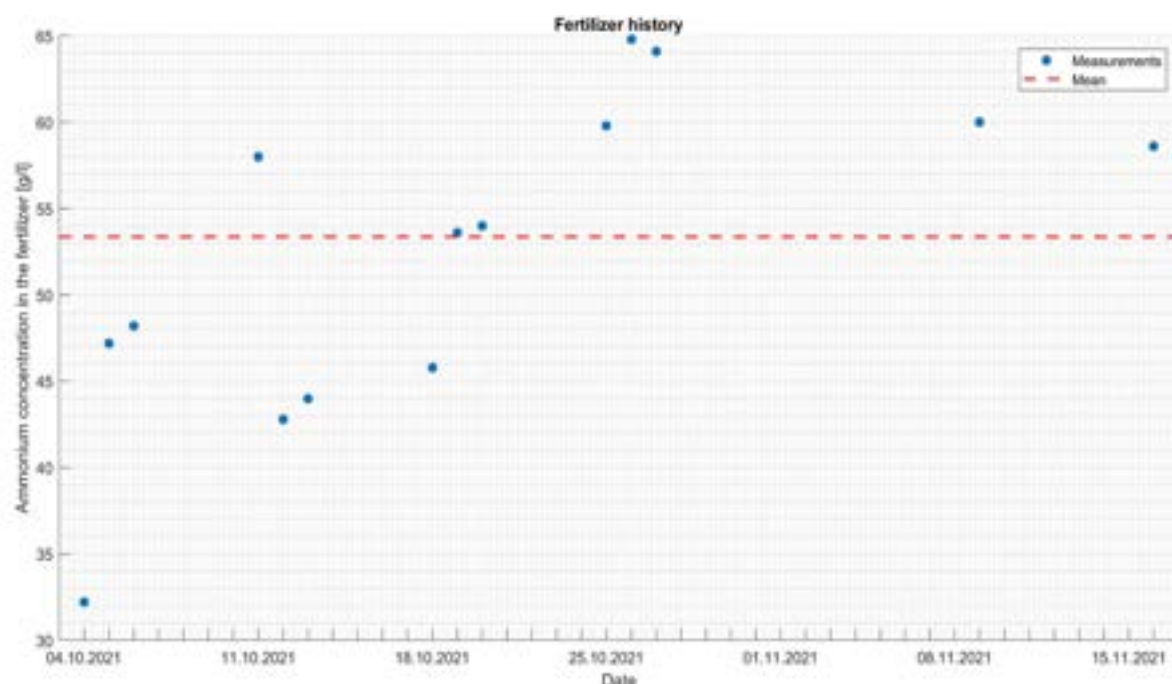

Figure 48 Ammonia concentration evolution over time in the fertiliser

A feasibility study on a forward osmosis unit was performed by Alpha. Based on lab results and measurements in the unit in Yverdon it was shown that with some additional energy input the output could be concentrated up to 80 g NH₄-N/L, which is the limit for safe storage without risk for precipitation.



Different batch tests were performed with the fertiliser produced by the stripping unit of Yverdon (similar concentration to Altenrhein product e. g. 30 to 50 g N /L). The fertiliser was constantly recirculated from a tank through the membrane contactor. A counter-current flow of NaOH (originally) 50% was circulated on the other side of the contactor (Figure 49). When the target concentration is reached (80 g N/L), the fertiliser is extracted to a final storage tank.



Figure 49 Simplified diagramme showing the concentration unit implemented in Yverdon

The concentration and the volume of the fertiliser and of the caustic soda were closely monitored to determine the water fluxes and the impact on the caustic soda concentration.

Table 52 gives a summary of the assays. The production flux of fertiliser by the stripping unit is 42 L/h, with an average concentration of 42 g N/L. The concentration unit is able to increase this concentration to 82 g N/L, meaning that about half of the water contained in the original fertiliser is removed and transferred to the caustic soda solution. As this water flux is 22 L/h (which is half of the fertiliser flux in the stripping units), both processes can work at the same pace.

Table 52 Summary of the main exploitation parameters monitored during 6 weeks of operations.

	Stripping fertilizer			Concentration unit						Caustic soda	
	Volume (m ³)	Flux (L h ⁻¹)	Concentration (g N L ⁻¹)	Operating time (h)	Fertilizer concentration (g N L ⁻¹)	Fertilizer volume (m ³)	N mass (kg)	Water flux (L h ⁻¹)	Water volume (m ³)	Initial concentration (%)	Final concentration (%)
Week 1	0.6	38	26	11	84	0.3	26	29	0.2	35	33
Week 2	5.0	45	50	108	81	1.9	158	25	2.3	33	25
Week 3	1.6	39	45	49	82	0.9	72	19	0.8	25	20
Week 4	3.9	42	45	113	82	2.3	193	19	1.9	20	24
Week 5	4.3	42	43	125	81	2.6	210	19	2.1	24	24
Week 6	3.8	43	41	111	82	2.5	208	19	1.8	24	26
Average	3.2	42	42	86	82	1.8	144	22	1.5	27	25

During these 6 weeks of operation, the concentration of the caustic soda slowly decreased, to reach a concentration of about 25%. This change in concentration explains why the water flux measured in the concentration unit gets smaller over time (from 29 to 19 L/h). The less the caustic soda is concentrated, the slower water is removed from the fertiliser, due to lower osmotic pressure differences. This equilibrium concentration of 25% can then be used to



resize the dosage pump that inject caustic soda in the pretreatment step of the stripping installation, as it is significantly lower than the initial concentration of 50%.

This concentration unit prototype demonstrates that N stripping fertiliser produced by the WWTP of Altenrhein could be easily concentrated on site, with limited OPEX. Indeed, this distillation simply takes advantage of the high concentration of NaOH, but without consuming it. It also relies on a similar type of membrane contactor that is used in the N stripping unit.

The plant was only in operation on average 13 hours per day (Table 53), because of frequent interruptions by the process control system.

Table 53 Average runtimes of the plant over the 51 days

System part	Runtime per day [h]
Pretreatment	13.1
Membranes	12.4
Fertiliser extraction	2.6

Technical limitations, energy and materials consumption

The centrate quality was monitored (Figure 50). Especially the strongly varying ammonium concentration leads to varying operation conditions in the plant. The average ammonium (1300 mg N/L) concentration was higher than the design concentration (900 mg N/L). Therefore, the NaOH dosage pump is at its limits (Table 54) and this is part of the explanation why N removal by the membrane is lower than what was expected.

The characteristics of all relevant pumps and other aggregates were recorded and their power usage and energy consumption calculated. Machines with a different runtime compared to the overall production time of the plant, were considered with the data of the process control system. The plant uses two heat exchangers to transfer heat to the input stream from the output stream. Additional heat is added with the WWTP thermal oil heating system to make up for losses. During the measuring campaign data on both specific heat consumption and specific chemicals consumption could be gathered.

A number of technical problems could be solved, thus improving the functioning and reducing the downtime of the plant (Table 54).



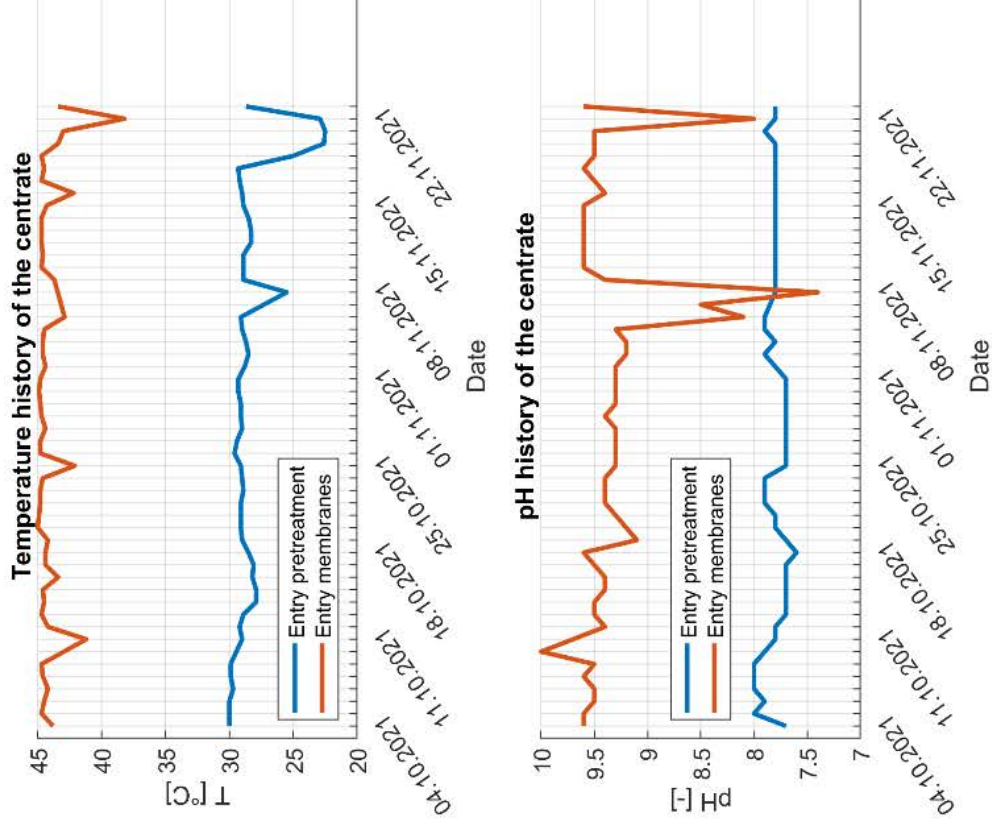
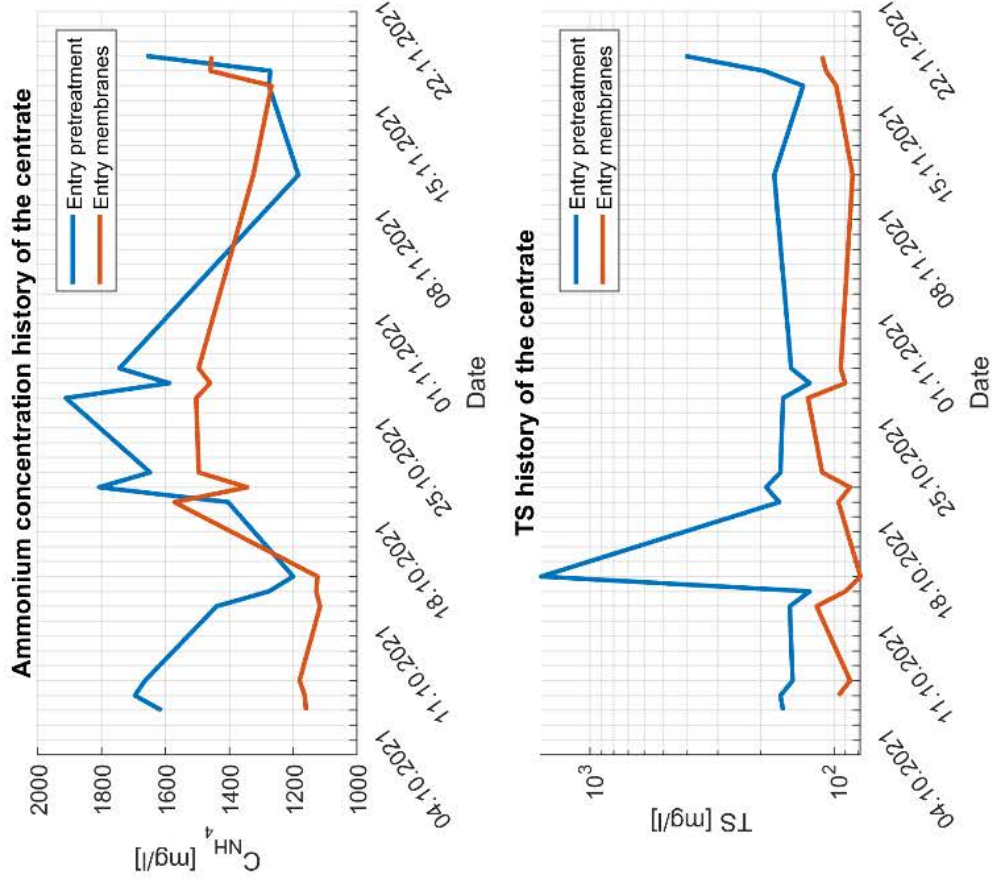

Figure 50 Evolution the centrate quality over time

Table 54 Encountered technical problems and solutions

Problem	Status
Inferior acid quality, contaminated with iron and organics, which had precipitated in the membranes and which led to a loss of membrane integrity	Partly solved. When the measuring campaign started, the recovery efficiency was already below the design efficiency and with time the efficiency dropped further (Figure 51). This is explained by the loss of membrane integrity and by a clogging of the membrane fibres, both due to iron contamination. Standard cleaning program and manual acid-base cleaning was not sufficient. After the measuring campaign the membranes were sent for more thorough cleaning by the provider, but a complete recovery of membrane performance seems unlikely.
Undersized pump for the extraction of the fertiliser	Partly solved. The loss of membrane integrity and the high N concentrations in the centrate caused a bigger production flow of water from the centrate to the fertiliser, which was too important for the extraction pump. Replaced, but probably larger pump needed.
Undersized caustic soda pump	Solved. The pump was dimensioned for a lower N concentration in the centrate and was close to its limit.
Undersized sulfuric acid pump	Solved. The pump was dimensioned for a lower N concentration in the centrate and was close to its limit. Pump head changed and pump recalibrated.
Wrong computation of thermal power from heating system	Solved
High loss of N during pretreatment	Not solved yet, but several possible options are being pursued: <ul style="list-style-type: none"> • A better separation of fines in the centrifuge to reduce the sludge in the first separator. This sludge could also directly be recycled to the dewatering, thus minimising process efforts. This sludge thus causes relatively small efforts compared to losses to air that occur later. • Optimisation of the CO₂ stripping to reduce co-stripping of NH₃ • Less ventilation of the tanks to reduce NH₃ evaporation.



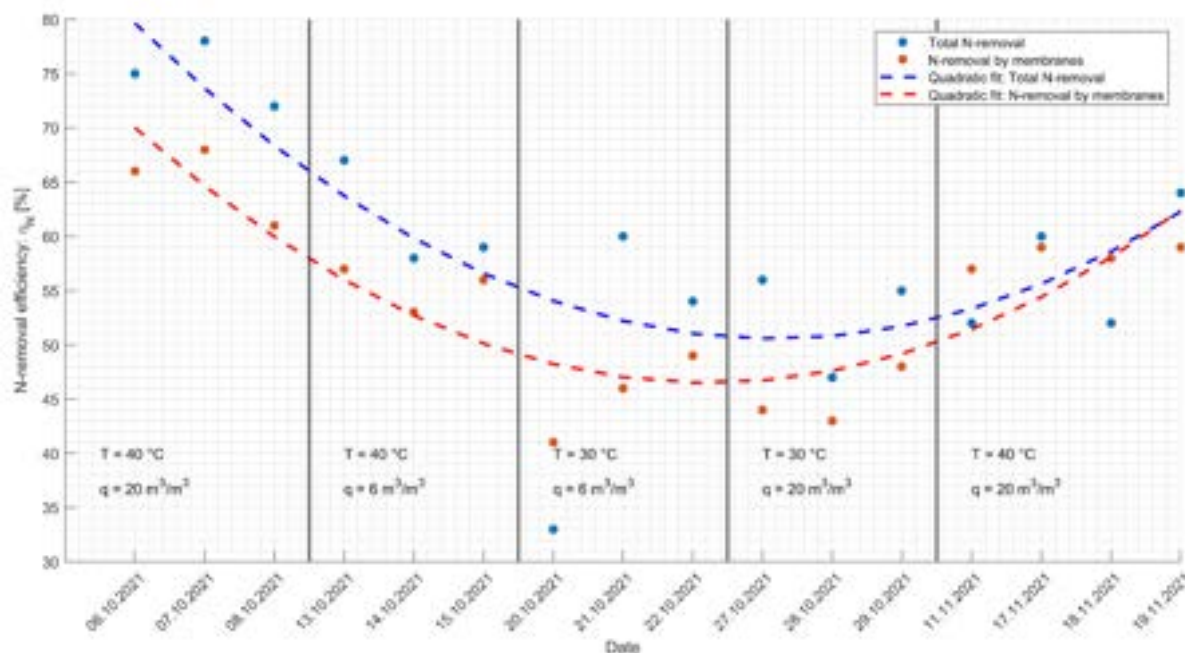

Figure 51 Removed fraction of nitrogen in total and by the membranes over the 51 days

4.2.8 Comparison of the baseline situation and the NextGen KPIs

The observed capacity and estimated potential were summarised in Table 55. When standard runtime (7.500 h/a) can be achieved the plant will have the capacity to treat the total amount of centrate in Altenrhein. Some aggregates might have to be re-dimensioned (e.g. NaOH dosage).

The specific energy and chemical consumption (NaOH, H₂SO₄) of the new plant could be characterised. These are equivalent or better than the plant in Yverdon. This is crucial, since NaOH consumption is the main driver of cost and environmental performance of this process. The losses in the pre-treatment are higher than expected and the membranes were partly clogged. AVA and Alpha expect that to reach the specified yields once the plant has been overhauled.

The recovery of ammonium as a fertiliser is a nice effect of the stripping process. However, the following advantages might be more decisive for choosing this technology:

- Reduction of N₂O emissions in the biological treatment
- Reduction of aeration and tank size needed for the denitrification in the biological treatment and/or
- Reduction of the nitrogen concentration in the effluent

Table 55 Characteristics of the Altenrhein plant, characteristics of the Yverdon plant (first plant delivered by Alpha) and estimated future performance of the Altenrhein plant

	Measured	Membrane stripping plant in Yverdon	Expected value, basis for assessment
Throughput	133 m ³ /d 13 h/d 10.2 m ³ /h	90 m ³ /d 22 h/d 4 m ³ /h	10.2 m ³ /h 7500 h/a 77'000 m ³ /a
Product concentration (g NH ₄ -N/L)	54	80 (after a concentration step)	77
Specific electricity consumption (kWh/m ³)	0.5	1.5 ⁴	Stripping: 0.5 Concentration: 0.15
Specific heat consumption (kWh/m ³)	8	21 ⁴	8
Specific NaOH consumption (mol/(mol N ¹))	0.9	1.5	1
Specific H ₂ SO ₄ consumption (mol/mol N ¹)	0.6	0.6	0.6
Loss in first lamella separator (%)	14		15
Lost in pretreatment (%) ²	23		3 (sludge)+7 (air) ³
In fertiliser (%) ²	42	78	75
Return flow (%) ²	35	18	15

¹ Mol N at the point of contact, not at the inlet



² Based on the stream after the first lamella separator

³ Recycled to the digester via the acid scrubber

⁴ Böhler et al. 2015



4.2.9 Lessons learned

<p>Required competence</p>	<p>LOW  HIGH</p>
<p>A trained wastewater treatment foreman with training on the job can operate the plant. Safety training for the use of strong acids and bases is necessary.</p>	
<p>Maintenance</p>	<p>LOW  HIGH</p>
<p>The plant requires about one full day of maintenance monthly. Active intervention from the operator including unforeseen events requires about one hour per day. No external experts are required for maintenance. Alpha and Membrattec expect to reduce the need for maintenance drastically in 2023.</p>	
<p>Technological risks</p>	<p>LOW  HIGH</p>
<p>Downtimes are caused by failures of instruments and the process control system and failure of machines, and by automatic cleanings of some elements.</p> <p>The frequency of plant downtimes in stable operation cannot yet be estimated. The first half year they were frequent. Downtimes can vary from a few hours to several days or weeks if a machine needs to be repaired or replaced.</p> <p>The pretreatment is operated and serviced by the WWTP. In contrast the membrane plant will require expertise from the technology provider (Alpha) for service and startup, likely several times every year.</p> <p>Like for many plants proper maintenance and sufficient spare parts can reduce downtimes.</p>	

4.2.10 Best practice guideline to design and operate the technologies

Plant construction requires normal project management with submissions etc. Since the process is not yet state of the art guaranteed performance values are of great importance. The business case has large uncertainties due to strongly fluctuating price dependence on international supply. The high consumption of chemicals increases cost uncertainty.

It is important that the WWTP is equipped with a centrifugation step allowing to separate efficiently the liquid from the solid anaerobic sludge. Ideally, the centrate should contain less than 100 mg TSS/L. It is also advisable to have a tank (> 100 m³) big enough to store centrate between the centrifugation and the stripping steps in order to enable constant input flow and concentration.

Operating parameter ranges are summarised in Table 56.



Table 56 Best results were obtained with the presented operating conditions

	Range, concern	Concerns
CO ₂ stripping temperature	30 - 40 °C	limit ammonia loss
CO ₂ stripping air flow	5 - 20 m ³ /(m ³ centrate)	limit ammonia loss
Ammonia stripping pH	9 - 10	limit NaOH consumption
Ammonia stripping temperature	40 - 50 °C	ammonia yield, membrane stability, water diffusion, heat consumption



4.3 Ammonium sulphate production via ion exchange and hollow fibre membrane contactor in Spernal (UK)

Authors: Ana Soares (UCRAN) and Peter Vale (Severn Trent)

4.3.1 Description of the demo site

Spernal wastewater treatment plant (WWTP) is a medium sized plant serving the towns of Redditch and Studley located approximately 24 km south of Birmingham (UK) (Figure 52). The site has a dry weather flow of 1'150 m³/h (or 27'6000 m³/day) serving 92'000 population equivalent. Spernal WWTP includes a preliminary treatment, primary treatment, an activated sludge plant, secondary clarifiers, and sand filters. The treated effluent is discharged to the River Arrow, which is designated as a sensitive area under the Urban Wastewater Treatment Directive (UWWTD) and has an overall water body status of moderate under the Water Framework Directive (WFD). The sludge produced on site, and other local rural works, is further treated in anaerobic digesters and dewatered before being recycled to local farmland and industries. The biogas produced by digesters is burnt in combined heat and power (CHP) engines to produce heat and electricity.



Figure 52 Location of the Spernal wastewater treatment plant (WWTP) within the United Kingdom (left) and local map (right).

Spernal serves as Severn Trent Water's "Urban Strategy Demonstration Site" where emerging technologies compatible with low energy demand, low greenhouse gas emissions and a circular economy approach are being evaluated (Figure 53). The "Urban Strategy Demonstration Site" contains all the infrastructure; power, wastewater feed, drainage, telemetry and biogas handling equipment necessary for the NextGen trials, together with office and laboratory facilities. Among the technologies tested is a multi-stream demonstration scale anaerobic wastewater treatment plant for carbon management and ion exchange processes for nutrient management (Figure 54). The demonstration plant incorporates an anaerobic membrane bioreactor (AnMBR) complete with a membrane degassing unit to recover dissolved methane. AnMBR combines several benefits such as: no aeration energy for removal of COD/BOD, low sludge production and associated treatment efforts, biogas production (production of electricity/heat), pathogen and solids free effluent which can be re-used in several applications (e.g.: farming and industrial use). The ion



exchange (IEX) process enables targeted ammonia (N) and phosphorus (P) removal and recovery to produce a high quality effluent whilst recovering calcium phosphate salts and ammonia sulphate solutions.



Figure 53 Areal picture showing the Urban Strategy Demonstration Site at Sernal WWTP and the location where the NextGen demonstrator was built

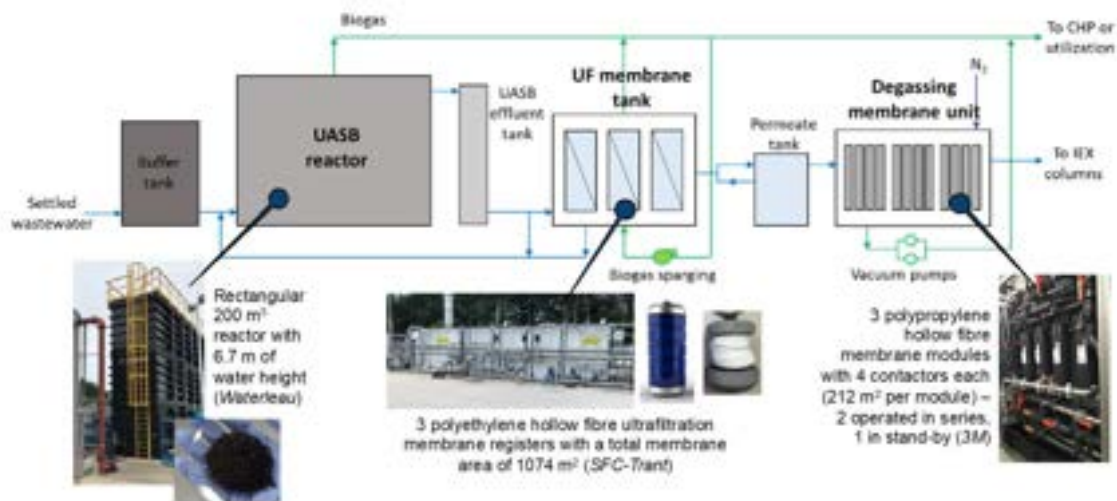

Figure 54 Areal picture showing the NEXT-GEN demonstrator including the anaerobic membrane reactor and degassing unit (top) and the schematic representation of the process (bottom).



The data gathered at the Spernal WWTP innovative technology flowsheet aims to demonstrate and showcase the viability of this transformative approach to wastewater treatment in cold- climate northern European countries, enabling a future of energy recovery combined with effective recovery of nutrients. The project confirms the optimal design and operating parameters to deliver a comprehensive energy balance and cost benefit assessment.

4.3.2 Motivation of implementing circular economy solutions in the water sector

The water sector is a relatively large user of energy and a significant emitter of fugitive greenhouse gases (nitrous oxide and methane) it is therefore incumbent on water utilities to address the challenge of climate change by striving to reduce its carbon footprint. Transitioning to a more circular way of operating; reducing the amount of energy and chemicals required in treating water and recovering and reusing the energy, materials and water that is plentiful in wastewater will become a central strategy of water utilities.

The AnMBR/ion exchange flowsheet, once proven, can deliver an energy neutral wastewater treatment process, reduce process emissions by removing the main contributor to nitrous emissions – biological nitrification and denitrification and facilitate resource recovery through producing a solids free disinfected effluent ideal for nutrient (N and P) recovery and/or the recovery of water and nutrients through fertigation.

4.3.3 Actions and case study objectives

Case Study & Subtask	Technology baseline	NextGen intervention in circular economy for water sector	TRL	Capacity	Quantifiable target
#5 Spernal, United Kingdom Sub-task 1.4.5	Spernal WWTP serves as Severn Trent Water’s “Urban Strategy Demonstration Site”	Nutrient recovery via adsorption / ion exchange (IEX): N removal (zeolite column) & N recovery (ammonia stripping or membrane processes)	TRL 6 →7	10 m ³ /d nutrient stripped effluent	Ammonia stripping or membrane processes can be used to produce ammonia solution at 3-5% or ammonium sulphate, respectively.



4.3.4 Unique selling points

Ion exchange (IEX) for nutrient ammonia and phosphorus removal and recovery and the hollow fibre membrane contactor (HFMC):

- ✓ High recovery rates: up to 95% of ammonia and 90% of phosphorous
- ✓ High product water quality which can be used in the chemical and fertiliser industry
- ✓ Low energy consumption
- ✓ Simple equipment and low maintenance cost
- ✓ Compact system with very small footprint
- ✓ No sludge production
- ✓ No start-up period required (can be switch on or off on demand)
- ✓ Low chemical consumption due to regenerants restoration and re-use

4.3.5 Principal and main characteristics of the technology

Ion exchange (IEX) is one of the promising technologies for removal and recovering nutrients from wastewater streams. Currently, the most used ion exchange media for ammonium removal are zeolites. These contain a crystalline aluminosilicate mineral within a framework of silica and aluminium tetrahedra linked by their corners through oxygen atoms. Cations present in the wastewater (usually NH_4^+ , Na^+ , Ca^{2+} , K^+ and Mg^{2+}) can penetrate inside cages and channels within the zeolite matrix and be exchanged with the surroundings. Engineered zeolites, like the one used in NextGen, have suffered chemical modifications to increase their selectivity towards ammonium.

The components of the demonstration plant IEX include a compressed air diaphragm pump, storage tank for the regeneration chemical, 1 IEX column of zeolite-N resin for ammonia removal (Figure 55). The IEX column for ammonia removal was 22 cm in diameter and 158cm in height. The column was filled with 28 L of zeolite-N to have an empty bed contact time of 40 min. Shorter empty bed compact times would be possible with this technology (10 min of N removal) but the operation was limited to volume of AnMBR effluent that could be transported and stored, at around 1 m³/d over 5 days a week. This was related with restrictions at Sperial WWTP to house the IEX demonstration plant, as an alternative this was located at the Cranfield University UKCRIC National Research Facility for Water and Wastewater Treatment. The entire demonstration plant was assembled on a steel rack. The ion exchange media must be regenerated when the desired effluent concentration is reached. The regenerant solutions used are 2% NaOH solution. The nutrients were then recovered from the saturated regenerant.

Ammonia was recovered in the form of ammonium sulphate, $(\text{NH}_4)_2\text{SO}_4$ via a membrane stripping system with sulphuric acid (H_2SO_4). For this, a commercial hollow fibre membrane contractor (HFMC) (Liqui-Cel® 1.7x5.5 MiniModule®, Membrana GmbH, Wuppertal, Germany) was used to strip ammonia from the concentrated solutions in contact with a 2% wt. sulfuric acid (Figure 55).



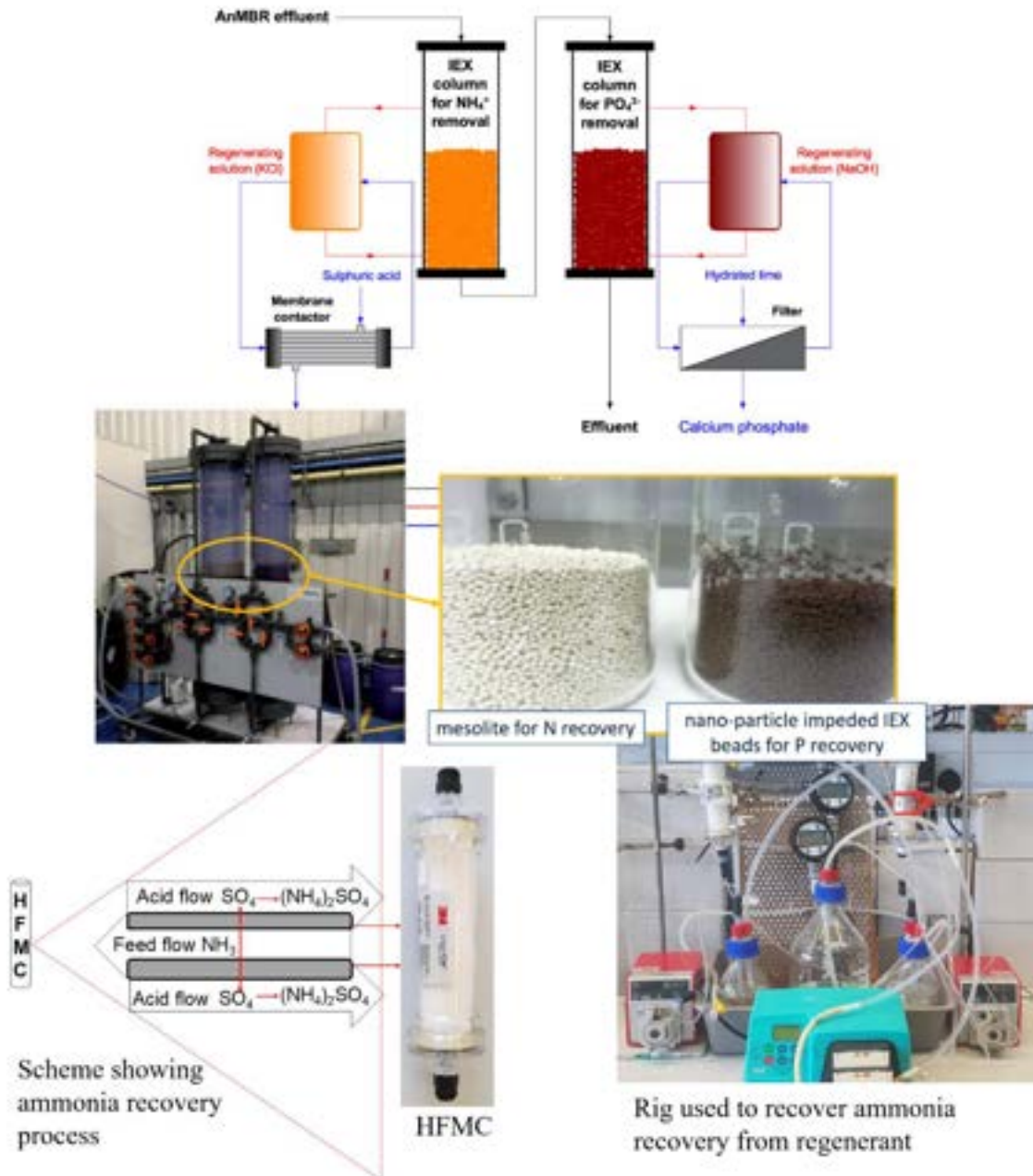

Figure 55 Schematic representation of the ion exchange plant for ammonia and phosphorus removal and recovery (top) and pictures of the technology at Cranfield University (middle) and ammonia recovery technology (bottom)

4.3.6 Requirements for the implementation of the technology

It is required to have nearly no solids and low organic matter. This is because solids will cause plugging in IEX columns and elevated organic matter concentration can cause biological fouling of the media. Full technology requirements are described in Table 57.



Table 57 Required operating conditions of the IEX process for nutrient removal and recovery

Technology	Parameter		Units	Mean	Reference
Ion exchange	IEX Influent	Flow rate	m ³ /d	1-10*	Own data
		Temperature	°C	4-25	
	IEX Effluent	Flow rate	m ³ /d	1-10*	
		Temperature	°C	4-25	
Ammonia membrane stripping system	Regenerant NH ₄ -N		mg/L	400-1000	
	Ammonia mass transfer, KLa		L/h	0.5-2	
	N recovery rate		%	95	
	H ₂ SO ₄ consumption		t/a	0.2	

* flow matches the IEX design for this specific project, very simple to upscale to higher flows

4.3.7 Results

The influent NH₄-N concentration to the IEX was relatively high at 56.9 ± 9.73 mg NH₄-N/L (Figure 56). The first 325 bed volumes (BV) operation where aimed at reaching saturation, i.e., a breakthrough curve. In this first cycle, the effluent NH₄-N concentration increased from 5.3 mg NH₄-N/L and reached 28.6 mg NH₄-N/L. Further to this, in the breakthrough curve, the bed saturation was not reached as the ammonia concentration to influent ammonia concentration ratio (C/Co ratio) was 0.6 meaning that saturation was not achieved and the adsorption capacity was 10.6 mg NH₄-N/g media. Then the first regeneration was conducted.

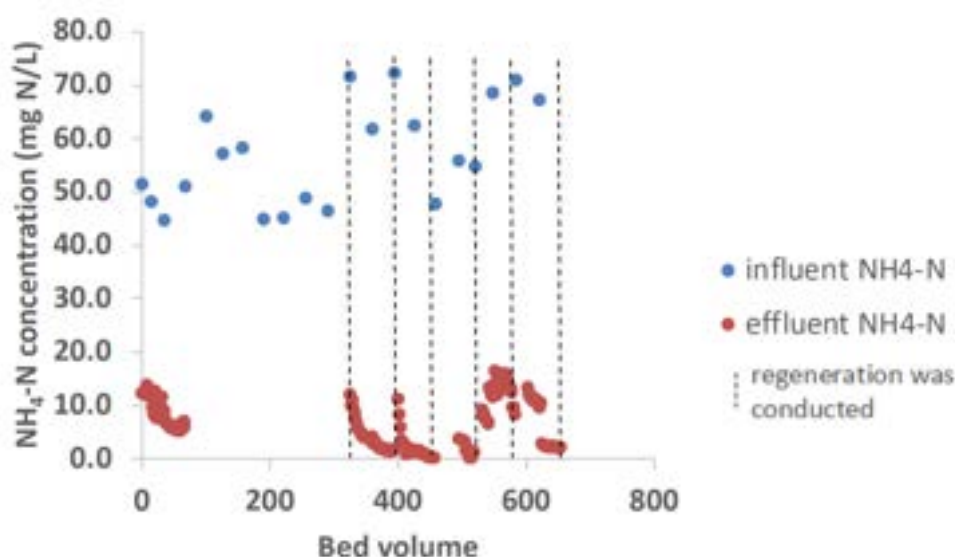

Figure 56 Influent and effluent ammonia concentrations during operation of IEX demonstration plant

After the 1st adsorption cycle, the following regenerations were applied after 2 m³ of AnMBR effluent was treated. Figure 56 shows the IEX influent and effluent NH₄-N concentrations against BV treated from the 2nd to 6th adsorption cycles. Throughout the operation from 1st to 6th adsorption cycles, the average effluent NH₄-N concentration was 1.6 mg NH₄-N/L, with an average removal of 97.3%. When looking at the shape of the curve of the effluent ammonia concentration after regeneration, it is possible to see that concentration took some BV to decrease, this was likely due to poor rising of the regenerant in between cycles. The IEX process was oversized (i.e., the IEX column had a very large size and capacity, as it was



designed to process at least 10 times the used influent flow here used, limited to 1 m³/day). Only 1 m³/day anMBR effluent could be transported from Sernal to Cranfield due to transporting company requirements and restricted storage space on both sites (a fact that only came to light at the very start of the tests), nevertheless the IEX design was made for 10 m³/day of anMBR effluent. As such, the IEX column was large and not rinsed properly with only 1 BV of water after regeneration. This led to high ammonia concentrations left in the column walls and still around the media after regeneration and that it took some BV of operation with wastewater to be completely washed away and ammonia adsorption to be recorded. Nevertheless, the process was efficient and high ammonia removal was achieved. The ammonia exchange capacity obtained was similar to previous studies completed at a range of scales and also with secondary effluents origination from trickling filters Table 58.

Table 58 IEX media for ammonia removal and exchange capacity from other studies

Bench test/ pilot plant	IEX media	Ammonia exchange capacity	Regenerants used	Reference
Bench scale	Zeolite-6	0.18-17.15 mg NH ₄ - N/g media	10% KCl	(Guida et al. 2020)
	Zeolite-N	2.35-23.83 NH ₄ -N/g media		
10 m ³ /d, demo plant using trickling filter effluent from WWTP	Zeolite-N	0.9-17.7 mg NH ₄ /g media	10% KCl	(Guida et al. 2021)

The regenerant accumulated high concentrations of ammonia (Table 59) that could be recovered in the HFMC process.

Table 59 Ammonia concentrations in regenerant at the end of each regeneration

Regeneration cycle	NH ₄ -N concentration in regenerant (NH ₄ -N in mg/L)
1 st (end)	1090
2 nd (end)	1540
3 rd (end)	1745
4 th (end)	1750
*5 th (end)	334
6 th (end)	660

*new regenerant was prepared for the 5th regeneration cycle onwards

The NH₄-N concentrated in the IEX brine was recovered by HFMC and the recovery efficiency (NaCl 10%, pH 11) reached to 99.8% (complete recovery) after the recirculation of the brine 360 times through the HFMC corresponding to a total operating time of 6.7 hours (Figure 57). In brine with an initial ammonia concentration of 890 mg NH₄-N/L was decreased to 25 mg NH₄-N/L after 250 cycles in the HFMC. The dissolved ammonium sulphate that accumulated within the acid side was then recovered as a solid product by evaporation of the acid phase. The chemical characterization of the product recovered from the IEX brine was analysed by energy-dispersive X-ray spectroscopy (EDX) analysis and the elemental composition of ammonium sulphate was identified in atomic percentage which was revealed the purity of the



product. The elements comprising ammonium sulphate were solely detected and the proportions were found to be close to the chemical formula of ammonium sulphate (Table 60).

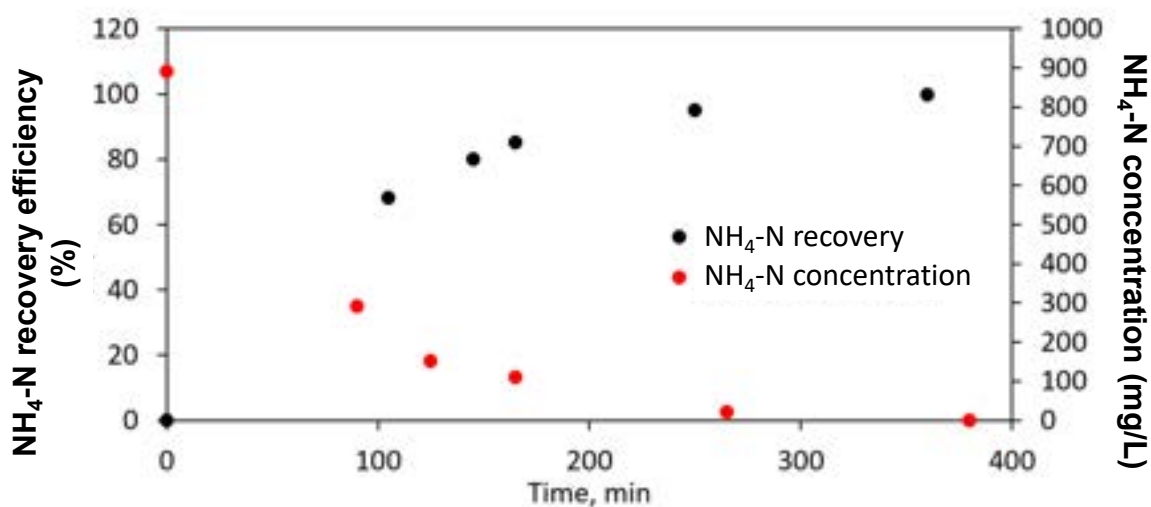

Figure 57 Ammonia concentration in the treated brine and the NH₃ recovery efficiency by HFMC

Table 60 EDX analysis of the recovered ammonia product

	Elemental composition (atomic %)		
	N	O	S
Ammonium sulphate (chemical formula)	28.6	57.1	14.2
Ammonium sulphate (recovered product from IEX)	25.5	55.6	18.8



4.3.8 Comparison of the baseline situation and the NextGen KPIs

The existing Spernal WWTP constitutes the base case to provide a comparison to the NextGen Spernal demonstrators. The base case is shown in (Table 61):

Table 61 Base case: Spernal WWTP flow rates, standard influent and effluent parameters

Parameter	Units	Mean value	Standard deviation	Frequency of the measures	Summer mean value	Standard deviation	Winter mean value	Standard deviation	Considered years for the analysis
Influent									
Flowrate	m ³ /h	1267	447	Daily	1114	344	1422	484	2018
Effluent									
Flowrate	m ³ /h	1097	324.7	Daily	921.4	195.8	128	330.7	2018
Influent to the Spernal WWTP									
COD	mg O ₂ /L	861.2	520.8	Twice per month	947.7	604.5	759	405.1	2018
BOD ₅	mg O ₂ /L	276.1	172.3	Twice per month	322.7	192.8	221.1	132.3	2018
TSS	mg/L	515.2	300.6	Twice per month	536.9	358.3	489.6	228.9	2018
TN	mg N/L	32.6	7.1	twice per month	34.7	4.3	30	9	2018
NH4-N	mg N/L	31.0	8.2	Twice per month	34.2	4.6	27.2	10.0	2018
TP	mg P/L	7.5	3.3	Twice per month	8.46	3.5	6.3	2.9	2018
Effluent from the Spernal WWTP									
COD	mg O ₂ /L	44.6	11.5	Twice per month	43.69	11.1	45.7	12.4	2018
BOD ₅	mg O ₂ /L	3.6	2.7	Twice per month	4.2	2.7	2.9	2.6	2018
TSS	mg/L	9.8	6.9	Twice per month	7.2	3.6	12.8	8.6	2018
TN	mg N/L	34.5	5.2	Twice per month	34.1	5.6	35.0	4.9	2018
NH4-N	mg N/L	2.4	1.1	Twice per month	2.0	1.0	2.8	1.1	2018
TP	mg P/L	1.2	0.3	Twice per month	1.2	0.3	1.1	0.3	2018

The Spernal WWTP is a medium sized plant and treats an average daily flow of 27 ML/d to a 10 mg BOD/L, 25 mg TSS/L, 5 to 10 mg NH₄-N/L and 2 mg P/L standard. The plant includes a preliminary treatment (6 mm screening and grit removal), conventional primary settlement tanks with iron dosing for P removal, secondary treatment comprising of trickling filters for 33% of the flow and activated sludge for the remainder and tertiary sand filters.

Effluent from the plant presents COD of 44.6 ± 11.5 mg/L, BOD of 3.6 ± 2.7 mg/L, total suspended solids (TSS) of 9.8 ± 6.8 mg/L; a total nitrogen (TN) content of 34.5 ± 5.18 mg/L, and a total phosphorous (TP) of 1.18 ± 0.3 mg/L. In this case, the quantity of microorganisms for both influent and effluent is not shown as it is not measured regularly. The overall quality of both influent and effluent is better during the winter period.

In addition, the effluent from Sernal base case is defined in Table 62, and compared with the effluent from the combined NextGen technologies tested, i.e., the effluent from the IEX system.

Table 62 Effluent quality – potential water for re-use produced in the base case and NextGen

Parameter		Units	Mean value	Standard deviation	Frequency of the measures
Base case Influent	Flowrate	m ³ /h	1267	447	Daily
Base case Effluent	Flowrate	m ³ /h	1097	324.7	Daily
Effluent from the Sernal WWTP	COD	mg O ₂ /L	44.6	11.5	Twice per month
	BOD ₅	mg O ₂ /L	3.6	2.7	Twice per month
	TSS	mg/L	9.8	6.9	Twice per month
	TN	mg N/L	34.5	5.2	Twice per month
	NH ₄ -N	mg N/L	2.4	1.1	Twice per month
	TP	mg P /L	1.2	0.3	Twice per month
Effluent from NextGen (after all processes including IEX)	COD	mg O ₂ /L	Still being determined but <50	19	Daily
	BOD ₅	mg O ₂ /L	Still being determined but <25	10	Daily
	TSS	mg/L	< 1		Daily
	TN	mg N/L	< 1		Daily
	NH ₄ -N	mg N/L	< 2		Daily
	TP	mg P /L	< 1		Daily
	<i>E.coli</i>	CFU/100 mL	Still being determined but <3350		Monthly
	Total Coliform	CFU/100 mL	Still being determined but <8700		Monthly
Faecal Coliform	CFU/100 mL	Still being determined but <4600		Monthly	



No products are recovered yet at the base case in Sernal at the full-scale treatment plant with activated sludge as secondary treatment process.

However, according to the outcome of the lab tests, 1.1 kg (NH₄)₂SO₄/d with an influent flow rate of 500 m³/d are expected to be produced as solid crystals. This corresponds roughly to 19.4 t (NH₄)₂SO₄/a (i.e., 2.05 t N/a) that might be expected from a full-scale plant referring to 100,000 PE.

The quality of the recovered product can be found in Table 60. More detailed analysis is being completed for the ammonium sulphate, but not yet available.



4.3.9 Lessons learned: ion exchange process for ammonia and phosphorus removal and recovery

Required competence	
The ion exchange and ammonia recovery units are new technologies for the water sector with a complex operation. Knowledge of the specific operation and maintenance procedures are necessary.	
Maintenance	
The frequency of plant maintenance per month comprises roughly two days. The duration of a normal maintenance procedure is 2h and the duration of active process control per day (manual process control, unforeseen events) is roughly 1 h. No external experts are required to conduct the maintenance procedure.	
Technological risks	
A reason for a downtime might be, that the effluent quality is not maintained by frequent regenerations, because it is missed due to spot sampling alone. However, plant downtimes have not been observed so far. A measure to avoid such a downtime is having a full automated plant with online sensors, which trigger regenerations.	

4.3.10 Best practice guideline to design and operate the technology

Important to consider during the construction of the plant:

- process has a bespoke design,
- understanding of contact times,
- availability of IEX media and
- health and safety related aspects of chemical storage

Crucial for the start-up of the plant is an operator training for a good process understanding.

Parameters that are crucial for the optimisation of the production process:

- empty bed contact times,
- regeneration frequency,
- product recovery routines
- recover regenerants achieving a low chemical input process

The ranges for those to gain the best removal and production results still need to be clarified via a full plant automation with the required sensors.



5. Phosphorus removal and recovery

Three cases studies investigated different technologies to recovery phosphorus. In Braunschweig, a struvite production unit was implemented with a TRL of 9, in Altenrhein, a PK-fertiliser production pilot plant was constructed with a TRL of 7 and in Sernal, a hydroxyapatite production unit was installed with a TRL of 6.

5.1 Struvite production in Braunschweig (GER)

Authors: Anne Kleyböcker (KWB) and Janina Heinze (AVB)

5.1.1 Description of the demo site

The wastewater treatment plant Steinhof, near Braunschweig, has a long tradition of water and nutrient reuse. Already at the end of the 19th century, fields were irrigated with sewage. From 1954 on, the wastewater was mechanically clarified and reused for irrigation. Finally, in 1979, the wastewater treatment plant (WWTP) was built and comprised a conventional activated sludge treatment system and a digestion stage. Until 2016, in summer, the digestate was directly reused in agriculture, while in winter, the digestate was dewatered and stored until the summer season. However, due to the new legislation in Germany, since 2017 only 60% of the digestate can be applied on the fields. The reasons are restricted periods for fertilising with digested sewage sludge and the limitation of the nitrogen load to the agricultural fields. Thus, the other 40% of the digestate were dewatered and incinerated.

In 2019, a new circular economy concept was implemented. Here, energy recovery technologies are combined with nutrient recovery technologies. Therefore, the sludge management concept was adapted to increase the nutrient recovery rate and simultaneously, as a synergetic effect, the biogas recovery rate increased. Hence, circular economy solution comprises a thermal hydrolysis process between two digestion stages and a full-scale nutrient recovery plant consisting of a struvite production unit to recover phosphorus and an ammonium sulphate solution production unit to recover nitrogen.

The secondary fertilisers will be reused by the local farmers and the produced energy in the form of biogas and heat is reused by the plant itself.

5.1.2 Motivation of implementing circular economy solutions in the water sector

The original WWTP was designed for 275 000 population equivalents. However, the actual load refers to 380 000 population equivalents. In order to guarantee a clean effluent of the WWTP complying with legal thresholds, a circular economy approach was implemented not only to remove nutrients from the wastewater, but also to recover them in combination with an enhanced energy recovery system. In detail, phosphorus and nitrogen are recovered via the production of struvite and ammonium sulphate and the biogas production rate is enhanced due to a thermal pressure hydrolysis.

Benefits of a struvite production unit are:

- ✓ Reduction of the phosphate return load of a WWTP



The WWTP profits from the reduced phosphate return load. Thus, a part of iron or aluminium salts often used for a conventional chemical removal might be saved due to the lower return load.

- ✓ Prevention of clogging events in pipes

Depending on the chemical composition of the wastewater and the pH conditions, struvite can precipitate in undesired parts in the wastewater treatment plant e.g. in pipes leading to scaling and clogging. Due to a controlled removal of the phosphate from the liquor, those processes will be diminished or even avoided in the subsequent plant parts.

5.1.3 Actions and case study objectives

Table 63 Action and case study objective in Braunschweig regarding struvite production

Case Study & Subtask	Technology baseline	NextGen intervention in circular economy for water sector	TRL	Capacity	Quantifiable target
#1 Braunschweig, Germany Sub-task 1.4.7	Irrigation and fertilisation of agricultural fields with WWTP effluent and digestate	Phosphorus recovery for struvite production	TRL 9	Around 300 t/a struvite corresponding to 37 t P/a and 17 t N/a	Struvite production: ≥80% recovery from P load to recovery unit

5.1.4 Unique selling points

Unique selling points for the production of struvite from process water and other advantages are:

- ✓ High phosphorus removal and recovery rates related to the influent to the recovery unit of up to 97%
- ✓ Struvite is a high quality product which can be used in agriculture as slow release fertiliser
- ✓ Reduced struvite scaling in pipes and pumps downstream the struvite production unit
- ✓ Significant reduction of the phosphorus return load

5.1.5 Principal and main characteristics of the technology

In the case study Braunschweig, three different technologies were implemented that are interconnected with each other:

- Thermal pressure hydrolysis,
- Struvite production and
- Ammonium sulphate solution production via air stripping and gas scrubbing.

This chapter presents the principal and main characteristics of the struvite production.



In the wastewater sector, struvite is usually used as a name for magnesium ammonium phosphate ($\text{MgNH}_4\text{PO}_4 \cdot 6\text{H}_2\text{O}$), even though it is the name of a mineral family. Struvite is a slow release fertiliser (Kratz et al. 2019) and all three nutrients are plant available as from mineral fertilisers (Watson et al. 2019).

Phosphorus removal and recovery via struvite precipitation is applied at wastewater treatment plants, usually after a pre-treatment such as anaerobic digestion or even a combination of anaerobic digestion with an additional hydrolysis such as a thermal pressure hydrolysis or a thermal alkaline hydrolysis in order to increase the dissolved phosphate concentration. It is usually applied at wastewater treatment plant treating the wastewater of 100'000 population equivalents and more.

To enable struvite precipitation, a pH of 7.5 and higher is required. Hence, as a first step towards a higher pH, the CO_2 is stripped via air injection. In a second step, caustics are added such as NaOH, if the CO_2 stripping has not reached the required pH value. To induce struvite precipitation, together with a certain ammonium concentration, a magnesium source is usually added such as MgCl_2 , MgO or $\text{Mg}(\text{OH})_2$. Together with phosphate and ammonium, the magnesium forms struvite. This takes place in a reaction tank, the so called struvite reactor, which is typically a continuously stirred tank reactor. Crystal growth is promoted by mixing, sufficient retention time and recirculation of formed crystals. As a last step, the struvite in form of larger crystals is separated in a settling tank. Usually, the struvite is dewatered, dried and processed, before it can be applied as a slow-release fertiliser.

Variants of the process: sludge - liquor

If the CO_2 stripping and struvite precipitation take place in the sludge, the separation of the struvite crystals is less efficient and the crystals are usually inhomogeneous due to organic and/or inorganic impurities. However, the controlled struvite precipitation can be a useful measure to prevent pumps or pipes in the sludge line from scaling or even clogging (Desmidt et al. 2015).

If the CO_2 stripping and struvite precipitation take place in the liquor (e.g. after dewatering), the subsequent separation of the struvite is very efficient. However, the higher phosphate concentrations are, the lower the dewatering efficiency of the upstream dewatering unit is (Kuhn et al. 2013). Thus, the dewatering step might require more energy and sometimes even additives such as polymers in order to reach the required liquor quality. In the liquor, the crystals grow usually homogeneous. In NextGen the focus is on struvite production in the liquor, hence, the following sections will focus on this technological solution only.

The flow scheme and the pictures show an example for struvite production in the liquor (Figure 58, Figure 59). After CO_2 stripping, the struvite crystals precipitate in the struvite reactor as already described. Macro crystals settle down ready to leave the struvite reactor and micro crystals (struvite nuclei) are distributed in the liquor and enter the settling reactor. There, they can further grow and settle down. However, if they are still too small for settling, they are transported back to the struvite reactor. The hydrocyclone separates the small crystals from the liquor. They serve as struvite nuclei and lead to an improved crystal growth within the struvite reactor. The system of the reactors is very flexible, shown by the dotted lines that indicate an alternative way of operation.



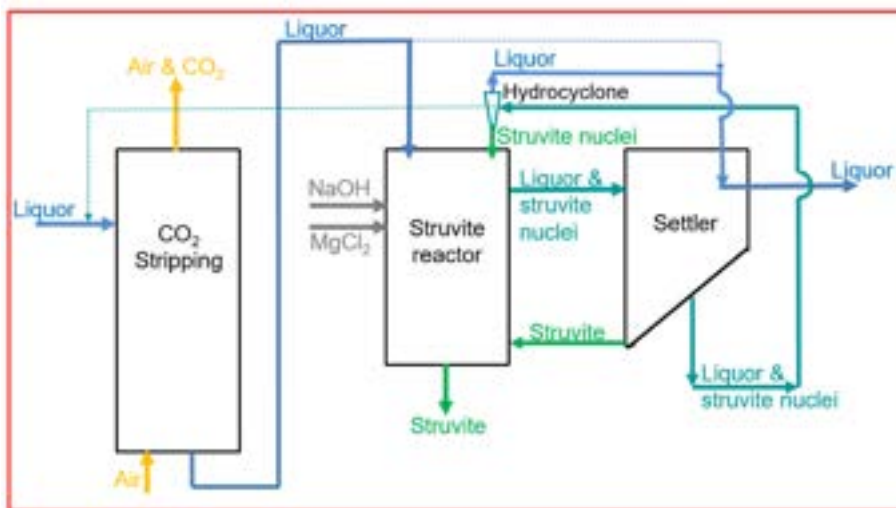

Figure 58 Flow scheme of the struvite production unit (NuReSys process)



Figure 59 Pictures of the struvite production unit consisting of a CO2 stripping unit, a struvite reactor, a settler and a container to collect the harvested struvite crystals (NuReSys process).

5.1.6 Requirements for the implementation of the technology and operating conditions

In the case study Braunschweig, three different technologies were implemented that are interconnected with each other:

- thermal pressure hydrolysis,
- struvite production and
- ammonium sulphate solution production via air stripping and gas scrubbing.

This chapter focuses on the struvite production unit.

In order to reach high struvite yields, the dissolved phosphate concentration in relation to the total phosphorus content should be as high as possible in the reactor influent. According to Cornel and Schaum (2009) concentrations of 50 mg PO₄-P/L are already economically rewarding. However, higher concentrations are preferred e.g. in Braunschweig, the concentrations in the influent to the reactor range between 250 and 500 mg PO₄-P/L. The total suspended solids (TSS) should be below 600 mg/L. Furthermore, ammonium and magnesium need to be present. Therefore, a molar ratio of Mg:N:P between 1:2:1 and 1:12:1 should be maintained in the reactor.



Table 64 Requirements and operating conditions for the struvite production unit

Parameter	Units	Min	Max	Reference
PO₄-P (influent to reactor)	mg/L	50 250	- 500	Cornel and Schaum (2009) Heinze (2022)
TSS (influent to reactor)	mg/L	<600		Heinze (2022)
pH (in reactor)	-	7.5	9	Heinze (2022), Cornel and Schaum (2009), Shaddel et al. (2019)
Mg:N:P molar ratio (in reactor)	-	1:12:1	1:2:1	Shaddel et al. (2019)

5.1.7 Results: struvite production

The struvite production unit was implemented and put into operation in autumn 2019. As Figure 60 shows, within the first year of operation, the phosphorus recovery rates were still below their expected minimum rate of 80%. Also, many downtimes of the plant occurred that are indicated by time periods without any data points. After one year of operation, the recovery rate started to increase and reached sometimes even its expected value at and above 80%.

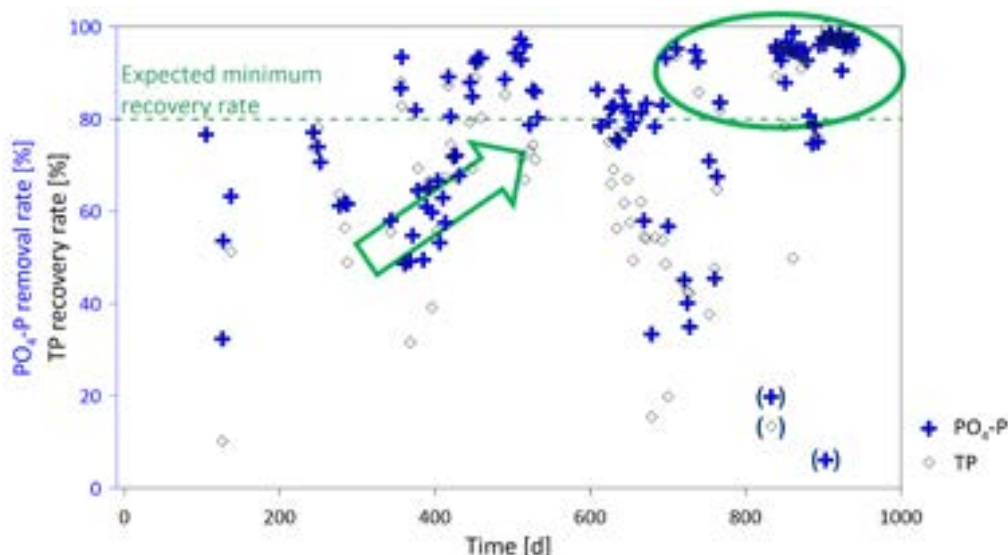

Figure 60 Phosphorus recovery rate referring to the total phosphorus (TP) and phosphate removal rate referring to dissolved phosphate (PO₄-P): The lower recovery rates referring to the total phosphorus compared to the higher removal rates of dissolved phosphate show the wash out of very small struvite crystals.

In summary, it took almost two years of optimisation of the process and the equipment until the process worked as expected and reliable high recovery rates were reached. Figure 60 shows two different rates. One rate refers to the phosphate removal rate and the other rate refers to the total phosphorus recovery rate. The phosphate removal rate indicates the successful precipitation process. Within the first two years, usually the phosphate recovery rate was higher than the total phosphorus recovery rate, indicating that more phosphate precipitated than it was recovered. Hence, very small crystals were washed out of the system and entered the subsequent ammonia recovery unit.

The reasons therefore were the too small size of the struvite crystals and an insufficient separation of the small crystals via the hydrocyclone. Consequently, the retention time of the



small crystals in the reactor was too short to allow the crystals to grow bigger. Different measures were investigated to increase the crystal size:

- The flow rate in the hydrocyclone was increased to better separate the fine crystals from the liquor.
- The geometry of the settler was changed and the slope of the declining reactor wall was increased to allow for better settling conditions of the small crystals
- Different MgCl_2 dosing rates were tested (Figure 61) to allow for a better crystal growth.
- The retention time of the crystals in the reactor was increased by a delayed harvest of the crystals. However, at the same time, a clogging event of the settler occurred.

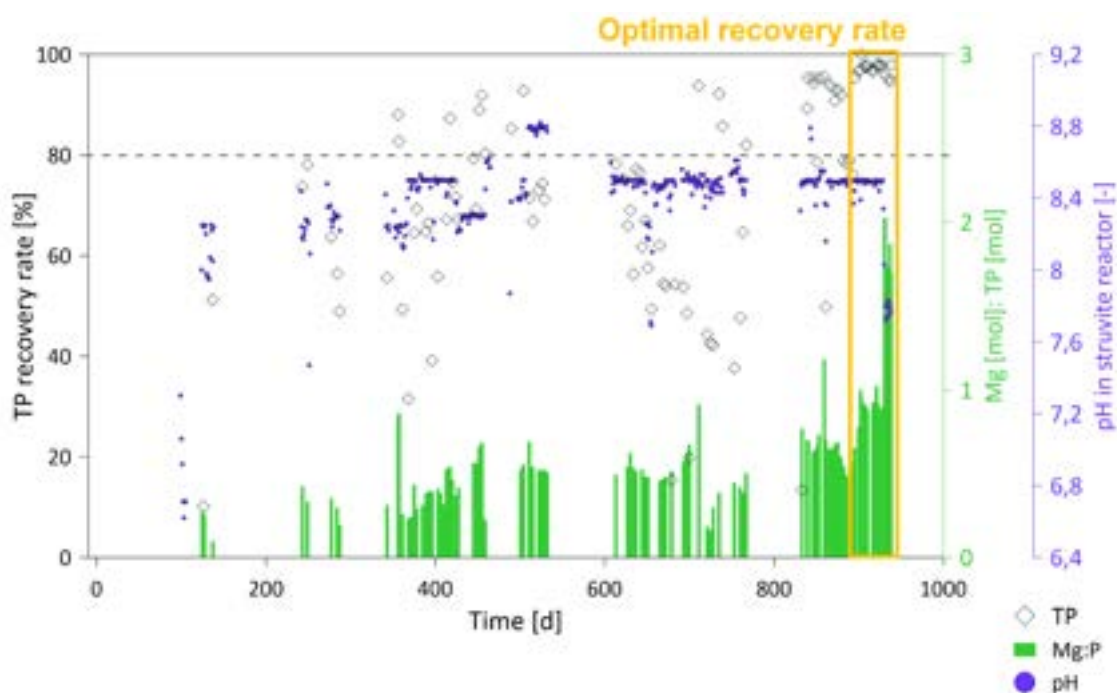

Figure 61 Phosphorus recovery rate referring to the total phosphorus (TP), pH and MgCl_2 dosing rate: after 900 days high recovery rates were reached with optimal operating conditions

After 900 days, the mixing conditions in the reactor were further optimised implementing an enlarged stirrer length and using a higher agitation speed. Furthermore, to extend the hydraulic retention time of the crystals, the small harvested crystals were reinjected in the reactor using an external vibrator and in the settler nozzles were exchanged to avoid any clogging. Simultaneously, the MgCl_2 -dosing was increased shown by the ratio of the magnesium to the total phosphorus (Figure 61). Using a high Mg:P molar ratio of around 2, resulted in a recovery rate above 80% at a lower pH of 7.8. In contrast to the high recovery rates during the days before, the pH was at 8.5 and the Mg:P ratio varied between 0.8 and 1.

As shown in Figure 62, the expected phosphorus recovery rate above 80% was always reached with a molar ratio for Mg:P > 0.8. However, the molar ratio of N:P did not reveal any correlation in its investigated range between 4 and 25. It mainly varied between 8 and 10. The chemical composition of the produced struvite showed contents of Ca, Na, K, Fe, S, Al, B, Mn and Co at levels that will allow the labelling only for the main nutrients P, Mg and N according to the German fertiliser regulation (DüMV 2012, Figure 63).

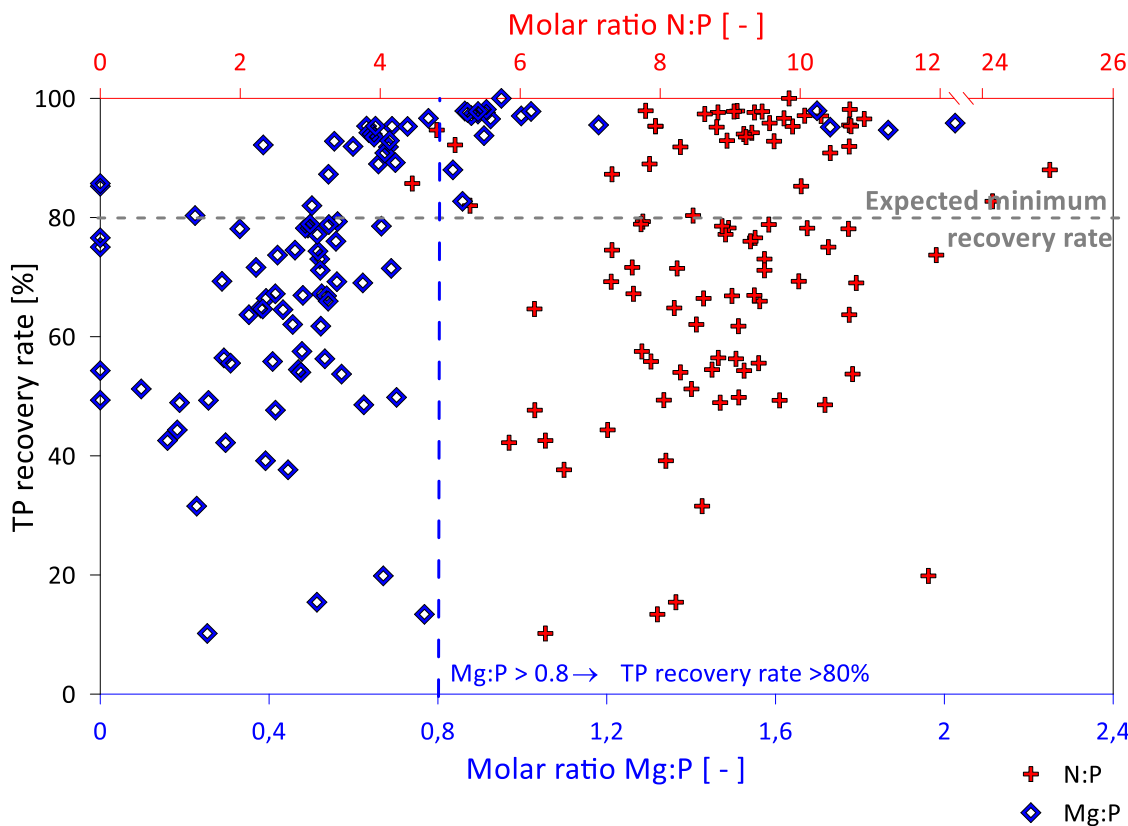

Figure 62 Case study Braunschweig: phosphorus recovery rates depending on the molar ratio of Mg:P: for Mg:P > 0.8 the expected recovery rates are always reached; no correlation observed for N:P

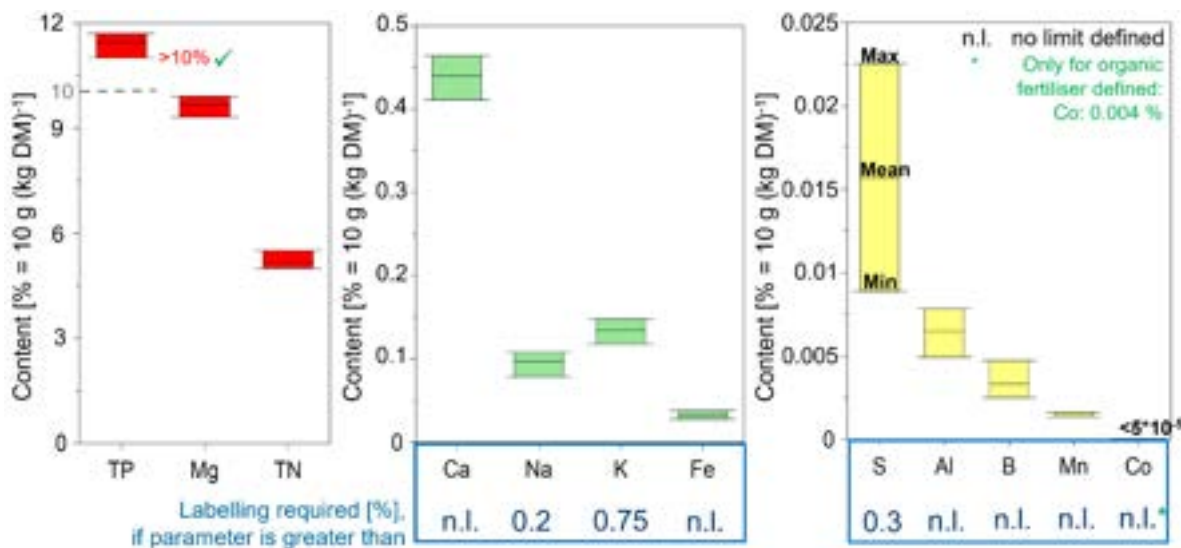

Figure 63 Chemical composition of the produced struvite of n=4 samples: the P content complies with the German fertiliser regulation (DüMV 2012) and labelling is only required for the main nutrients.

Furthermore, the P content is higher than 10% and complies with the German fertiliser regulation (DüMV 2012). The heavy metals contents are also far below the thresholds of the German fertiliser regulation (DüMV 2012) and even far below the value, for which a labelling is required (Figure 64). Thus, the produced struvite has a high quality. One further requirement of the German fertiliser regulation is however a grain size of smaller and equal



to 0.63 mm and 0.16 mm for 98% and 90% of the struvite crystals, respectively. Those sizes are much smaller than the grain sizes of the produced struvite ranging roughly between 0.5 and 2 mm. Hence, to promote better such technologies in Germany, the German fertiliser regulation should include a wider range grain sizes.

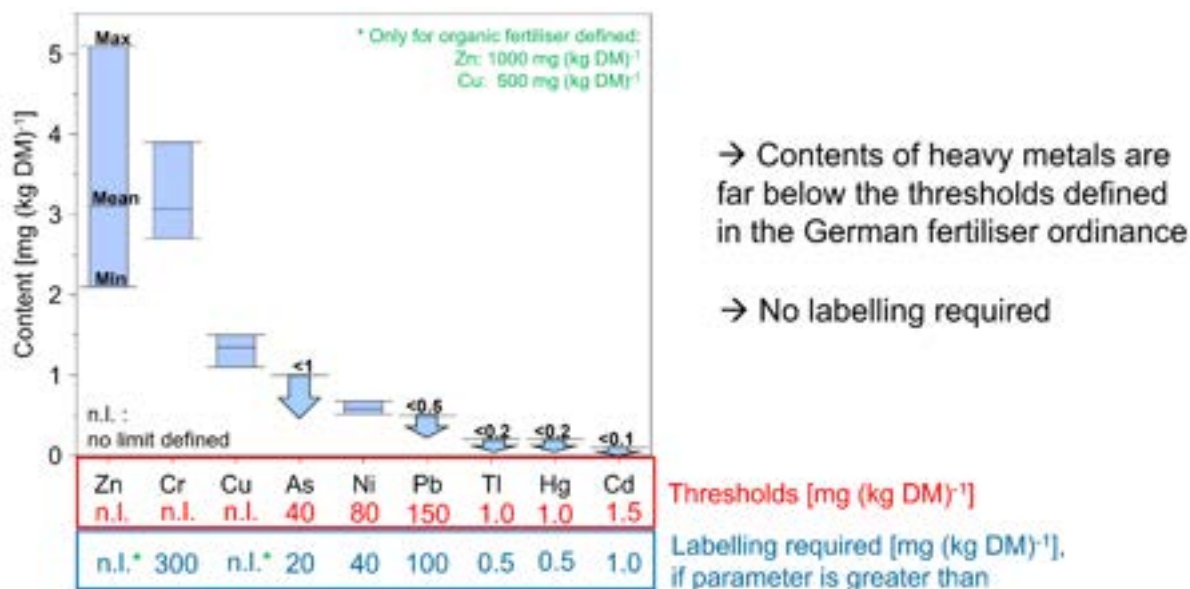

Figure 64 Contents of heavy metals in the produced struvite (n= 4 samples): according to the German fertiliser ordinance (DüMV 2012) no labelling of heavy metals are required, because the actual contents are far below the thresholds of the ordinance indicating a high quality of the product

Since Nov. 30th 2021, the European fertilising products regulation (EU 2021/2086) includes struvite that has been recovered from sewage sludge and wastewater. In the case of Braunschweig, however, the struvite will be used in the region, which is why in NextGen the German fertiliser regulation was considered. If the Fertilising Products Regulation shall be applied, additional parameters must be determined such as hexavalent chromium, biuret and perchlorate. For Zn, Cu, As, Ni, Pb, Hg, and Cd the thresholds are quite similar to those in the German fertiliser regulation and their actual content is far below their thresholds.

5.1.8 Comparison of the baseline situation and the NextGen KPIs

Before the implementation of NextGen in the baseline scenario, the phosphorus was eliminated from the wastewater via the enhanced biological phosphorus removal process and a chemical phosphorus removal process with FeClSO₄. This resulted in a phosphorus concentration in the effluent of the WWTP of 0.7 mg/L on average.

Due to the new struvite production plant, the phosphorus in the return load to the WWTP decreased and hence, the phosphorus concentration in the effluent was 0.6 mg/L on average in 2021, even though the struvite recovery plant was not permanent in operation (Table 65). Thus, with the struvite recovery plant in operation the legal requirement is easily fulfilled with a phosphorus concentration below 1 mg P/L in the effluent as required by the German wastewater directive (AbwV 2022).

Before NextGen, the phosphorus was reused in agriculture via the application of the sludge on the fields and via reusing the effluent for irrigation of the fields. Due to legal restrictions



regarding the application of digestate on the fields, its fraction decreased from 70% in 2019 to 60% with 2365 t/a on average for 2020 and 2021 (Table 65). Thereby, the remaining 30% and 40% were incinerated. However, since the implementation of the nutrient recovery units, the phosphorus is recovered via struvite in addition. Due to the optimisation phase of the process, the planned yearly rate of struvite production was not reached yet during a full year as shown in chapter 5.1.7. However, 300 t struvite/a are anticipated under optimised conditions and thus, 37 t P/a might be recovered in addition (Table 65). This corresponds to 16% of the influent phosphorus load to the WWTP.

Table 65 Crucial parameters to evaluate the phosphorus related processes after implementation of the NextGen technologies

Parameter		Units	Mean	Standard deviation	Number of measurements	Comments
Wastewater to the WWTP	Flowrate	m ³ /a	18.665.400	242.009	yearly average values of three years	2019-2021
Effluent from WWTP	Flowrate	m ³ /a	17.784.307	225.118		
Solids from WWTP to field	Massflow	t/a	2365	633	yearly average values of two years	2020-2021
Solids from WWTP to incineration	Massflow	t/a	1549	250		
Struvite production	Production rate	t/a	300	Optimisation of the processes is ongoing: estimated flowrate after optimisation phase of the nutrient recovery plant; actual recovery rate: 30% of expected rate		
Wastewater to the WWTP	TP	mg P /l	13.9	3	continuously measured	2021
	TKN	mg N /l	89	10		
	TSS	mg/L	439	125		
	COD _{hom}	mg/L	1009	151		
	COD _{filt}	mg/L	420	34		
Effluent from WWTP	TP	mg P /l	0.6	0.5		
	TKN	mg N /l	9.3	4		
	TSS	mg/L	7.2	5		
	COD _{hom}	mg/L	43	8		
	COD _{filt}	mg/L	37	5		
Struvite production	TP	g P /kg DM	115	3.1	4	
	TN	g N / kg DM	52	2.2		

Under optimised conditions, the performance of the struvite production unit was good and the phosphorus recovery rate reached its expected range above 80% as detailed outlined in chapter 5.1.7. A similar result was also obtained by Park et al. 2020, who used digested sludge filtrate as well and reached recovery rates between 83 and 91%. However, they used MgO instead of MgCl₂. The molar ratio of Mg:P was in a similar range between 0.6 and 1.5 at a pH between 8.25 and 8.5 as for the process in Braunschweig with 0.8 and 1 at a pH at 8.5. Rahman et al. (2014) compared 16 different struvite production plants obtaining phosphorus recovery rates mainly between 81 and 99% with Mg:P molar ratios mainly between 0.8 and 1.6 and at pH values ranging between 7 and 11. For the pH values below 8, used Mg:P molar ratios were between 1.2 and 2.4. Those observations correspond to the results from Braunschweig, where also at a lower pH of 7.8 in combination with a higher molar ratio Mg:P of around 2, phosphorus recovery rates of 97% were obtained.

As presented in chapter 5.1.7, the chemical composition of the struvite crystals showed extremely low heavy metals contents which were below their legal thresholds with factors between 5 (e.g. for TI and Hg) and 300 (for e.g. Pb) (see also Table 66). This observation is in



accordance with González et al. (2021) and Muy et al. (2021) who also showed lower heavy metal contents struvite compared to those in biosolids and lower contents than defined as limits in the European fertiliser regulation.

Table 66 Quality parameters of the struvite crystals

Parameter	Units	Mean	Standard deviation	Number of measurements	Comments
Struvite	Ca	4398	219	4	2021
	Na	972	127		
	S	156	62		
	Mg	96575	2528		
	K	1348	126		
	B	33	10		
	Co	<0,5	-		
	Fe	325	47		
	Al	65	12		
	Mn	15	1		
	As	<0.1	-		
	Pb	<0.5	-		
	Cd	<0.1	-		
	Cr	3.1	0.6		
	Cu	1.4	0.2		
	Ni	0.6	0.1		
	Ti	<0.2	-		
Zn	3.1	1.4			
Hg	<0.2	-			



5.1.9 Lessons learned

At the case study in Braunschweig, three different technologies were implemented, that are interconnected. The interaction of the single technical units is complex and has to be considered in the system design. The system design, the installation, system control and automation of the technological units worked well and only minimal optimisation was necessary.

However, as with many other innovative processes, numerous unexpected problems also occurred here, some of them were or are very time-consuming to deal with. Therefore, it is important to have employees who are open to new processes and that technology suppliers are available for a longer time period even after the commissioning of the system. In the following table, more details about the lessons learned from the design and operation of the struvite production unit are presented.

Required competence	
<p>An intensive training is needed to provide a knowledge that is far beyond the “standard” wastewater treatment knowledge such as:</p> <ul style="list-style-type: none"> • Chemistry and process engineering (especially: struvite formation) • Operation of a precipitation system <p>Due to the innovative technology, open minded and solution oriented personnel is beneficial to operate such a technology. A daily manual process control and maintenance is conducted during at least 2h/d at the moment and is expected to decrease in the future.</p>	



Maintenance	
<p>The struvite production unit is also a high-maintenance product. Under normal conditions the effort for maintenance and manual process control is 2 h/d. Due to unforeseen events such wash out of small struvite crystals and clogging of pipes, the effort increases above 2h/d.</p> <p>Twice a year extensive maintenance work is required lasting around one week. In this case, the following steps are required:</p> <ul style="list-style-type: none"> • Intensive investigation regarding wearing of plant components • Functional tests • Cleaning of plant components <p>For this work, usually external experts support the maintenance work. During the first three years of operation, the plant usually had two downtimes per month.</p>	
Technological risks	
<p>It is difficult to predict, how good the precipitation process will work for a certain feed stream quality. Furthermore, the crystal growth to a certain crystal size (e.g. 3 mm) can be difficult to control also depending on the feed stream quality.</p> <p>Correspondingly to the challenge of a controlled crystal growth, the risk of wash out of smaller crystals can occur and therefore, those small crystals can clog pipes.</p> <p>Thus, the commissioning time was and is still very long (already 3 years) in the case of Braunschweig.</p>	

Besides the lessons learned from the technology operation, we realised that depending on the fate of the produced struvite, knowledge on fertiliser marketing might be necessary. Otherwise, a cooperation with the fertilising industry might be beneficial.

5.1.10 Best practice guideline to design and operate the technology

Important aspects to consider during the design and construction of the plant:

- Suitable materials must be used for the system (corrosion resistant, etc.)
- Compliance with the country specific requirements for health and safety regarding the operation of the process (handling of chemicals, etc.)
- System should be flexible and adjustable (also accessible for retrofitting work) in order to increase the reaction time in the struvite reactor, to adjust the settling conditions of the crystals and/or to reinject small crystals in the reactor to allow for a longer growth time
- Pre-test is recommended to assess, if the wastewater composition is suitable for the precipitation process of struvite

Important aspects to consider during the start-up of the plant:

- The process water must be as free as possible of particles
- A functioning test is even recommended to be done with clean water



- The chemical composition of the process water should be as constant as possible and the flow rate should be sufficient high to run the process properly
- Sampling plan should be considered and the sampling documented

Crucial parameters for the optimisation of the production process:

- Chemical composition of the process water (phosphate and ammonium concentrations, TSS) and pH as shown in Table 67,
- The $MgCl_2$ dosing rate depends highly on the phosphorus concentration in the influent to the reactor and thus, the Mg:P molar ratio in the influent is crucial. Best results were obtained for $Mg:P > 0.8$ (see chapter 5.1.7)
- Rotational speed of the agitator in the struvite reactor: the best results were obtained in this case using a rotational speed between 1620 and 2700 rpm; however, this is very case specific.
- Hydraulic retention time of the crystals should be: in this case longer then 7d.

The indicated mixing conditions and retention time allowed for the best crystal growth during the presented investigations.

Table 67 Crucial operating parameters for the struvite production process: ranges for the best results

Parameter	Units	Min	Max
PO₄-P feed	mg/L	250	500
NH₄-N feed	mg/L	770	1800
TSS	mg/L	<600	
pH in reactor	-	8.5	
MgCl₂ dosing rate	L/(m ³ feed)	1.9	6
Mg:P molar ratio feed	-	0.8:1	2:1
HRT of crystals in reactor	d	>7	
Rotational speed in reactor	rpm	1620	2700



5.2 PK-fertiliser production in Altenrhein (CH)

Authors: Anders Nättorp (FHNW), Martin Schaub (CTU)

5.2.1 Description of the demo site

The WWTP of Altenrhein provides residential drainage-, wastewater- and sludge treatment of 17 municipalities in two federal states (St. Gallen and Appenzell-Ausserrhoden).

The treated water reaches Lake Constance via the mouth of the Old Rhine. Both Lake Constance and the Old Rhine are considered priority water bodies for protection. Lake Constance also serves as a drinking water reservoir. The topographical conditions around these 17 municipalities vary greatly which makes the water transportation more challenging. For this reason, special structures are required.

Sludge that is being treated in Altenrhein originates from their own water treatment and is also being transported to the site by other WWTP of Eastern Switzerland. The WWTP of Altenrhein (AVA) has advanced energy-efficient sludge management technologies for 300.000 PE of sludge: sludge is dried on site and is co-incinerated in cement works. The heat for sludge drying is generated by burning of sewage gas and by heat recovery from wastewater using heat pumps.

AVA took a full-scale removal of micropollutants by ozonation and active carbon adsorption into operation in 2019 and an ammonia membrane stripping unit from sludge dewatering employing an innovative membrane contactor with a novel low fouling membrane module in 2021. This represents a total investment of EUR 20 Mio in innovative technologies.

5.2.2 Motivation of implementing circular economy solutions in the water sector

After the project AVA will have a clear idea of the technical and financial feasibility of on-site activated carbon regeneration and production of fresh activated carbon using locally available sludge and biomass.

Long-term experience with full-scale installations for micropollutant removal and N recovery gained with the installations at Altenrhein will reduce investment risks, enhance chances of replicability.

AVA also gathers the all necessary information to take an investment decision regarding the construction of a PK-fertiliser production unit. This novel thermochemical process transforms sewage sludge into a market grade PK-fertiliser. Thereby heavy metals are partly removed and the fully plant available mineral phase CaKPO_4 is produced. The process has been piloted in a large-scale pilot to gain further operational experience.



5.2.3 Actions and case study objectives

Table 68 Action and case study objective of the PK-fertiliser production in Altenrhein

Case Study & Subtask	Technology baseline	NextGen intervention in circular economy for water sector	TRL	Capacity	Quantifiable target
#4 Altenrhein, Switzerland Sub-task 1.4.2	Incineration of the dried sludge at the cement factory	P recovery via pyrolysis as PK-fertiliser	TRL 5 → 7	Input: 20-50 kg/h	Phosphorus in sludge modified and purified for reuse as market grade PK-fertiliser

5.2.4 Unique selling points and benefits

The unique selling points for PK-fertiliser production are:

- ✓ Disposal and P recovery decentralised and possible for smaller amounts of sewage sludge
- ✓ Removal of contaminants due to the thermal treatment
- ✓ Output with high plant availability that can be sold as a fertiliser raw material

5.2.5 Principal and main characteristics of the technology

The Pyrophos® process jointly developed by FHNW, CTU AG, AVA Altenrhein, FiBL and Landor is a multi-stage thermochemical process for sewage sludge via fluidized bed pyrolysis with subsequent post-combustion (Schaub et al. 2019). It is suitable for wastewater treatment plants with a capacity of 100 000 population equivalents and greater. This corresponds to a loading rate of 1 t dry matter/h and higher.

Depending on the output requirements and availability, drained or dried sewage sludge, animal meal, animal meal ash or other phosphorus containing waste with low heavy metal pollution can be used as raw materials. The phosphorus containing raw materials are mixed with a potassium salt as an additive to improve the plant availability of the phosphates and fed into the reactor (Figure 65, Figure 66).

In the process, the heavy metals, which are volatile under reducing conditions, are partially expelled via the gas phase and retained in the exhaust gas cleaning system. At the same time, the thermal process converts the poorly soluble phosphates in the raw materials into potassium phosphates with a high solubility of over 80% in neutral ammonium citrate (NAC). Phosphoric acid can be used to stabilise the quality of the output. A post-combustion process produces ash containing potassium and phosphate, which can be processed into a multi-nutrient fertiliser (Figure 67).



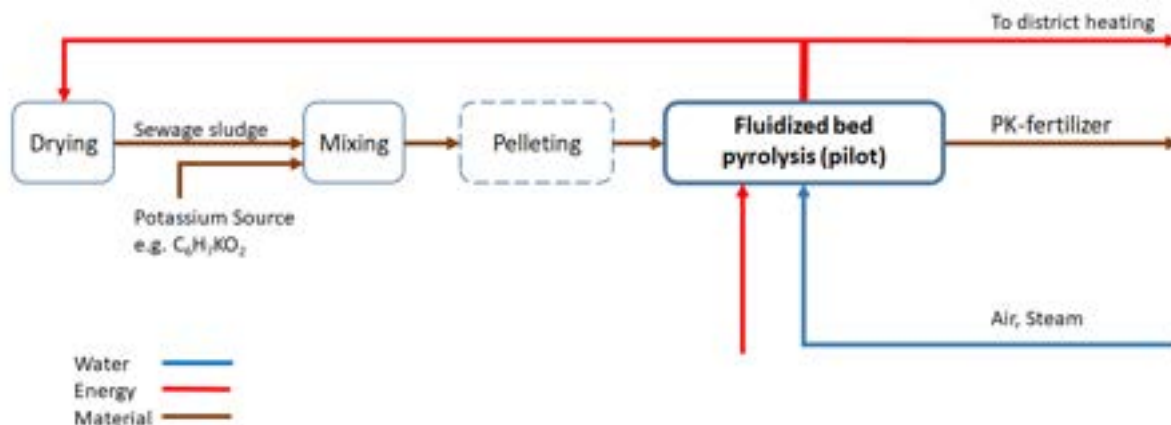

Figure 65 Flow scheme of the pilot plant for PK fertilizer production



Figure 66 Front and side view of the pilot unit (picture owner: CTU)



Figure 67 PK-fertiliser (picture owner: FHNW)

ASH-DEC and Euphore have developed similar processes for phosphorus recovery. Thermal treatment of sewage sludge and other phosphorus containing organic wastes generate heat and typically reduce the carbon content to less than 1% thus eliminating most organic pollutants. Heavy metals are partially eliminated by evaporation either in elemental form. By adding metal or hydrogen chlorides additional metals can be eliminated as volatile chlorides. Alternatively, alkaline metals can be added, modifying phosphate phases, and improving solubility and thus fertiliser plant availability.



5.2.6 Requirements for the implementation of the technology and operating conditions

The Pyrophos process requires a dry matter content in of at least 75% (Table 69). The temperature for the thermal treatment ranges between 700 °C and 1000 °C. Depending on the compositions of the sewage sludge, a maximum total phosphorus (P) content of 60 g/(kg DM) can be achieved. Potassium is added with a ratio between 2 and 4 kg K per kg P. Profitability strongly dependent on energy usage options at the location. Potential for cost reduction by using the heat recovery and exhaust air purification of an existing incineration plant.

Table 69 Operating conditions

Parameter	Units	Min	Max	Reference
Dry matter	%	75	-	Nättorp, Schaub (2020)
Temperature	°C	700	1000	Nättorp, Schaub (2020)
Potassium addition	kg K/(kg P)	2	4	Nättorp, Schaub (2020)

5.2.7 Results

The PK-fertiliser process of the case study Altenrhein was developed in a national project funded by Innosuisse. A pilot campaign in the frame of NextGen was prepared by the project partners, but had to be abandoned when the technology partner CTU decided to stop development activities in January 2021. Thus, the results summarised below are from this national project.

In the national project the process was tested in a pilot plant at 50 kg/h. A semi-industrial fuel preparation process was developed for mixing dry sewage sludge with the potassium source. In the reactor, both a reducing zone and a complete burnout by steam addition at the lower part of the fluidized bed were achieved. The product was granulated with good results. The contaminant content is below the limits of the European fertiliser products regulation but does not fulfil the more stringent Swiss regulation.

Future development will include better process control to achieve a relative plant efficiency of 90% (Figure 68). In the previous pilot tests 60% were achieved.

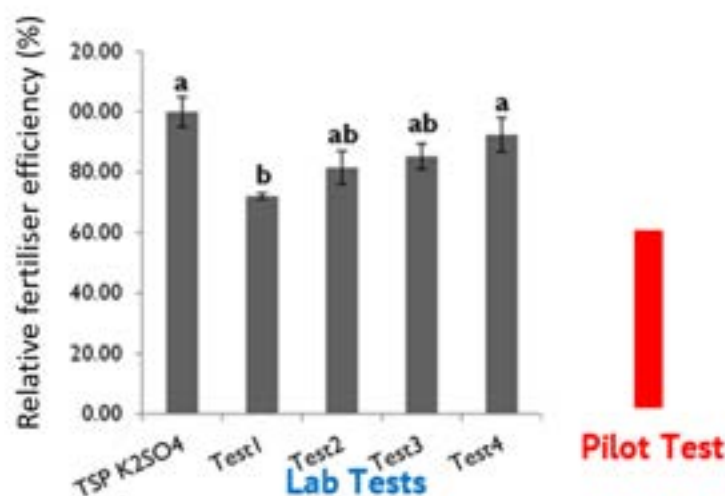

Figure 68 Plant availability of PK fertiliser from lab trials and pilot trial in 2020. Determination in pot test as relative fertiliser efficiency in comparison to triplesuperphosphate. Relative fertiliser efficiency (%)= (P absorbed from sample fertiliser – P adsorbed P₀)/ (P absorbed from TSP – P adsorbed P₀)x100



The product was diluted by bed material and this problem should be solved to have a good nutrient concentration. Furthermore, the treatment of meat and bone meal (MBM) should be tested. Lab trials in the frame of NextGen show that poorly available MBM phosphorus can be made available by this process. The temperature profile must be carefully controlled to keep the sintering of the MBM to a minimum.

CTU dimensioned plants for two scenarios for the NextGen cost and environmental assessments, both using the sludge composition of Altenrhein:

- Site Altenrhein: sludge volume of Altenrhein (7'500 t DM/a), co-processed with MBM ash (5'500 t/a) to achieve a product fulfilling the Swiss regulation
- EU: 40'000 t/a of dewatered sludge (10'000 t/a DM) in a completely new plant (LCC scenario) respectively as a modification of the Altenrhein setting (LCA).

5.2.8 Comparison of the baseline situation and the NextGen KPIs

Besides the P-recovery rate and the P and K contents of the PK-fertiliser, also the solubility in neutral ammonium citrate (NAC) is shown as a key performance indicator (Table 70). This solubility with the abbreviation P_{NAC} is an indication for agronomic effectiveness of the fertiliser in terms of phosphorus and a requirement of the European fertiliser products regulation.

Table 70 Comparison of NextGen with baseline situation via key performance indicators

Parameter	Units	Min	Max	Baseline	Reference
P-recovery rate of soluble phosphates (sludge)	%	90	100	0	Nättorp, A., M. Schaub (2020)
Plant availability of P in PK-fertiliser	%	60	100	100 (TSP)	Nättorp, A., M. Schaub (2020)
P content of PK-fertiliser	%	3	5	20 (TSP)	Nättorp, A., M. Schaub (2020)
K₂O content of PK-fertiliser	%	12	15	11-30	Nättorp, A., M. Schaub (2020)

The contaminants were measured during the pilot campaign in January 2020 (Table 71; Innosuisse national project). Since the process is not optimised, the composition will change. Notably, the concentration of P, K will increase and the elimination of some metals such as Zinc will improve.

Table 71 Example of contaminant profile of PK-fertiliser. Pooled samples from 4x0.5 t of input sludge and 1.5 t of products were produced. The sample was measured in triplicate. Measurements were compared between batches to validate results. Some variation in the range of +/-10%

Ca	mg/g DM	244
Na	mg/g DM	3
Mg	mg/g DM	6
K	mg/g DM	102
Fe	mg/g DM	55.5
Al	mg/g DM	35.1



As	mg/g DM	0.01
Pb	mg/g DM	0.01
Cd	mg/g DM	0.00
Cr	mg/g DM	0.07
Cu	mg/g DM	0.30
Ni	mg/g DM	0.03
Zn	mg/g DM	0.80
Hg	mg/g DM	<0.00005

5.2.9 Lessons learned

Required competence	
<p>The operating manager shall have experience with running combustion or gasification plants. For the other operators, it is certainly of advantage with a base training as either:</p> <ul style="list-style-type: none"> • mechanic • electrician • chemical plant operator <p>For helpers, no specific background is required. Certainly, it is important to train:</p> <ul style="list-style-type: none"> • Safety, health, environment (SHE) • Specific training on the control system • Specific training on plant answers (what happens, if...) • Specific training on start-up / shut down • Specific training on maintenance 	
Maintenance	
<p>There is one maintenance planned per year for a time of 3 to 4 weeks In addition regular maintenance for specific equipment (lubrication etc.) to be done during normal operation. 24/24 operating supervision is required in the beginning, which may be reduced to 2days/shift after 2 years operation with temporary support upon automatic calling. For some equipment and instruments maintenance must be performed by experts.</p>	
Technological risks	
<p>Downtimes will occur mainly for failures of instruments and/or clogging of solids conveying systems. It is less likely, that downtimes occur due to fouling if yearly maintenance is carried out correctly. It must be assumed, that there will be 3 to 4 downtimes per year lasting for more than a few hours. We assume usual downtimes to be below 12 hours. We expect equipment failure 3 to 4 times per year. The downtime may last several days depending on availability of spare parts. No experts are needed to restart after downtime. Good maintenance, good management of operation interpreting trends and results of operation are all ways to minimise downtime.</p>	



5.2.10 Best practice guideline to design and operate the technology

Good quality of mechanical and electrical erection is important for construction as well as correct placement of instrumentation.

Start-up of the plant needs support by the process owner and needs involvement of the (future) operating staff. Usually operating staff already runs the plant, while the process owner instructs the staff.

Operating parameters to be considered:

- K/P ratio in feed stream to pyrolyser/ gasifier
- temperature in fluidised bed
- CO concentration in fluidised bed synthesis gas

The temperature of the gasification and the atmosphere (slightly reducing) need to be closely monitored as well as the ratio K/P. Adjustment to be made upon results of product tests (availability of P/K for the plants).



5.3 Hydroxyapatite production in Spenal (UK)

Authors: Ana Soares (UCRAN) and Peter Vale (Severn Trent)

5.3.1 Description of the demo site

Spenal wastewater treatment plant (WWTP) is a medium sized plant serving the towns of Redditch and Studley located approximately 24 km south of Birmingham (UK) (Figure 69). The site has a dry weather flow of 1'150 m³/h (or 27'6000 m³/day) serving 92'000 population equivalent. Spenal WWTP includes a preliminary treatment, primary treatment, an activated sludge plant, secondary clarifiers, and sand filters. The treated effluent is discharged to the River Arrow, which is designated as a sensitive area under the Urban Wastewater Treatment Directive (UWWTD) and has an overall water body status of moderate under the Water Framework Directive (WFD). The sludge produced on site, and other local rural works, is further treated in anaerobic digesters and dewatered before being recycled to local farmland and industries. The biogas produced by digesters is burnt in combined heat and power (CHP) engines to produce heat and electricity.



Figure 69 Location of the Spenal wastewater treatment plant (WWTP) within the United Kingdom (left) and local map (right).

Spenal serves as Severn Trent Water's "Urban Strategy Demonstration Site" where emerging technologies compatible with low energy demand, low greenhouse gas emissions and a circular economy approach are being evaluated (Figure 70). The "Urban Strategy Demonstration Site" contains all the infrastructure; power, wastewater feed, drainage, telemetry and biogas handling equipment necessary for the NextGen trials, together with office and laboratory facilities. Among the technologies tested is a multi-stream demonstration scale anaerobic wastewater treatment plant for carbon management and ion exchange processes for nutrient management (Figure 71). The demonstration plant incorporates an anaerobic membrane bioreactor (AnMBR) complete with a membrane degassing unit to recover dissolved methane. AnMBR combines several benefits such as: no aeration energy for removal of COD/BOD, low sludge production and associated treatment efforts, biogas production (production of electricity/heat), pathogen and solids free effluent which can be re-used in several applications (e.g.: farming and industrial use). The ion exchange (IEX) process enables targeted ammonia (N) and phosphorus (P) removal and recovery to produce a high quality effluent whilst recovering calcium phosphate salts and ammonia sulphate solutions.





Figure 70 Aerial picture showing the Urban Strategy Demonstration Site at Sernal WWTP and the location where the NextGen demonstrator was built

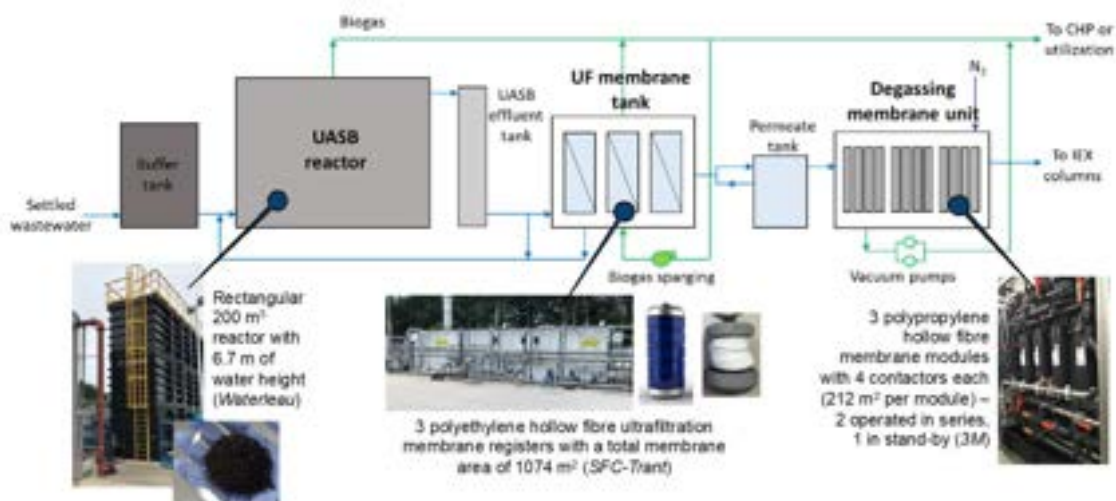

Figure 71 Aerial picture showing the NEXT-GEN demonstrator including the anaerobic membrane reactor and degassing unit (top) and the schematic representation of the process (bottom).

The data gathered at the Sernal WWTP innovative technology flowsheet aims to demonstrate and showcase the viability of this transformative approach to wastewater



treatment in cold- climate northern European countries, enabling a future of energy recovery combined with effective recovery of nutrients. The project confirms the optimal design and operating parameters to deliver a comprehensive energy balance and cost benefit assessment.

5.3.2 Motivation of implementing circular economy solutions in the water sector

The water sector is a relatively large user of energy and a significant emitter of fugitive greenhouse gases (nitrous oxide and methane) it is therefore incumbent on water utilities to address the challenge of climate change by striving to reduce its carbon footprint. Transitioning to a more circular way of operating; reducing the amount of energy and chemicals required in treating water and recovering and reusing the energy, materials and water that is plentiful in wastewater will become a central strategy of water utilities. The AnMBR/ion exchange flowsheet, once proven, can deliver an energy neutral wastewater treatment process, reduce process emissions by removing the main contributor to nitrous emissions – biological nitrification and denitrification and facilitate resource recovery through producing a solids free disinfected effluent ideal for nutrient (N and P) recovery and/or the recovery of water and nutrients through fertigation.

5.3.3 Actions and case study objectives

Table 72 Action and case study objective for phosphorus recovery in Spernal

Case Study & Subtask	Technology baseline	NextGen intervention in circular economy for water sector	TRL	Capacity	Quantifiable target
#5 Spernal, United Kingdom Sub-task 1.4.5	Spernal wastewater treatment plant serves as Severn Trent Water’s “Urban Strategy Demonstration Site”	Nutrient recovery via adsorption / ion exchange (IEX): P removal (hybrid anion exchange (HAIX) column) & P recovery (addition of CaOH to the spent regenerant).	TRL 6 → 7	10 m ³ /d nutrient stripped effluent	Hydroxyapatite is precipitated. The regenerant is re-used.

5.3.4 Unique selling points and benefits

Ion exchange (IEX) for nutrient ammonia and phosphorus removal and recovery and the hollow fibre membrane contactor (HFMC):

- ✓ High recovery rates: up to 95% of ammonia and 90% of phosphorous
- ✓ High product water quality which can be used in the chemical and fertiliser industry
- ✓ Low energy consumption
- ✓ Simple equipment and low maintenance cost
- ✓ Compact system with very small footprint
- ✓ No sludge production



- ✓ No start-up period required (can be switched on or off on demand)
- ✓ Low chemical consumption due to regenerants restoration and re-use

5.3.5 Principal and main characteristics of the technology

The IEX process for phosphorus removal from wastewater used a synthetic hybrid anion exchanger (HAIX) resin: a polymeric base, where amorphous iron hydroxide nanoparticles (HFO-NP) have been dispersed. Two processes take place within the HAIX: the exchange of anions (Cl^- , SO_4^-) between the polymeric base and the liquid phase and the adsorption of phosphorus (as divalent anion HPO_4^{2-} and monovalent anion H_2PO_4^- onto the HFO-NP via Lewis acid interactions. HAIX has been used to efficiently remove phosphorus from phosphorus rich streams (including urine, municipal wastewater, surface waters, sludge dewatering liquors) but mostly in lab conditions and only recently its feasibility was shown at Cranfield University as a tertiary treatment process (Figure 72).

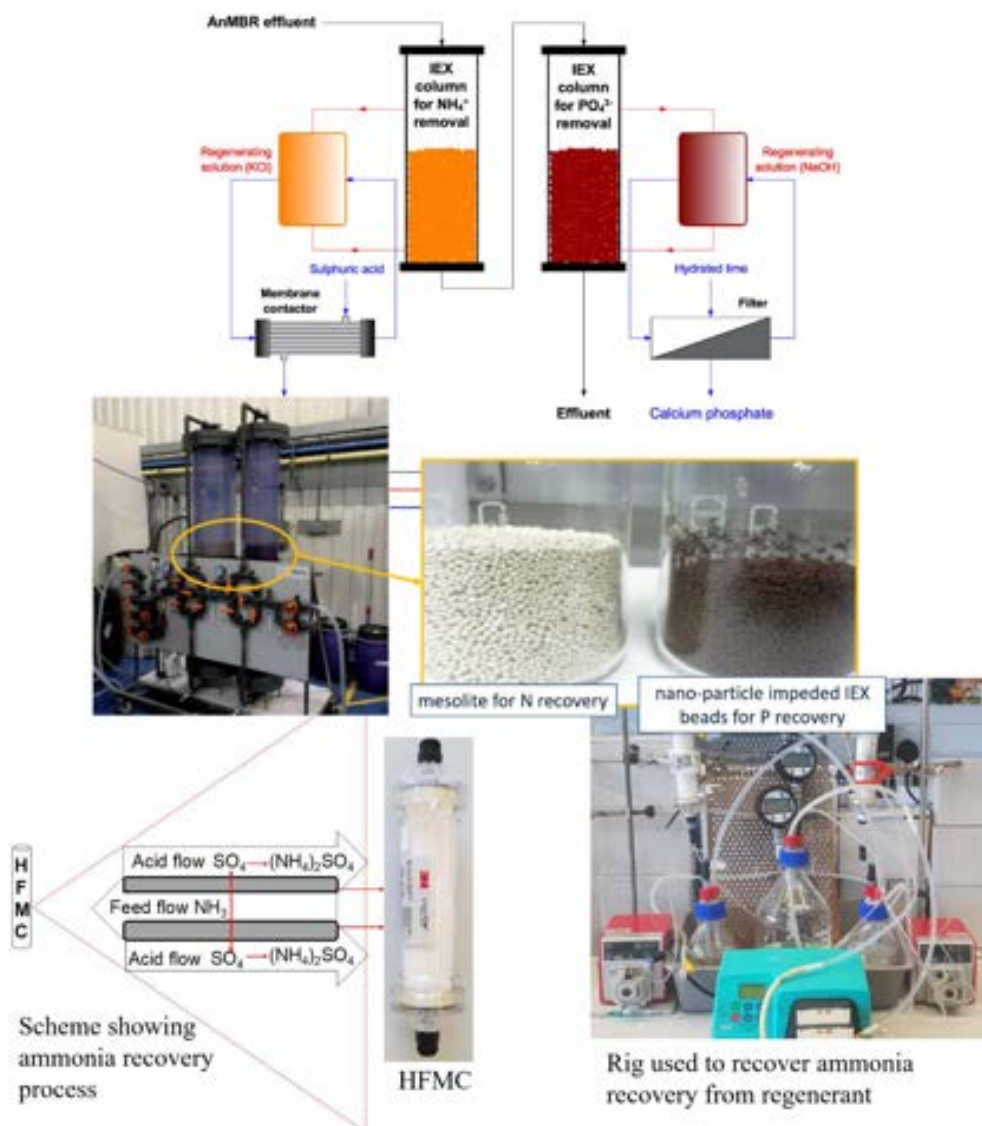

Figure 72 Schematic representation of the ion exchange plant for ammonia and phosphorus removal and recovery (top) and pictures of the technology at Cranfield University (middle) and ammonia recovery technology (bottom)



The components of the demonstration plant IEX include a compressed air diaphragm pump (same pump used for IEX for ammonia removal), storage tank for the regeneration chemical, 1 IEX column of hybrid anion exchanger for phosphorous removal with 14 L of HAIX to have an empty bed contact time of 20 minutes. Shorter empty bed compact times would be possible with this technology (5 min for P removal), but the operation was limited to a volume of anMBR effluent that could be transported and stored, at around 1 m³/day over 5 days a week. This was related with restrictions at Sperial WWTP to house the IEX demonstration plant, as an alternative this was located at the Cranfield University UKCRIC National Research Facility for Water and Wastewater Treatment. The entire demonstration plant was assembled on a steel rack. The ion exchange media was regenerated when the desired effluent concentration was reached. The regenerant was 2% NaOH solution and phosphorus was recovered from the saturated regenerant. For P recovery, PO₄³⁻ is produced in the form of calcium phosphate, Ca₅(PO₄)₃OH using a hydroxyapatite production system with the addition of hydrated lime to the NaOH regenerant.

5.3.6 Requirements for the implementation of the technology and operating conditions

It is required to have nearly no solids and low organic matter. This is because solids will cause plugging in IEX columns and elevated organic matter concentration can cause biological fouling of the media. Full technology requirements are described in Table 73.

Table 73 Required operating conditions of the IEX process for nutrient removal and recovery

Technology	Parameter		Units	Mean	Reference
Ion exchange	IEX Influent	Flow rate	m ³ /d	1-10*	Own data
		Temperature	°C	4-25	
	IEX Effluent	Flow rate	m ³ /d	1-10*	
		Temperature	°C	4-25	
Hydroxyapatite production system	Regenerant PO ₄ -P		mg/L	500-1000	
	Ca:P ratio		-	1.5-4	
	P recovery rate		%	95	
	CaOH consumption		t/a	0.4	

* flow matches the IEX design for this specific project, very simple to upscale to higher flows

5.3.7 Results

The influent PO₄-P concentration to the IEX was 6.3 ± 0.55 mg PO₄-P/L (Figure 73). The first 650 BV operation aimed to reach saturation as far as possible. The peak C/C₀ ratio was 0.8 and the adsorption capacity was 3.5 mg PO₄-P/g media. Then the first regeneration was conducted.

The effluent PO₄-P concentrations were mainly below 1 mg P/L and the removal efficiency was 80%. When looking at the shape of the curve of the effluent PO₄-P concentration after regeneration, it is possible to see that concentration took some BV to stabilise, this was likely due to poor rising of the regenerant in between cycles. The IEX process was oversized (i.e., the IEX column had a very large size and capacity, as it was designed to process at least 10



times the used influent flow here used, limited to 1 m³/day). Only 1 m³/day anMBR effluent could be transported from Sernal to Cranfield due to transporting company requirements and restricted storage space on both sites (a fact that only came to light at the very start of the tests), nevertheless the IEX design was made for 10 m³/day of anMBR effluent. As such, the IEX column was large and not rinsed properly with only 1 BV of water after regeneration. This led to high ammonia concentrations left in the column walls and still around the media after regeneration and that it took some bed volumes of operation with wastewater to be completely washed away and ammonia adsorption to be recorded. Nevertheless, the process was efficient and high phosphate removal was achieved.

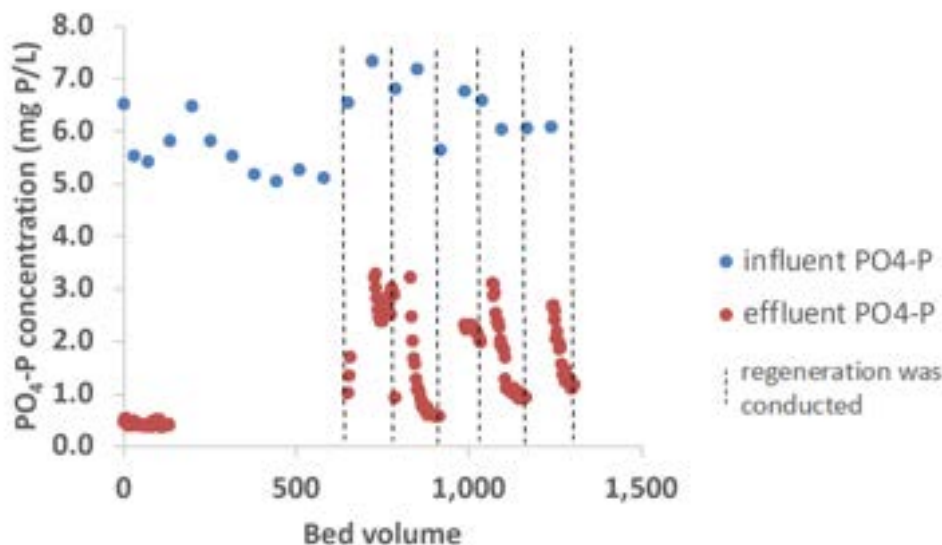

Figure 73 Influent and effluent PO₄-P concentrations during operation of IEX demonstration plant.

The phosphate exchange capacity obtained was similar to previous studies completed at a range of scales and also with secondary effluents origination from trickling filters (Table 74).

Table 74 IEX media for phosphate removal and exchange capacity from other studies

Bench test / pilot plant	IEX media	Phosphate exchange capacity	Regenerants used	Reference
Bench scale	Hybrid anion exchanger Layne	4.1±0.4 mg P/g	2% NaOH	(Pinelli et al. 2022)
10 m ³ /d, demo plant using trickling filter effluent from WWTP	Hybrid anion exchanger Layne	4.1 mg P/g	2% NaOH	(Guida, et al. 2021)
Bench test using secondary WW effluent	Hybrid anion exchanger Layne	7.0-9.7 mg P /g	4% NaOH	(Muhammad et al. 2019)

The regenerant accumulated mild concentrations of phosphate (Table 75). The regeneration efficiency showed a decreasing trend from 1st to 3rd regeneration cycle, and the PO₄-P



concentration in regenerant levelled off since the 3rd regeneration. These are results were surprising as Guida et al. 2021 achieved a much higher PO₄-P concentration of 785 mg P/L after 8 regenerations and the data was reproduced over many cycles. It suspected that the oversize of the demonstration plant in NextGen results in poor mass transfer between the media, the wastewater and regenerant, yielding these odd results.

Table 75 Phosphate concentrations in regenerant at the end of each regeneration

Regeneration cycle	PO ₄ -P concentration in regenerant (mg P/L)
1 st (end)	150
2 nd (end)	185
3 rd (end)	190
4 th (end)*	200
5 th (end)	195
6 th (end)	185

*regenerant loses efficacy and it is recommended that recovered regenerant is used after 3-4 cycles

Nevertheless, the phosphate could be recovered from the regenerant. The addition of Ca(OH)₂ to a molar Ca:P ratio of 3 allowed for the recovery of 98% of the mass of PO₄-P. The concentration of phosphate in the NaOH regenerant decreased to 4.2 mg PO₄-P/L (after 24 h). The mixing of the two liquid streams results in the instant formation calcium phosphate. The scanning electron microscope (SEM) analysis revealed an amorphous crystal structure and the EDX indicated a composition of 5.7% P, 15.1% Ca (in weight %). The XRD analysis showed that the recovered precipitate was similar to hydroxyapatite (Ca₁₀(PO₄)₆(OH)₂) as shown by the comparison against the standard from literature. The recovered hydroxyapatite was also analysed for impurities that showed no pathogens (total coliforms and *Escherichia coli* <0 cfu/g), low concentrations of metals and the investigated organic pollutants were below the detection limits (Table 76). It is estimated that 7-10 kg of dried product can be recovered per year, a 1 m³/d plant.

Table 76 Pathogens, metals and organics analysis of hydroxyapatite recovered from saturated regenerant

Impurity	Concentration	
	Unit	Value
Total Coliform presump	cfu/kg	0
Total Coliforms confirmed	cfu/kg	0
<i>E.coli</i> presumptive	cfu/kg	0
<i>Escherichia coli</i> confirmed	cfu/kg	0
Aluminium, Filtered as Al	mg/kg	<0.0004
Cadmium, Filtered as Cd	mg/kg	<0.0000024
Chromium, Filtered as Cr	mg/kg	0.000008
Copper, Filtered as Cu	mg/kg	<0.000036
Iron, Filtered as Fe	mg/kg	<0.00092
Lead, Filtered as Pb	mg/kg	<0.000024
Mercury, Filtered as Hg	mg/kg	<0.0000004
Nickel, Filtered as Ni	mg/kg	<0.000012
Potassium, Filtered as K	mg/kg	<0.00072
Zinc, Filtered as Zn	mg/kg	<0.000072
Arsenic, trace Filtered as As	µg/kg	<0.004



5.3.8 Comparison of the baseline situation and the NextGen KPIs

The existing Sernal WWTP constitutes the base case to provide a comparison to the Nextgen Sernal demonstrators. The base case is shown in (Table 77):

Table 77 Base case: Sernal WWTP flow rates, standard influent and effluent parameters

Parameter	Units	Mean value	Standard deviation	Frequency of the measures	Summer mean value	Standard deviation	Winter mean value	Standard deviation	Considered years for the analysis
Influent									
Flowrate	m ³ /h	1267	447	Daily	1114	344	1422	484	2018
Effluent									
Flowrate	m ³ /h	1097	324.7	Daily	921.4	195.8	128	330.7	2018
Influent to the Sernal WWTP									
COD	mg O ₂ /L	861.2	520.8	Twice per month	947.7	604.5	759	405.1	2018
BOD ₅	mg O ₂ /L	276.1	172.3	Twice per month	322.7	192.8	221.1	132.3	2018
TSS	mg/L	515.2	300.6	Twice per month	536.9	358.3	489.6	228.9	2018
TN	mg N/L	32.6	7.1	twice per month	34.7	4.3	30	9	2018
NH4-N	mg N/L	31.0	8.2	Twice per month	34.2	4.6	27.2	10.0	2018
TP	mg P/L	7.5	3.3	Twice per month	8.46	3.5	6.3	2.9	2018
Effluent from the Sernal WWTP									
COD	mg O ₂ /L	44.6	11.5	Twice per month	43.69	11.1	45.7	12.4	2018
BOD ₅	mg O ₂ /L	3.6	2.7	Twice per month	4.2	2.7	2.9	2.6	2018
TSS	mg/L	9.8	6.9	Twice per month	7.2	3.6	12.8	8.6	2018
TN	mg N/L	34.5	5.2	Twice per month	34.1	5.6	35.0	4.9	2018
NH4-N	mg N/L	2.4	1.1	Twice per month	2.0	1.0	2.8	1.1	2018
TP	mg P/L	1.2	0.3	Twice per month	1.2	0.3	1.1	0.3	2018

The Sernal WWTP is a medium sized plant and treats an average daily flow of 27 ML/d to a 10 mg BOD/L, 25 mg TSS/L, 5 to 10 mg NH₄-N/L and 2 mg P/L standard. The plant includes a preliminary treatment (6 mm screening and grit removal), conventional primary settlement tanks with iron dosing for P removal, secondary treatment comprising of trickling filters for 33% of the flow and activated sludge for the remainder and tertiary sand filters.

Effluent from the plant presents COD of 44.6 ± 11.5 mg/L, BOD of 3.6 ± 2.7 mg/L, total suspended solids (TSS) of 9.8 ± 6.8 mg/L; a total nitrogen (TN) content of 34.5 ± 5.18 mg/L, and a total phosphorous (TP) of 1.18 ± 0.3 mg/L. In this case, the quantity of microorganisms for both influent and effluent is not shown as it is not measured regularly. The overall quality of both influent and effluent is better during the winter period.

In addition, the effluent from Sernal base case is defined in Table 78, and compared with the effluent from the combined NextGen technologies tested, i.e., the effluent from the IEX system.

Table 78 Effluent quality – potential water for re-use produced in the base case and NextGen



Parameter		Units	Mean value	Standard deviation	Frequency of the measures
Base case Influent	Flowrate	m ³ /h	1267	447	Daily
Base case Effluent	Flowrate	m ³ /h	1097	324.7	Daily
Effluent from the Sernal WWTP	COD	mg O ₂ /L	44.6	11.5	Twice per month
	BOD ₅	mg O ₂ /L	3.6	2.7	Twice per month
	TSS	mg/L	9.8	6.9	Twice per month
	TN	mg N/L	34.5	5.2	Twice per month
	NH ₄ -N	mg N/L	2.4	1.1	Twice per month
	TP	mg P /L	1.2	0.3	Twice per month
Effluent from NextGen (after all processes including IEX)	COD	mg O ₂ /L	Still being determined but <50	19	Daily
	BOD ₅	mg O ₂ /L	Still being determined but <25	10	Daily
	TSS	mg/L	< 1		Daily
	TN	mg N/L	< 1		Daily
	NH ₄ -N	mg N/L	< 2		Daily
	TP	mg P /L	< 1		Daily
	<i>E.coli</i>	CFU/100 mL	Still being determined but <3350		Monthly
	Total Coliform	CFU/100 mL	Still being determined but <8700		Monthly
Faecal Coliform	CFU/100 mL	Still being determined but <4600		Monthly	

No products are recovered yet at the base case in Sernal at the full-scale treatment plant with activated sludge as secondary treatment process.

However, according to the lab-scale investigations, 0.5 kg hydroxyapatite/d with an influent flow rate of 500 m³/d are expected to be produced. This corresponds roughly to 9.1 t Ca₁₀(PO₄)₆(OH)₂/a (i.e., 0.28 t P/a) that might be expected from a full-scale plant (100 000 PE). The quality of the recovered hydroxyapatite can be found in Table 76.



5.3.9 Lessons learned

Required competence	
<p>The ion exchange and phosphorus recovery units are new technologies for the water sector with a complex operation. Knowledge of the specific operation and maintenance procedures are necessary.</p>	
Maintenance	
<p>The frequency of plant maintenance per month comprises roughly two days. The duration of a normal maintenance procedure is 2h and the duration of active process control per day (manual process control, unforeseen events) is roughly 1 h. No external experts are required to conduct the maintenance procedure.</p>	
Technological risks	
<p>A reason for a downtime might be, that the effluent quality is not maintained by frequent regenerations, because it is missed due to spot sampling alone. However, plant downtimes have not been observed so far.</p> <p>A measure to avoid such a downtime is having a full automated plant with online sensors, which trigger regenerations.</p>	

5.3.10 Best practice guideline to design and operate the technology

Important to consider during the construction of the plant:

- process has a bespoke design,
- understanding of contact times,
- availability of IEX media and
- health and safety related aspects of chemical storage

Crucial for the start-up of the plant is an operator training for a good process understanding.

Parameters that are crucial for the optimisation of the production process:

- empty bed contact times,
- regeneration frequency,
- product recovery routines
- recover regenerants achieving a low chemical input process

The ranges for those to gain the best removal and production results still need to be clarified via a full plant automation with the required sensors.



6. Dynamic sewer modelling: impact of low-flow local wastewater on nutrient concentrations

Authors: JungEun Kim (UBATH), Ana Lanham (UBATH), Jan Hofman (UBATH)

6.1 Description of the demo site

The Filton Airfield site was purchased in 2015 by and slated for development by YTL Development UK Ltd, a subsidiary of the multinational YTL Corporation. The £800 million scheme, a new suburb to be named Brabazon, will comprise more than 2675 new homes and 62 acres of commercial space, as well as new schools, recreation spaces and health facilities (Figure 74). As the parent company of Wessex Water, YTL is set to place significant focus on the development's water management capability and is working with the University of Bath's Water Innovation and Research Centre (WIRC) to investigate and implement the waste-minimising circular economy practices it will need to appeal to planners and future residents. The large size of the development presents a unique opportunity to fully demonstrate and test these practices.



Figure 74 Location of Filton Airfield and Filton Airfield master plan

Within NextGen, local recovery and reuse of nutrients are one of the key ideas to increase sustainability and circularity in Filton Airfield. In this demo case study, two strategies are considered. The first one is that a new sewer design can be used that transports wastewater at a lower water content which will enhance nutrient contents in wastewater and thus recovery efficiency. In recent times and into the future, sewer networks are being designed as separate sewer systems, where there are two different pipes for stormwater and wastewater. However, a lot of the existing sewer networks are not designed in this way and as urban areas expand and connections are made to the existing networks, water consumption must be reduced to alleviate the pressure on these existing networks (i.e., a combined sewer network system). Another strategy is to use water-saving appliances including waterless washing machines, water-saving shower heads and low-flush toilets. The Filton demo case demonstrates the impact of local water use on nutrient concentrations by limiting the amount of water entering the sewer network system (i.e., the use of a separate sewer system that carries only wastewater discharged from homes).

6.2 Motivation of implementing circular economy solutions in the water sector

Since Filton Airfield is under development and available local data is limited, modelling and prediction of local nutrient recovery is necessary. In other words, the availability of local nutrients that can be recovered from wastewater at Filton Airfield Development needs to be identified. This will draw outcomes that can be served as a significant step towards an integrated nutrient management strategy to head to a more sustainable application of nutrients and stimulate the markets for recovered nutrients. In this context, we have introduced two strategies (explained in Section 6.1) and they are aligned with the research priorities of the developer (YTL), in particular, “sustainable urban development and improvement of self-sufficiency”. As a result, urban wastewater management and resource recovery potential demonstrated during the project will encourage other authorities and organisations to follow YTL.

6.3 Actions and case study objectives

Table 79 shows the main task and describes the applied circular economy concept of the material cycle. This specific case study explored the quantitative analysis of nutrient concentrations within the selected Brabazon housing area (113 housing units) and the specific tasks are as follows:

- Produce a stochastic model of water discharge patterns and nutrient concentrations using a combination of the SIMDEUM tool (Blokker et al. 2017) calibrated to the UK population and the Storm Water Management Model (SWMM) (Gironás et al. 2010)
- Use the model to test the effect of equipping homes with water-saving household appliances, including a water-saving toilet, shower head and a waterless washing machine, on nutrient concentration profiles.

Table 79 Main task regarding material recovery in Filton Airfield

Case Study & Subtask	Technology baseline	NextGen intervention in circular economy for water sector	TRL	Capacity	Quantifiable target
#9 Filton Airfield, UK Sub-task 1.4.9	A former airfield in South Gloucestershire, north of Bristol, UK - YTL Developments will develop this former airfield into an attractive and sustainable area	Decentralised nutrient recovery solutions for increased circularity in new housing districts	TRL 9	113 housing units	Nutrient concentrations in wastewater: nitrogen and phosphorus concentrations

6.4 Benefit to end-users and beyond

In the frame of the Filton Airfield development, occupants, Wessex Water in the UK and YTL Developments (UK) Ltd are the main end-users/beneficiaries. In particular, YTL as a developer



will lead an investigation of the acceptance of secondary products (water reuse, heat reuse/recovery and fertilisers from wastewater) by authorities and industries. Therefore, the use of circular solutions will add opportunities including marketing and public image.

The results drawn from the project can be recognised as a ‘first showcase’ for planners, developers and designers to adopt this approach for the nutrient recovery scheme and thus reduce pressure on the sewer system. Direct benefits that can be integrated for future research are as follows:

- ✓ District nutrient recovery development study will provide an insight into how nutrient recovery concentrations perform under different wastewater discharge profiles.
- ✓ The implemented approach can be applied to a new sewer design that transports wastewater at a higher density (lower water content), enhancing recovery efficiency. This will make possible decentralised and integrated water and nutrient recovery solutions feasible.
- ✓ Results obtained from the NextGen project can be used to understand the nutrient recovery potential in the pre-design stage of a new housing district development.

6.5 Methodology: nutrient recovery potential

6.5.1 Study site – Filton Airfield eastern infrastructure

At the time of the study, the other stages of the development (commercial and residential areas) were under the design stage. However, it has to be noted here that the residential development information (housing types, diurnal patterns, water use habits, family size etc.) considered in this study can be representative of the future stage of residential development. In the further stage of building new residences, only the number of housing units will differ as per YTL’s new proposal submitted in April 2022, the total number of housing units will be increased from 2675 to 6500.

This study thus focused on the sewage network of residential houses from the first stages of building of the Hangar District, consisting of 80 houses and an apartment block, namely the Navigator Building. These 80 houses can be broken down more specifically into 8 two-bed houses, 60 three-bed houses and 12 four-bed houses, and the apartment block is a mix of one and two bed apartments with a total of 33 apartments. The first development stages that this research project will produce a sewage model for can be seen highlighted in the orange box of Figure 75. Using information provided in the development plan produced for the Hangar District (YTL, 2021), the different houses shown in Figure 75 could be classified into sizes by bedroom number and their floorplans allowed for an assessment of the sources of wastewater into the sewage network.

Every house type was found to have one main bathroom, which contained an over-bath shower, a WC and a basin, as well as a separate WC. The wastewater from the kitchen of every house type came from a combination of the kitchen tap, dishwasher and a washing machine. The ensembles of each house type that had one were assumed to contain both a WC and a shower. All house types were also found to have an outdoor tap. The one and two-bed apartments did not have outdoor taps and only the two-bed apartments had ensuite



bathrooms with both, having the same standard bathrooms as the house types. Both apartment types also contained the same kitchen appliances as the houses. An example of the floorplan where this information was found can be seen in D1.8 (Kim et al. 2022).

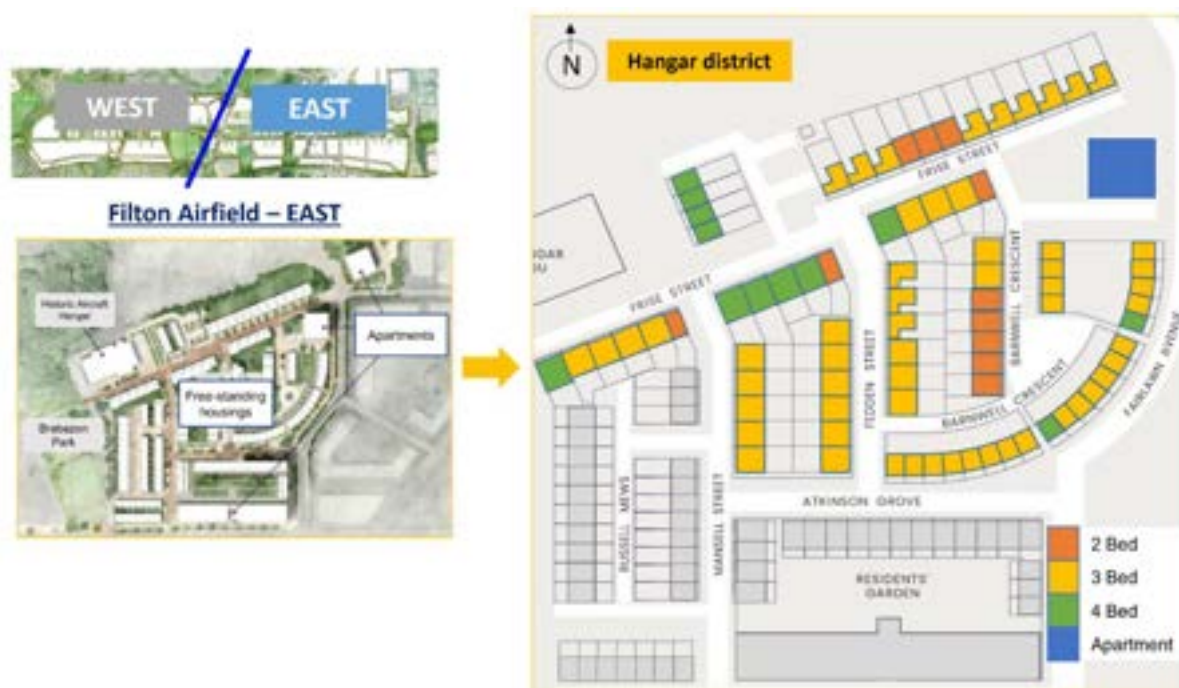

Figure 75 Map of the Hangar District development with different housing types adapted from YTL Developments Master plan. Housings with grey colour are not included for this study

6.5.2 Modelling approach

Water demand and discharge profile simulation

The approach taken to model the sewer system for the Hangar District was to use existing modelling tools: SIMulation of water Demand, an End-Use Model (SIMDEUM®) and SIMulation of water Demand, an End-Use Model Wastewater (SIMDEUM WW®; Blokker 2010, Blokker et al. 2017).

SIMDEUM® is able to produce discontinuous, random flow patterns distinctive of wastewater sewer systems. It is used to firstly create a stochastic model for an estimation of water discharge and temperature discharge patterns from households. SIMDEUM® was originally developed as a software tool in the Netherlands to model water demand patterns, using a combination of statistical and probabilistic information about inhabitants and appliance usage (Blokker, 2010). The SIMDEUM® pattern generator (SPG) thus gives information on the water demand and water discharge and is offered by the website of Watershare (<http://www.watershare.eu/>). Through the website, the software tool for Water-Use Info can be set as shown in Figure 76. The home screen of Water-Use Info consists of two parts. The first part is a tool that utilises the creation of a spg-file, which comprises the import data for the residential version of the SPG. This part is described in Section 6.5.3. The button Download SPG refers to the download of the SPG for residential water use. After saving the file, the SPG can be installed and executed in SIMDEUM Pattern Generator User-friendly Interface as shown in Figure 77.



SIMDEUM WW[®] is an extension of SIMDEUM[®] and was used to assign appliance-specific wastewater quality profiles to each wastewater discharge. Certain appliances have similar demand and discharge patterns, for example, the shower running to the drain, however, other appliances such as a toilet or washing machine may discharge much faster than they are filled. By using SIMDEUM[®] and SIMDEUM WW[®] together it is possible to produce probabilistic discharge pulse flows into the sewer network. Unlike for the SPG, however, there has been no user-friendly interface built for the SIMDEUM WW programme, meaning these wastewater quality profiles were developed within the MATLAB code of SIMDEUM WW[®] to produce time series .dat files to be integrated into SWMM[®]. A separate time series file was required for each parameter, i.e., time series files for each house type and each nutrient, nitrogen (N), phosphates (P). Separate time series files were also needed for the water-saving appliances situations. The water saving appliances were water-saving shower heads and water saving toilets. Time steps of 1 minute were used and the simulations were conducted over a 5-day period, the weekdays.

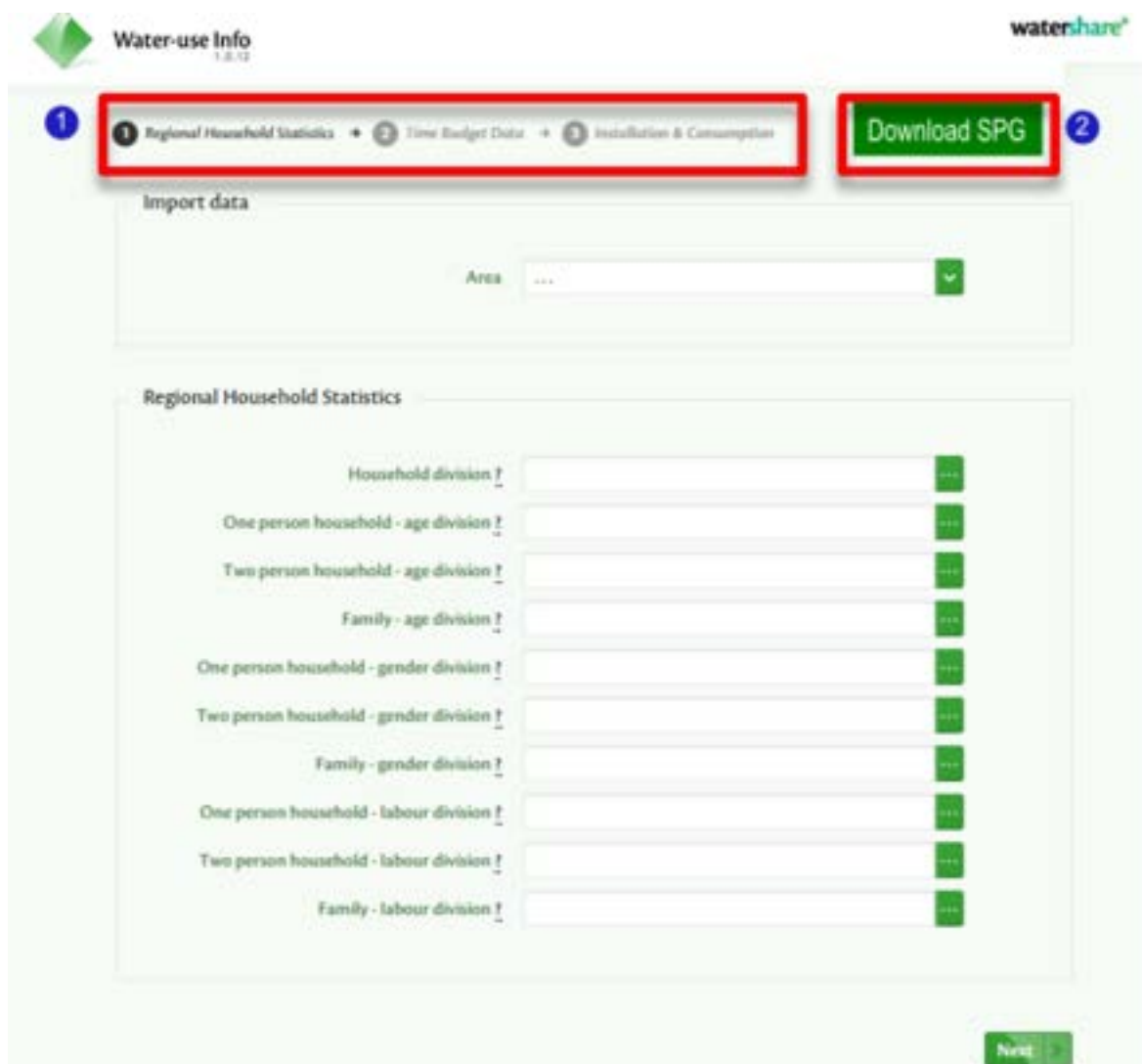

Figure 76 The start page of Water-Use Info, consisting of a tool to generate a spg-file for residential water use and a button to install the SIMDEUM Pattern Generator.



Stochastic wastewater discharge element patterns were then incorporated into the sewer network modelling software by editing MATLAB codes behind SIMDEUM which produced file types that could be inputted into the sewer network modelling programme, Storm Water Management Model (SWMM v.5.1, Gironás et al. 2010; Huber 1997).

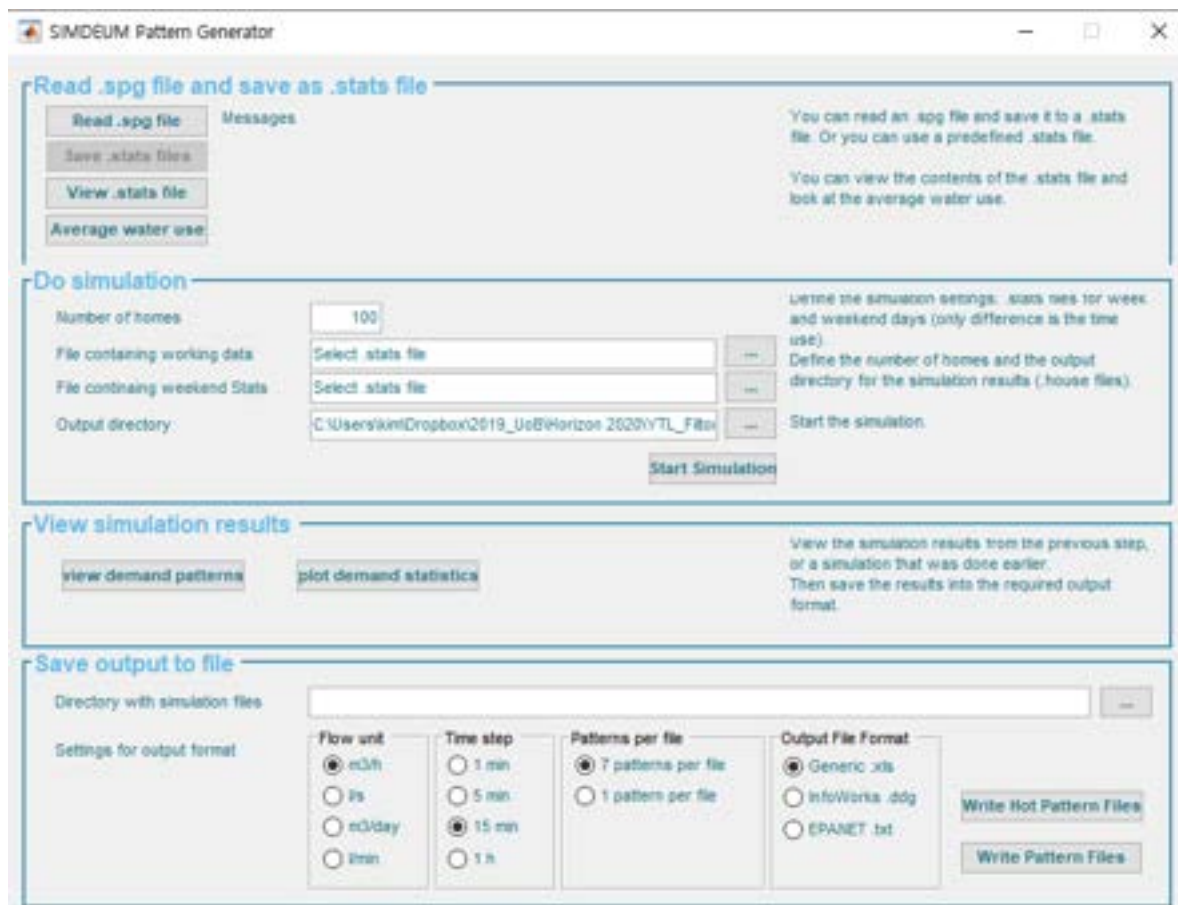

Figure 77 The home screen for the SIMDEUM pattern generator user-friendly interface

Sewer network modelling

The sewer network for the housing residential area shown in Figure 75 was developed in SWMM v.5.1 (Gironás et al. 2010; Huber 1997). For this residential development, a separated sewer network was developed, meaning it excludes storm water. The sewer network is a gravity driven system with the outfall being the lowest point of the network and the furthest house from the outfall being the highest point. There are inflow junctions from each house or apartment block and all nodes are connected by conduits. From the outfall the wastewater may be taken to a water treatment plant, where nutrients in the wastewater can be extracted. The pipe network containing all junctions, nodes, conduits, and outfall can be seen in Figure 78 and Figure 79.

Using the SWMM software it is possible to produce a cross-sectional view of the separated sewer network, from the highest point to the outfall. This cross section can clearly demonstrate the gravity driven nature of this network, as can be found in Figure 79. The vertical pipes demonstrate manhole locations from street level to the sewer pipes along the network. Each conduit was assigned a roughness factor of 0.01 and the conduits were all circular closed. The highest point of the network at 64.15 m and is the inflow from the 3-bedroom house, whilst the outfall is the lowest point at 58.665 m giving an overall elevation



change of -5.485 m. Each node shown in Figure 78 could contain inflow from one or more houses in the network.



Figure 78 Sewer network overlaid onto housing map (SWMM)

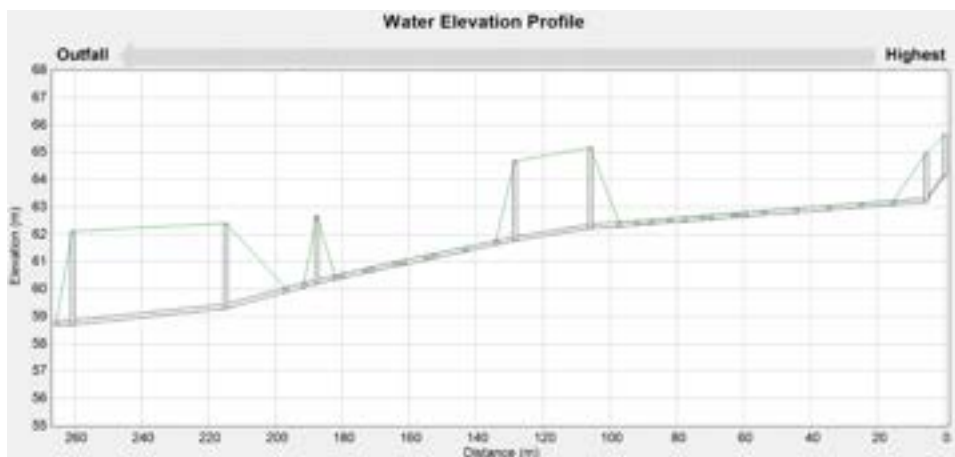

Figure 79 Cross-sectional view of the sewer network from highest to outfall (lowest) point

6.5.3 Data and model calibration

SIMDEUM was originally calibrated for the Dutch trends of water use and applications and therefore SIMDEUM required different input parameters which would better describe the UK in terms of information about household sizes, diurnal patterns, and appliance usage. By gathering data based on the UK population it was possible to input parameters which described UK habits more accurately than the average Dutch households’ habits. This could then be used to calibrate a stochastic model and produce patterns that are more suited to the case study area of Brabazon in the UK.



Data Collection

The first stage of calibrating SIMDEUM to the UK population was to gather data that could be inputted into the Water-Use Info in Watershare (<http://www.watershare.eu/>) to create .spg files. As shown in Figure 76, there are three sub-parts that need to be filled in using user’s information: (i) regional household statistics, (ii) time budget data and (iii) installation and consumption.

The regional household statistics refer to the household occupancy: one person, two person and more than two person households, i.e., a family. These household sizes were then also divided based on gender, age and labour (Blokker, 2010). This household statistics data was found through Statistics (2020). The time budget data is information on households’ diurnal patterns for each age group and divided into weekdays and weekend days. A United Kingdom Time Use Survey had been conducted in 2014-2015 by Gershuny (2017). This large-scale household survey provided data on how people in the UK use their time. Effectively, the survey provided a time diary instrument where participants would record their daily activities. This survey provided the necessary information on when people were waking up, leaving their house, returning home, and going to sleep.

The survey data was provided in a large Excel sheet which had to be sorted through to find the necessary information. The survey was conducted on the age groups 8-12, 13-18, 19-64 and 65+ year olds. The adult age group was also further divided into working adults and nonworking adults. Using COUNTIF functions in excel, the survey information could be refined into the necessary data required for the SIMDEIM simulations. This information on when people are sleeping and when they are away from home can be plotted to represent the general pattern (all age groups) as shown in Figure 80. The daily average trend during the weekdays for all different age groups is presented in D1.8 (Kim et al. 2022).

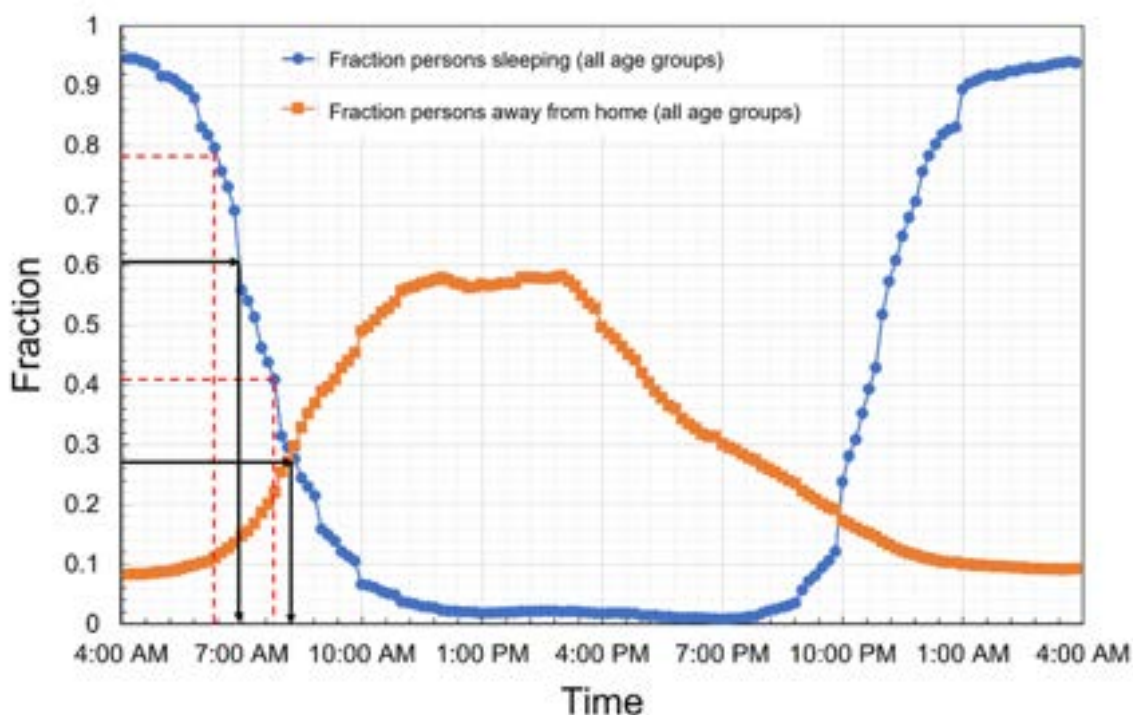

Figure 80 Daily trend of all age groups sleeping (o, blue) and away from home (*, orange). The dashed red line indicates the method for calculating the standard deviation around the time of getting up and sleep. Values obtained from this figure were summarized in Table 80 and used for SIMDEUM simulation.



To find the average time people wake up, the midpoint fraction of the highest and lowest point of people sleeping was found as 0.609 that corresponded to a wake-up time of 6:59 AM. To find the average time of leaving the house, a similar procedure was followed. The midpoint fraction of the peak of people being away from home and the low point of people being at home was found as 0.27 which corresponded to an average leave time of 8:09 AM. Similar procedures were followed to find the average times of people returning home and going to sleep. Using these times, it was possible to work out the average duration of people being away from home as well as the average duration of people sleeping, required for the simulation.

Other necessary data that had to be inputted into the calibration was the standard deviations around the times and durations calculated. Under standard deviation rules, 68% of the data lies within one standard deviation from the mean. The red dashed lines on Figure 80 therefore show the method for calculating the standard deviation around the time of getting up. 68% was calculated of the number of people awake at the average wake up time and then subtracted and added to the mean. These fractions were then read across to find the time standard deviation and an approximate standard deviation of 1:00 was found for the time of waking up, as shown by the red dashed lines. A similar procedure was then followed to find the standard deviations around the time of leaving the house, duration spent away from home, and duration sleeping, as can be seen necessary in Figure 80.

People tend to be awake during daytime hours and if people are away from home it tends to also be during the day. The fraction of people away from home at 12:00 PM is about 15% lower during the weekends, which fits the trend of people leaving home for work during the week. Using these graphs for each age group the average wake up times, average time of leaving the house, duration of being away from home, duration of sleeping and their standard deviations could all be calculated. As a result, these results are summarised in Table 80, where μ shows the average, σ shows standard deviation, week stands for weekday and weekend stands for a weekend day.

Table 80 Summarised time budget data for the UK.

		Time Waking Up		Time Leaving House		Duration Away		Duration Sleeping	
		μ	σ	μ	σ	μ	σ	μ	σ
Child	Week	07:11	0:30	08:20	0:40	8:00	1:00	9:56	0:30
	Wend	07:57	1:00	09:35	1:00	8:50	1:30	10:24	1:30
Teen	Week	07:17	0:50	08:02	0:45	8:38	1:30	8:46	0:50
	Wend	09:10	0:50	10:35	0:45	9:17	2:30	10:12	1:00
Working Adult	Week	06:31	0:30	07:44	0:30	9:32	1:15	7:34	0:30
	Wend	06:58	1:15	08:01	1:00	10:54	2:00	7:50	1:00
Home Adult	Week	07:22	0:30	08:45	1:30	9:46	1:30	8:20	0:50
	Wend	07:59	0:50	09:52	1:30	8:48	2:00	8:51	1:00
Senior	Week	07:15	0:45	09:17	1:00	7:32	1:30	8:15	1:00
	Wend	07:35	1:10	09:35	1:00	7:48	2:30	8:32	1:20
Total	Week	06:59	1:00	08:09	0:50	9:48	1:10	8:07	0:50
	Wend	07:55	1:30	09:31	1:30	9:29	2:00	8:57	1:30



The data shown in Table 80 was inputted into the Water Use-Info under the ‘Time Budget’ section for the creation of the .spg file types necessary for SIMDEUM.

The final section for the Water-Use Info was the *installation and consumption section*. Water demand in households depends on the number of water-using appliances in the house, for example a shower, a bath, two toilets, etc. as well as the characteristics of the appliances, such as frequency of use, flow rate, duration of use and desired temperature. Depending on the user of the appliance, the duration and frequency can vary, for example a senior may flush the toilet more often than a teen whilst a teen may take longer and more frequent showers than a senior. Further to this, the duration, frequency, and desired temperature of the appliance can vary from appliance to appliance as well as the application of the appliance. These different applications can be added as subtypes of the appliance in Water-Use Info, for example a bathroom tap may run hot water for shaving, but cold water for teeth brushing. Due to time constraints and the current unavailability of data in the UK situation, the installation and consumption input sections were taken from demo files provided by the SPG programme. It was therefore assumed that while there may be differences in the household statistics and the time budget data between the Dutch and UK situations, the use of appliances between the two situations is the same. Figure 81 shows some of the inputted data into the Water-Use Info for the Installation and Consumption section, taken from the demo_2014 file provided by the SPG.

The screenshot displays the 'Installation and consumption' section of the Water-Use Info software. At the top, there is a horizontal menu with several appliance categories: Bath-bath, Bathroom tap-bathroom_tap, Dishwasher-dw, Kitchen tap-kitchen_tap, Outside tap-outside_tap, Shower-shower, Washingmachine-wm, Toilet-wc1, and Toilet-wc2. Below this menu, a list of input fields is shown for various user groups: Penetration (100.0), Child-frequency (3,800, 5,400, 4,600), Teen-frequency (4,100, 5,100, 4,700), Working adult-frequency (5,300, 6,800, 6,000), Home adult-frequency (7,000, 7,000, 7,000), Senior-frequency (7,400, 6,800, 7,200), and Total-frequency (5,300, 6,400, 5,900). Other fields include Daily pattern (NONE), Offset (0.0), and Name. A green 'Add' button is located at the bottom right of this section. Below the main form, a smaller window titled 'wcSavePlus' is visible, containing fields for Penetration (average), Duration (2.4), Flow (0.042), and Temperature (10.0).

Figure 81 Installation and consumption of Water-Use Info in Watershare (<http://www.watershare.eu/>)



For the normal household appliance situation there was no subtype for the shower, toilet or washing machine. However, for the water saving appliances situation subtypes were added to each of these appliances. For the toilets, a wcSavePlus subtype was added to each, for the washing machine, a waterless subtype was added and for the shower, a water saving shower head subtype was added. The water saving shower head reduces the flowrate of water, the waterless washing machine fills with less water and the SavePlus toilet fills its reservoir for less time at the same flowrate, meaning a decreased reservoir volume and therefore less water into the sewer network per flush.

Water demand simulation - SIMDEUM

Once all three parts of the Water-Use Info had been completed, the data could be saved and exported into an .spg file type. If necessary, these .spg files could be opened in a notepad app as .txt files and be easily manipulated.

Using the downloadable SPG from the Watershare webpage, the .spg files could be read and saved as .stats files as shown in D1.8 (Kim et al. 2022). Using the SPG interface it was possible to view the household statistics information of the .stats files. This information on household statistics is summarised in Figure 82 for a 2-bedroom house type. The distribution of single, two person and family households are defined in the middle of Figure 82 and the other parameters including age, gender and labour division are shown around the edge.

Using this household occupancy information as well as the time use data summarized in Table 81, together with the water consumption information for each appliance, SPG was able to run a simulation and produce discharge profiles for each house type.

Wastewater discharge simulation – SIMDEUM WW

The next stage was to input these discharge profiles for each house type into the SIMDEUM WW code to produce appliance-specific wastewater quality profiles. Appropriate input values for the pollutant discharges were found and are summarised in Table 81 (Bailey et al., 2020a; Bailey et al., 2020b). Discharge qualities may come from a variety of sources, for example, detergents, food scraps, human waste etc. These discharge qualities were added to MATLAB code as fixed input values. As the discharge qualities shown in Table 81 are in $g \cdot use^{-1}$ the code was altered to convert the concentrations into $g \cdot L^{-1}$. This was done by taking the discharge profile and dividing it by the flowrate, measured in $L \cdot s^{-1}$. The code in MATLAB was then run to produce .dat files of the water discharge quality patterns for each nutrient type and then each house type with either standard appliances or water saving appliances.

Table 81 Appliance specific pollutant concentrations

Household appliance	Discharge Temperature (°C)	Discharge sewage quality ($g \cdot use^{-1}$)	
		N	P
Shower	35	0.49	0.00
Toilet	23	0.22	0.90
Kitchen Tap	40	0.35	0.03
Bath	36	0.85	0.00
Bathroom Tap	40	0.04	0.00
Washing machine	(35, 35, 35, 40)	0.64	0.00
Dish washer	35	1.35	2.04



Sewer network simulation - SWMM

Using the files produced from SIMDEUM WW these stochastic household discharge profiles were integrated into the sewer network developed within SWMM, shown in Figure 78. Each house has a node which can be matched to a specific time series, e.g., a time series of flow rates or a time series of nitrogen concentration. SWMM runs the wastewater quality model alongside the hydraulic model to produce realistic patterns. The concentration at every node is calculated for every time step, following the conservation of mass. It is assumed that the nodes are well mixed and there is no deposition or accumulation along the system. Dispersion along the conduits is also assumed to be negligible in SWMM and pollutants move through the conduits at a constant velocity.



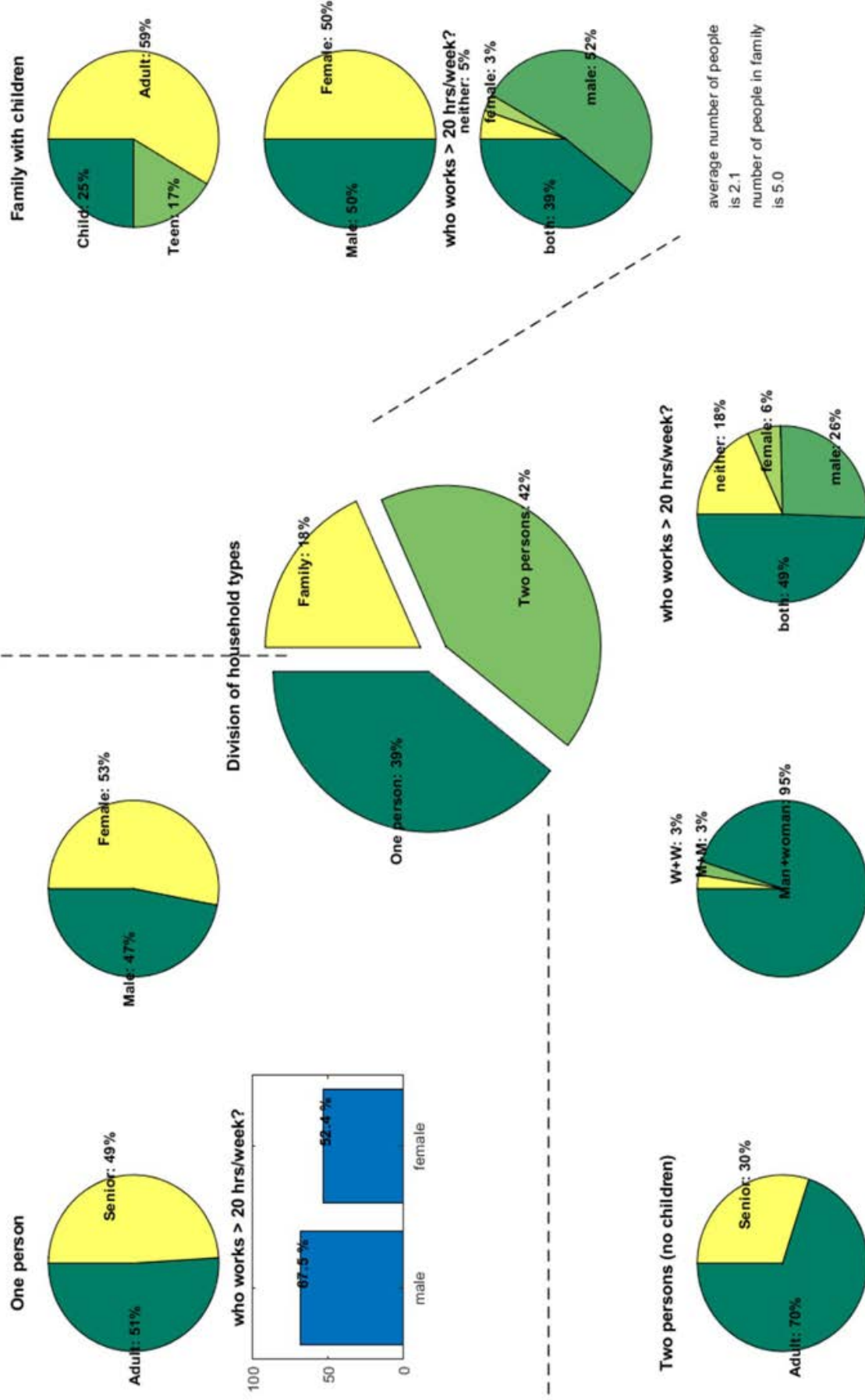

Figure 82 Household statistics data – an example of two-bedroom house

The SWMM simulation can then be run and the time series that results at the outfall for the 5-day period can be exported to Excel. The procedure followed in this research project can be seen summarised in Figure 83.



Figure 83 Outline of simulation procedure

6.6 Results: Nutrient profiles in a new housing development under different scenarios

Model calibration results

The occupancy of each household type could be found in Figure 84. In the Navigator building there are 12 one-bedroom apartments and 21 two-bedroom apartments, so the average apartment occupancy was found as a weighted average of the one- and two-bedroom house types for the specific case study of the Navigator Building. An expected trend can be seen in Figure 84, as the house type gets larger the number of occupants increase, as can be seen by the fact that the percentage of 2-bedroom houses with 2+ persons is 18% whereas for 4-bedroom houses it is 51%. These occupancy values were used in the ‘Household Statistics’ section of the Watershare tool in the creation of the .spg files for each house type.

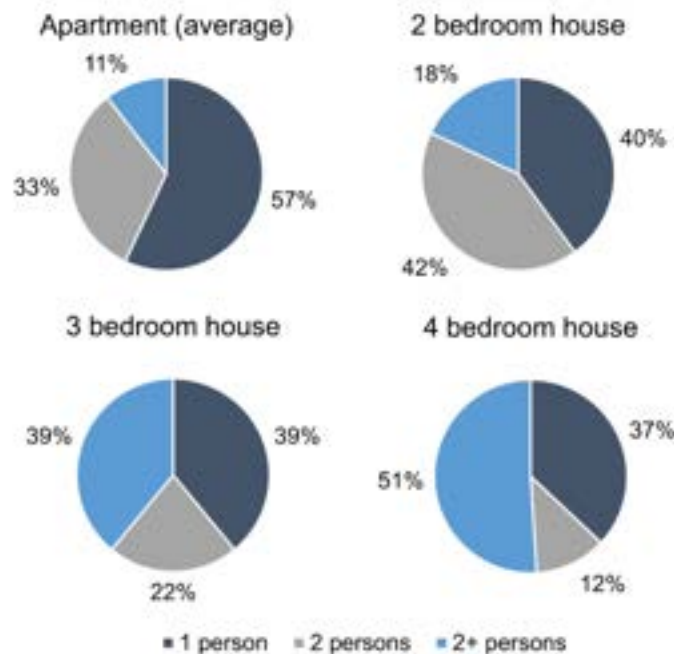

Figure 84 Occupancy for each house type (apartment and free-standing house)

Variations of wastewater flow rates

Figure 85 shows the wastewater flow rate ($L \cdot s^{-1}$) for both household appliance scenarios where NA is normal appliances and WSA is the water saving appliances. A clear diurnal pattern can be seen in Figure 85 with both morning peaks and evening peaks. The morning peaks are sharper while the evening peaks are more spread out. This is because people all tend to start work and school at the same time in the UK, around 9:00 AM meaning people tend to shower



etc. around the same time before work or school. In the evenings people finish work or school over a larger range of times so the spread of when people are using the water consuming appliances is larger. People also tend to be awake and at home for more hours after work than they are before work, meaning they may use the toilet or taps more times, which explains the wider spread in the evening peaks.

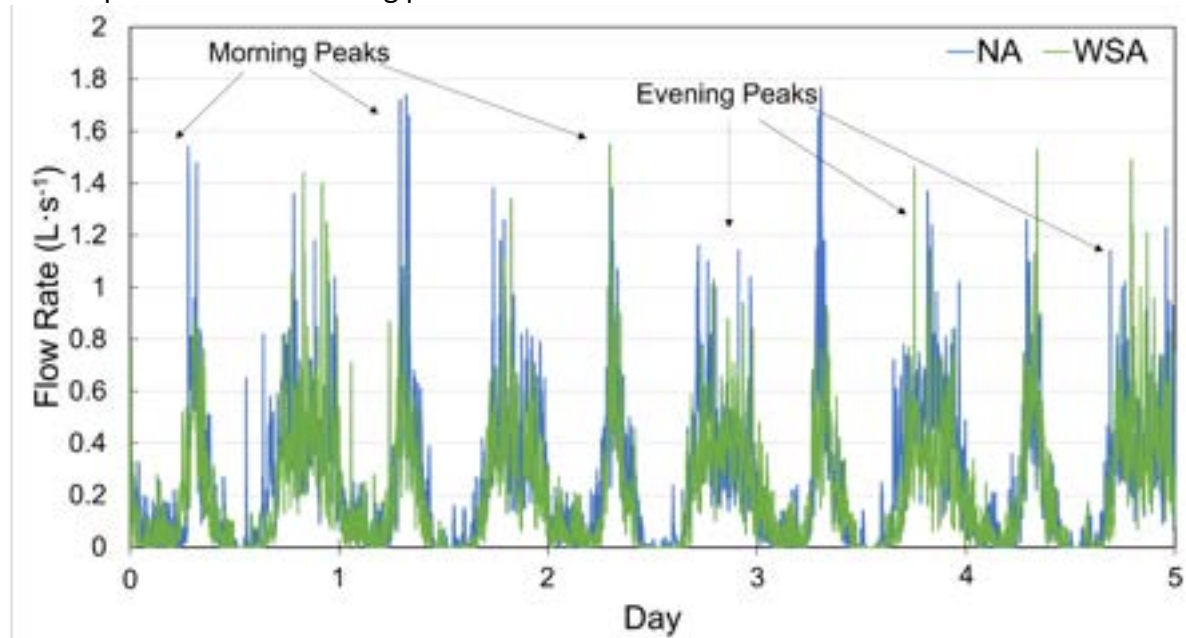

Figure 85 Wastewater flowrate at network outfall for a 5-day period. NA: Normal appliances, WSA: Water saving appliances

In order to compare the effects of using water saving appliances compared to normal appliances, a period of 1 day was chosen to clearly demonstrate the difference, as can be seen in Figure 86, with day 1. A morning peak period of 6:30 AM to 9:30 AM and an evening peak period of 4:30 PM to 11:30 PM was chosen based on the data trends.

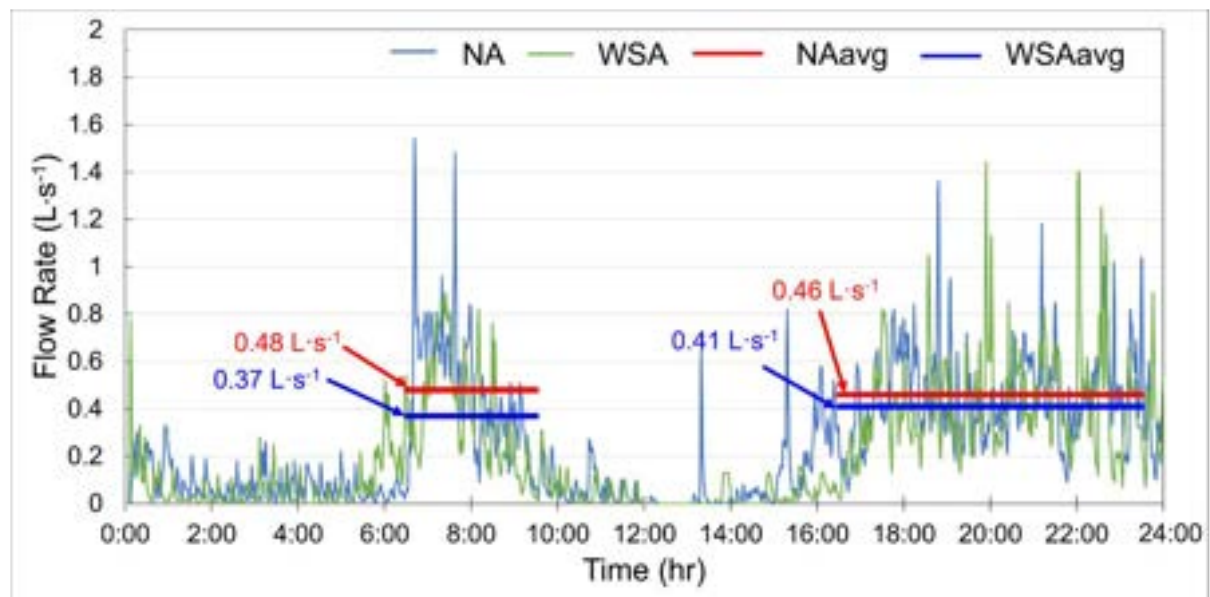

Figure 86 Flowrate of wastewater comparing normal household appliances and water saving household appliances. NA: Normal appliances, WSA: Water saving appliances. Morning - 6:30am-9:30am, Evening - 4:30pm-11:30pm.



As can be seen in Figure 86 the average flowrate over the morning period is $0.11 \text{ L}\cdot\text{s}^{-1}$ lower on average using the water saving appliances. This confirms the idea that using water saving appliances will lead to a lower flowrate of water into the sewer system and therefore dilution should be reduced. These averages were calculated for each of the 5 days that the simulation was run for and compared to check the reliability of a stochastic model. Figure 87 shows the average flowrate over the morning period, comparing the normal appliances with water-saving appliances. Error bars are also shown on Figure 87.

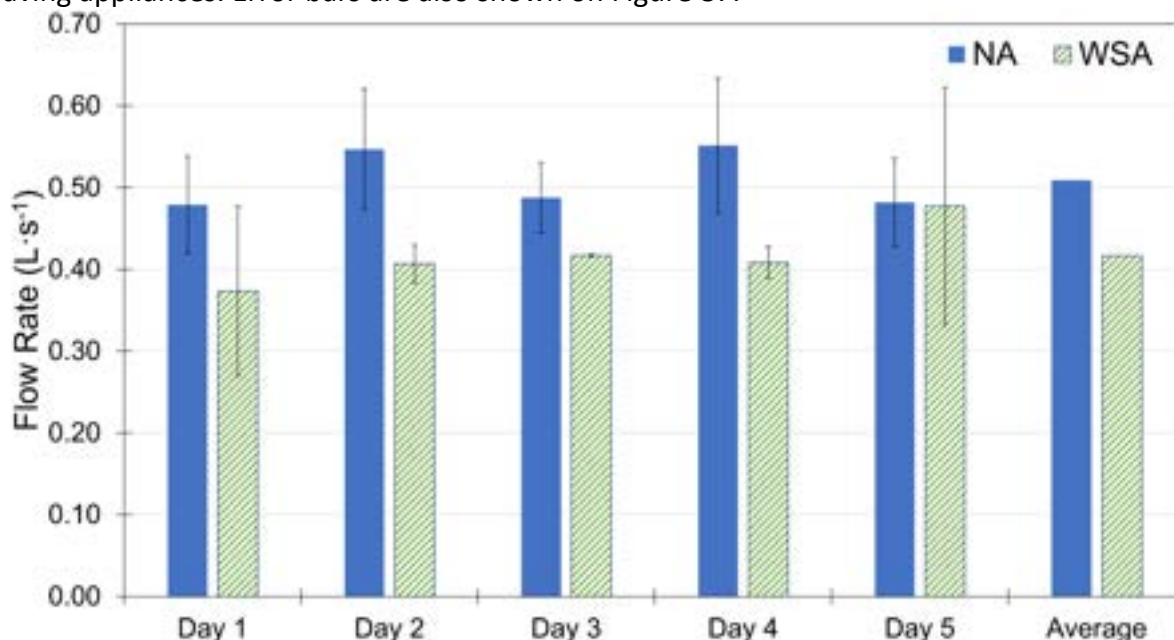

Figure 87 Average flowrate over the morning period (6:30am-9:30am) for each day. NA: Normal appliances, WSA: Water saving appliances.

As can be seen on Figure 87 the stochastic model holds true for each day, where the water saving appliances give a lower flowrate of water into the sewer network when compared with the normal appliances. The average flowrate for the whole 5-day period for normal appliances is $0.09 \text{ L}\cdot\text{s}^{-1}$ higher than for the water saving appliances. Each bar for days 1 to 5 also shows an error bar. This is because the flow rate for each day is different due to the random nature of the stochastic model. The SIMDEUM program gives random usage patterns to each household appliance which can mean, for example, on some days the toilet is flushed more frequently, which would lead to a higher flowrate into the sewer network. The trend does generally hold true, however, that the NA use more water than the WSA for days 1 to 4. On day 5 the average morning flowrate from the NA and the WSA is the same at around $0.48 \text{ L}\cdot\text{s}^{-1}$, which can be explained by the random nature of the model.

Variations of nutrient concentrations in wastewater

In order to observe the effects of the decreased flow rate using WSA on the nutrient concentration in the wastewater, the concentration time series produced from SIMDEUM WW were linked to each house type in the SWMM sewer network along with the flow time series and the simulation was run for the same 5-day period. This was done for nitrogen (N) and phosphorus (P) concentrations. The simulation results for the other nutrients can be seen in Figure 88 (a) and (b), respectively.

For example, Figure 88 (b) shows the concentration of phosphorous at the outfall of the SWMM sewer network for the 5-day weekday period that the simulation was run for. As for



the flowrate in Figure 85 the same diurnal pattern can be seen. The phosphorous concentration is higher when people are using the household appliances in the morning and evening periods, and phosphorus is being added to the wastewater system. The concentrations of other components present similar trend with the concentration of phosphorous.

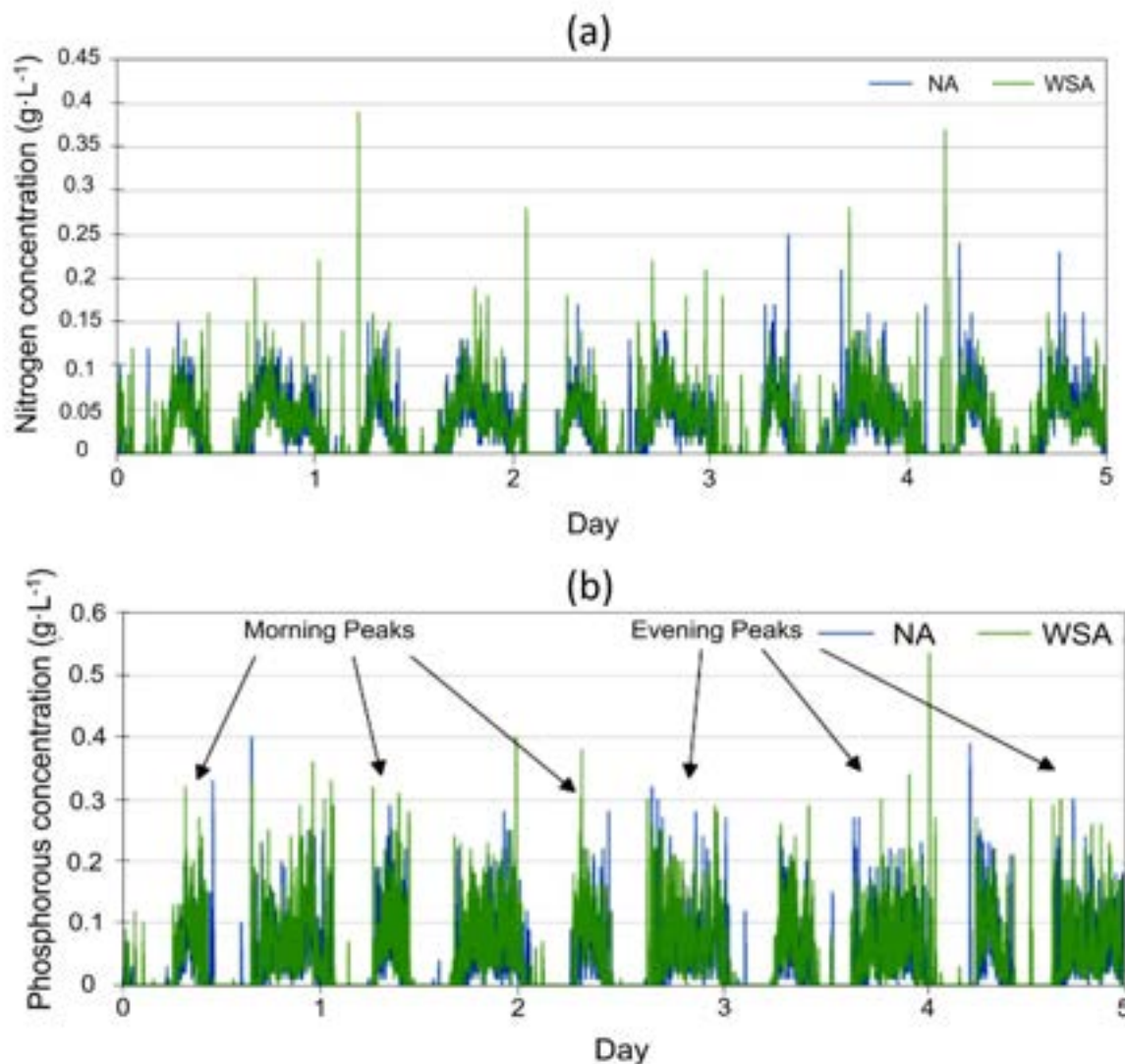

Figure 88 5-weekday simulation results of (a) nitrogen, N, and (b) phosphorous, P. NA: Normal appliances, WSA: Water saving appliances. Morning - 6:30am-9:30am, Evening - 4:30pm-11:30pm.

The diurnal pattern can be clearly seen in Figure 88 with the morning peaks of phosphorous concentration, followed by very low phosphorus concentrations during the day when people tend to be away from home, and then a more widespread evening peak period where people are at home again and using water appliances such as the shower, and finally a very low concentration period when people are asleep and not using the water appliances before the next morning. Any peaks showing an influx of phosphorus in the wastewater during the night period could be explained by people going to the toilet during the night and then using soap to wash their hands afterwards, which adds phosphorus into the wastewater system and increases the concentration. In order to see the difference in concentration between using the water saving appliances and normal appliances, a single day has been analysed in more depth, as can be seen in Figure 89.



Figure 89 shows the phosphorous concentration at the outfall for day 1 of the simulation period using standard and water saving appliances. The concentration profile for normal appliances and for water saving appliances are both shown with the averages of the morning and evening periods directly compared. As can be seen for the morning period the average phosphorous concentration is 0.019 g·L⁻¹ higher for the water saving appliances and is about 0.018 g·L⁻¹ higher in the evening period. This confirms the prediction that the lower the flowrate of water into the system, the less dilution there is and the higher the nutrient concentration. With a higher nutrient concentration, the water treatment and nutrient recovery process will be more effective. The phosphorous concentration can be seen to fluctuate late into the night after people tend to go to bed, this may be due to some household appliances such as dishwashers and washing machines being run at night with phosphorus containing detergents.

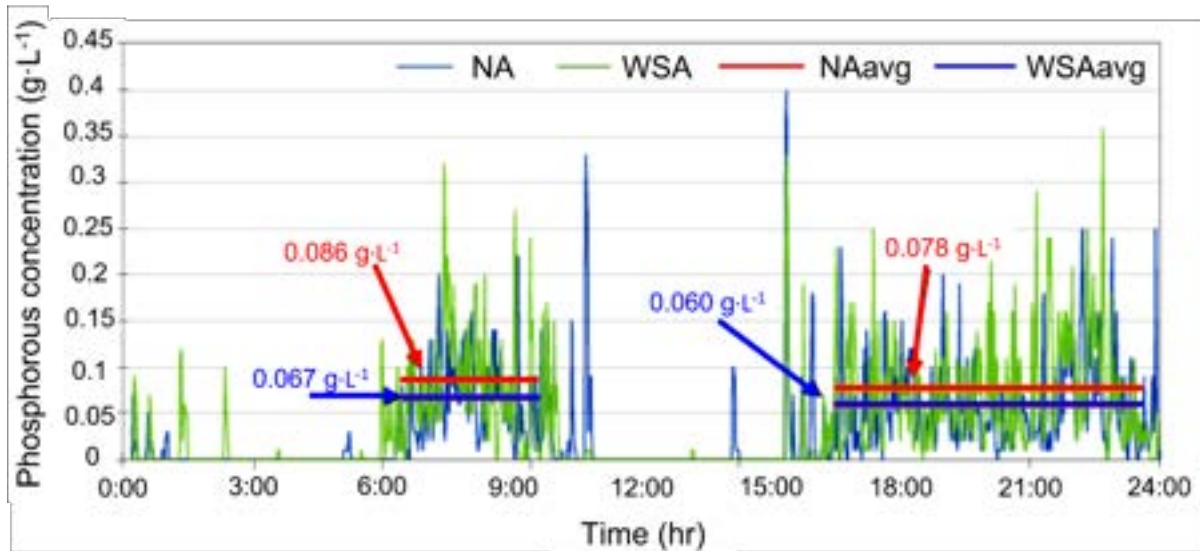

Figure 89 Wastewater phosphorus concentration comparing normal household appliances and water saving household appliances. NA: Normal appliances, WSA: Water saving appliances. Morning - 6:30am-9:30am, Evening - 4:30pm-11:30pm.

To check if this same trend holds true Figure 90 shows the average morning concentration for all 5 days of the simulation period, comparing the normal and water saving appliances.

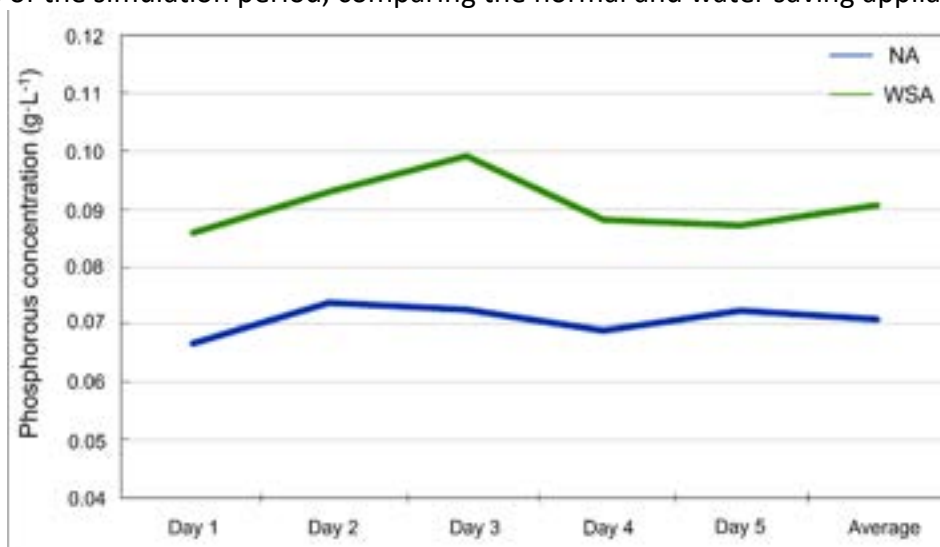

Figure 90 Average phosphorous concentration over the morning period for each day. NA: Normal appliances, WSA: Water saving appliances.



As can be seen in Figure 90 the phosphorous concentration in the wastewater is consistently higher using the WSA compared to the NA. On average, the phosphorous concentration using the WSA is $0.02 \text{ g}\cdot\text{L}^{-1}$ higher than with the NA, showing a 28% increase in the nutrient concentration of phosphorus. There is a degree of variance in the improvement from using the WSA. For example, for day 3 the concentration using WSA is $0.027 \text{ g}\cdot\text{L}^{-1}$ higher, whereas for day 5 the concentration is only $0.014 \text{ g}\cdot\text{L}^{-1}$ higher using the WSA. This confirms the randomness of the stochastic model used in this research.

Overall, the WSA in this project resulted in an average flow reduction of 18.2% for the morning period (6 am – 10 am). This water use reduction resulted in increased average wastewater concentrations of P and N by 28.4% and 3.4% respectively. These percentages were comparatively low compared to the work of (Bailey et al., 2020b) and could be explained by the fact that in the research conducted by Bailey et al. (2020) five water saving scenarios were simulated, more than the 3 tested in this research. However, the results do follow the same relative trend.

Compared to the work of Pocernich and Litke (1997) the concentrations found in these simulations were much larger, for example the phosphorus concentration for the NA scenario was in the order of 7 times the values presented in the work of Pocernich and Litke (1997). One of the main reasons for this is due to the fact that there is not a lot of data presented for separated sewer network. Most previous data appear to be for combined sewer networks where the stormwater into the network leads to high levels of dilution. Therefore, it is clear from this work that using a separated sewer network drastically increases the nutrient concentrations and therefore will increase the effectiveness of nutrient recovery at treatment plants. Wastewater treatment plants will have to be extremely effective in removing most of the nutrients in order to reduce environmental impacts such as eutrophication caused by the increased nutrient concentrations. From the data presented here it is also clear that using WSA leads to higher concentrations in the wastewater which will also improve the effectiveness of the treatment plants.

6.7 Comparison of the baseline situation and the NextGen KPIs

In Filton, NextGen investigates an integrated recovery and use of nutrients - the recovery of nitrogen and phosphate from the wastewater. The corresponding KPIs are (1) the N and P recovery potential related to the effluent from residential buildings and (2) the impact of utilising water-saving devices in housings on nutrient recovery potential. Table 82 compares baseline situation and NextGen scenario. Baseline refers to the use of conventional water-based appliances in houses, while Ecohouse refers to the use of water-saving devices. The change of flow rates and nutrient concentrations (N and P) is shown in Table 82. As expected, the wastewater flow rate decreased when using water-saving appliances. This contributes to higher nutrient concentrations in wastewater discharged from the Ecohouse compared to the conventional house. For example, nitrogen nutrient concentration in wastewater discharged from the Ecohouse was $12,627.0 \text{ mg/L}$ while that from the conventional house was $5,985.7 \text{ mg/L}$. In addition, the phosphorus concentration was 211.1 mg/L for the conventional house and 303.8 mg/L for the ecohouse. This indicates that higher nutrient concentrations in wastewater can contribute to better recovery efficient.



Table 82 Impact of wastewater profile variations on nitrogen and phosphorous concentrations

				Units	Total	Average	Comments
Scenario 0 – Baseline (Conventional house)							
Discharge flow rate	Apartment	1 bed	Flowrate	L/d	2706.9	208.2	* Study area - 1st Phase of construction - The Hangar District * Weekday (5-day) basis
		2 bed	Flowrate	L/d	5895.2	294.8	
	Free standing house	2 bed	Flowrate	L/d	4490.6	320.8	
		3 bed	Flowrate	L/d	24956.9	341.9	
		4 bed	Flowrate	L/d	14128.7	353.2	
Total flow rate				L/d	52178.2	303.8	
Discharge sewage quality	Apartment	1 bed	TKN	mg/L	1381.9	106.3	
			TP	mg/L	52.0	4.0	
		2 bed	TKN	mg/L	2240.0	112.0	
			TP	mg/L	84.0	4.2	
	Free standing house	2 bed	TKN	mg/L	1440.6	102.9	
			TP	mg/L	53.2	3.8	
		3 bed	TKN	mg/L	8979.0	123.0	
			TP	mg/L	306.6	4.2	
		4 bed	TKN	mg/L	4588.0	114.7	
			TP	mg/L	176.0	4.4	
	Total TKN				mg/L	5,985.7	111.8
Total TP				mg/L	211.1	4.1	
Scenario 1 – Ecohouse: water saving devices (Impact of flow rate, residential)							
Discharge flow rate	Apartment	1 bed	Flowrate	L/d	1271.5	97.8	* Study area - 1st Phase of construction - The Hangar District * Weekday (5-day) basis
		2 bed	Flowrate	L/d	3166.8	158.3	
	Free standing house	2 bed	Flowrate	L/d	1903.6	136.0	
		3 bed	Flowrate	L/d	11293.8	154.7	
		4 bed	Flowrate	L/d	7242.2	181.1	
Total flow rate				L/d	24877.8	163.7	
Discharge sewage quality	Apartment	1 bed	TKN	mg/L	3331.7	256.3	
			TP	mg/L	89.7	6.9	
		2 bed	TKN	mg/L	5693.1	284.7	
			TP	mg/L	144.0	7.2	
	Free standing house	2 bed	TKN	mg/L	3402.9	243.1	
			TP	mg/L	72.8	5.2	
		3 bed	TKN	mg/L	18646.4	255.4	
			TP	mg/L	438.0	6.0	
		4 bed	TKN	mg/L	9600.0	240.0	
			TP	mg/L	248.0	6.2	
	Total TKN				mg/L	12,627.0	255.9
Total TP				mg/L	303.8	6.3	
Change of WW flowrate and nutrient concentration	Apartment	1 bed	Flowrate	%	-53%	*(-): Decrease *(+): Increase	
			TKN_change	%	+59%		
			TP_change	%	+42%		
		2 bed	Flowrate	%	-46%		
			TKN_change	%	+61%		
			TP_change	%	+42%		
	Free standing house	2 bed	Flowrate	%	-58%		
			TKN_change	%	+58%		
			TP_change	%	+27%		
		3 bed	Flowrate	%	-55%		
			TKN_change	%	+52%		
			TP_change	%	+30%		
	4 bed	Flowrate	%	-49%			
		TKN_change	%	+52%			
TP_change		%	+29%				
Total flow rate				%	-52%		
Total TKN				%	+53%		
Total TP				%	+31%		

The issues come since wastewater from the current sewer networks is extremely diluted, so nutrient concentrations are low which reduces the efficiency of nutrient recovery. By separating sewer networks between stormwater and residential foul water, and by using water-saving appliances in houses, the amount of water and therefore dilution in the sewer networks can be reduced, which would increase the efficiency of water treatment (Verstraete et al., 2011). In parallel, nutrient recovery reduces the likelihood of these problems while also





improving water quality and meeting government discharge limits. Another advantage of nutrient recovery is it offers the potential revenue stream by providing nitrogen or phosphorus, a growingly scarce commodity, to agricultural businesses.

Nutrient recovery from wastewater and recycling nutrients as soil or liquid fertilizers is a major challenge for the future circular economy as it is required to select a suitable recovery technology. In addition to that, it is important to evaluate the reuse potentials of the recovered nutrient and it should involve real field applications. In this context, the NextGen technology – ion exchange and hollow fibre membrane contactor demonstrated in Sernal in the UK – can be the most favourable nutrient recovery technology for Filton Airfield as the characteristics of wastewater generated in the Filton area would be similar to that utilised in the Sernal case study. Specific technological specifications can be found in Section 4.3.



6.8 Lessons learned from simulation study

Required competence	
<ul style="list-style-type: none"> ▪ Understanding recovery of urban resources from wastewater for reuse applications ▪ Understanding various resource recovery techniques and modelling skills ▪ Understanding consumer demands and perceptions of recovered nutrients from wastewater 	
Feasibility	
<ul style="list-style-type: none"> ▪ To demonstrate nutrient recovery technologies at different scales, there is a need for more involvement of local stakeholders and coordination and collaboration across horizontal (different government departments and sectors). This will provide a promising approach to maintain the way for more sustainable, resilient and inclusive urban nutrient recovery and reuse. 	
Risks	
<ul style="list-style-type: none"> ▪ Control nutrient concentrations in wastewater and understanding the impact of water saving appliances on nutrient recovery are required <ul style="list-style-type: none"> - Using water saving appliances (i.e., low flow wastewater) in residential homes and other commercial buildings needs to be encouraged. - By limiting the amount of water entering the wastewater system, dilution can be decreased, and with reduced dilution, the recovery of nutrients can become more effective. 	

6.9 Future perspectives

This study focused on dynamic sewer modelling for demonstrating nutrient concentrations in wastewater at district level. Thus, this provided insight into how using water-saving appliances affects wastewater flows and nutrient concentrations. The next stage is identifying viable resource recovery technologies which is a priority for the Filton case as the recovered nutrients are not yet considered to be viable as commercially available fertilisers due to concerns about the quality and performance of the recovered nutrients in real practices (Saliu et al., 2021).

More efforts are needed to propose the most appropriate nutrient recovery system that enhances and supports nutrient recovery strategies in Filton Airfield. In this context, it is of great significance to have a credible dataset that is adequate for either practically or regulatory applicability and demonstration. Therefore, there are a few stages recommended in the further development of the model that could be used to simulate a comprehensive nutrient recovery model for observing the effects of optimal resource recovery.

A potential change in the future would be to find better calibration data. This could be done by surveying a sample of the UK population in the specific area where the sewer network is



being developed in order to account for local habits in terms of water use. A large portion of the data used in this study for the installation and consumption section of the Water-Use Info was obtained from demo files which had been calibrated to the Dutch scenario. In the future, further research could be done on the appliances and the time they are used for in the UK scenario, for example, how often people shower and for how long. This could be done by performing surveys on a sample of the UK population.

Another change that could be made in the future is to find more recent calibration data on the wastewater quality element of the model. Some of the nutrient discharge concentrations date back a few decades and with advancements in soaps and detergents it is likely that the pollutant qualities from these sources would have changed. With the availability of more time, further studies could be performed to find more recent information on nutrient qualities from household appliances.

Another potential issue of the current form of SIMDEUM WW is that it uses average pollutant discharges per appliance. Each household appliance has the potential of producing a wide range of wastewater qualities, for example, people may use different detergents in clothes washing. To improve on the current form of the model it would be useful to be able to provide variable discharge qualities in SIMDEUM WW from each household appliance, improving on the stochastic model.

A further improvement that could be made to the SIMDEUM WW code is to integrate weekend days into the code. At the moment only weekdays have been simulated and weekday diurnal patterns have been shown. Weekend time budget data is available however, for example, when people wake up and how long they are away from home for. By adapting the SIMDEUM WW code the weekend demand patterns could also be converted into discharge profiles.



7. Discussion and conclusions

7.1 Benefits and challenges of the technologies

The main benefits and challenges of the NextGen technologies are presented in the following per topic starting with the material recovery technologies, followed by the nitrogen and phosphorus recovery technologies.

Technologies for material recovery from sludge

The rapid composting unit allows to recover carbon and nutrients from excess sludge and pruning waste, while enteric pathogens are destroyed during the composting process. It is five times faster than the conventional composting and an excellent opportunity to recycle green waste within cities. The opportunity to sell the compost can generate an income. However as a challenge, a full automation of the process is significantly more expensive than the unit presented in this deliverable and furthermore, the design models for solid-phase reactors are limited and more research is therefore needed.

The granular activated carbon (GAC) produced in Altenrhein can be operated over a long time and eliminate organic micropollutants to different extents. However, at standard operating conditions, the elimination of organic micropollutants is less compared to that of a traditional GAC. The produced GAC does not meet the legal requirements and thus, the traditional GAC is required as last polishing step to achieve the legal requirements. Consequently, as a pre-treatment before a traditional GAC, it will prolong the operation life of the traditional GAC and hence, it contributes to reduce the environmental impact compared to the use of black coal.

The investigated pyrolysis process for the case study in Timișoara showed, that a high gas quantity can be obtained with an increasing temperature. The gas can be cleaned in a condenser and an electrostatic precipitator. In addition, oil, water and char are generated via pyrolysis and can be also used as resources afterwards. However, after separating the oil from the water, the oil can be used, but the water is considered as waste and has to be disposed. Hence, not everything can be extracted from it.

Protein production to be used as a slow release fertiliser

For the purpose of the La Trappe democase, the photobioreactor operated on brewery effluent, and was supplemented with urine to balance the C/N ratio. In this way, the purple bacteria biomass was successfully cultivated, harvested and subsequently applied as a dried slow release fertiliser for microgreens cultivation in a vertical farm. Open pond reactor technology is already applied at full-scale for green algae and is in many settings considered cost-effective. Thus, with a comprehensive software designed for the photobioreactor (purple bacteria reactor) control, scale-up is considered relatively straight forward. It is important to note that the technology was designed for protein recovery from waste(water) to be used as slow release fertiliser and in the future even higher end applications, with nutrient removal as secondary benefit. Assuming the purple bacteria biomass can be used as organic 'liquid' fertiliser (without the drying step used for experimental purpose), energy costs can be



reduced to mainly artificial lighting (using relatively low energy intensive IR). Altogether, this would keep the operational costs relatively low in terms of price/quality compared to conventional technologies for nutrient recovery. With the increasing costs and supply chain issues for conventional fertilisers and the demand for circular organic products, the business model will be increasingly feasible. However, the main challenge is the dependence of the TRL on the available waste(water). Upscaling and controlling of the process such as keeping the water volume in the system constant, to ensure homogenous illumination and favour purple bacteria growth of less desirable organisms in presence of shade-producing suspended solids needs extra attention and is delicate. Therefore, building a 40ft containerised scale-up system is needed to test and fine tune the operation for the above mentioned challenge. The challenge of the business model is to develop a stable demand for this circular fertiliser/bio-stimulant beyond the vertical farm/ urban farming market, which is currently still a niche-market. The case study has shown that the photobioreactor can produce an additional value added product, i.e. diversify the product portfolio, in a treatment train focused on water recovery. More and more enterprises are hindered in expanding their facilities, because they are not allowed to use more water. A comprehensive closed loop concept with a reasonable business case, supported by a more diverse product-portfolio for proteins, will help these entrepreneurs to continue.

Nitrogen removal and recovery technologies

The case studies involved in nitrogen recovery were Braunschweig with the ammonium sulphate solution production unit via air stripping and scrubbing, Altenrhein with the ammonium sulphate solution production unit via membrane stripping in a hollow fibre membrane contactor and Sernal using an ion exchanger and a subsequent hollow fibre membrane contactor to produce solid ammonium sulphate.

In general, the benefits are the reduction of the nitrogen return load and thus, the reduction of potential N_2O emissions or even the avoidance of those emissions as in the case of Sernal. N_2O is a greenhouse gas and has the impact of 265 CO_2e . The increasing fertiliser prices due to the Ukraine crisis lead to a higher acceptance of the ammonium sulphate fertiliser. However, there is still the need to develop new markets for this fertiliser especially when it was recovered from wastewater or the liquor of dewatered digestate. Furthermore, the Fertilising Products Regulation (EU 2019/1009) does not explicitly mention the recovery of ammonium sulphate from sewage sludge or wastewater as an option, so a certificate via REACH (EU 2020/2096) might be necessary. Because the produced amounts of ammonium sulphate are relatively small, the marketing is more rewarding on a local/regional market than on the European level. Therefore, the national legislations can be applied, if they consider those recycles. Otherwise they have to be registered via REACH, which can be time consuming and expensive.

The air stripping and scrubbing is a mature technology with a robust process and provides high recovery rates between 80% and 97%. However, the necessary addition of chemicals such as NaOH and H_2SO_4 needs special knowledge and new training of the personnel at a classical WWTP. Also the prices of chemicals are currently increasing and as shown for the case of Braunschweig, the quality of the fertiliser depends highly on the quality of the added H_2SO_4 . If the ammonium concentration is not high enough for the ammonium sulphate production, it can be accumulated via an ion exchanger as in the case of Sernal. The operation and control is easy as well as its upscaling. It is a relatively simple and fast process that does not require



any start up time. Its energy demand is relatively low and depends only on pumping of the in- and outflows.

Phosphorus removal and recovery

Phosphorus was recovered in Braunschweig using a struvite production unit. Struvite was shown to be a high quality product, the process contributed to a significant reduction in the phosphorus return load in the WWTP due to a high phosphorus recovery rate of over 80% in the unit. Because of the currently increasing fertiliser prices, the acceptance of struvite from treated wastewater is increasing. Nevertheless, new markets need to be developed for the renewable fertilisers originating from treated wastewater. Since 2021, at least struvite and other precipitated phosphate salts recovered from wastewater and sewage sludge are included in the Fertilising Products Regulation via the amendment (EU 2021/2086), which is an important step for their marketing. However, other recovered fertilisers from sewage sludge and wastewater are not considered yet in the regulation.

In Braunschweig, the technology requires a high maintenance, the struvite crystal size is difficult to control and the addition of chemicals such as NaOH and $MgCl_2$ is necessary. Therefore, specific knowledge of their handling is required.

This also applies for the Hydroxyapatite production in Sernal, where the precipitation is initiated by adding hydrated lime. Not only a new training is needed, also a new thinking for WWTP operators is required.

To apply those technologies, a certain phosphorus concentration must be maintained for the precipitation processes. If the concentration is not high enough, an ion exchanger can be applied as in Sernal to accumulate phosphate. As already mentioned, the ion exchanger is easy to operate and control, it does not require a start-up time and can be easily up-scaled. Its energy demand depends only on the pumping processes for the in- and outflows and no direct GHG emissions occur.

In Altenrhein, a PK fertiliser was produced via a thermal treatment. This process is a one stage process and the investment costs are in a similar range as for a mono-incineration. The operating costs become even lower compared to a mono-incineration, if the product can be sold at a reasonable price. The challenges are however, the requirement of a separate drying process to approximately 90% for which energy from the thermal treatment can be reused and the potential necessity to blend the fertiliser with a P- and/or K-fertiliser to sale it.

7.2 Best applications of the technologies

Ten different technologies have been investigated in NextGen with different points of application. In Figure 91, the points of applications are presented in an overview scheme. The scheme shows, that only three technologies are applied on a main stream and the others are applied on side streams. Furthermore, five technologies need a solid free feed stream such as a liquor and five technologies valorise thickened sludge or even dried material. In the following sections, the best applications of the technologies are summarised, compared and presented together with their TRLs, key performance parameters such as recovery rate, crucial feed stream concentrations, their demand for energy, for chemicals and indications regarding their potential corresponding to an upscaled system. The data for the upscaled system were gained in cooperation with WP2 and are explained in detail in D2.1 (Remy et al. 2022). Data regarding costs are available in D2.2 (Nättorp et al. 2022) and are not shown here.



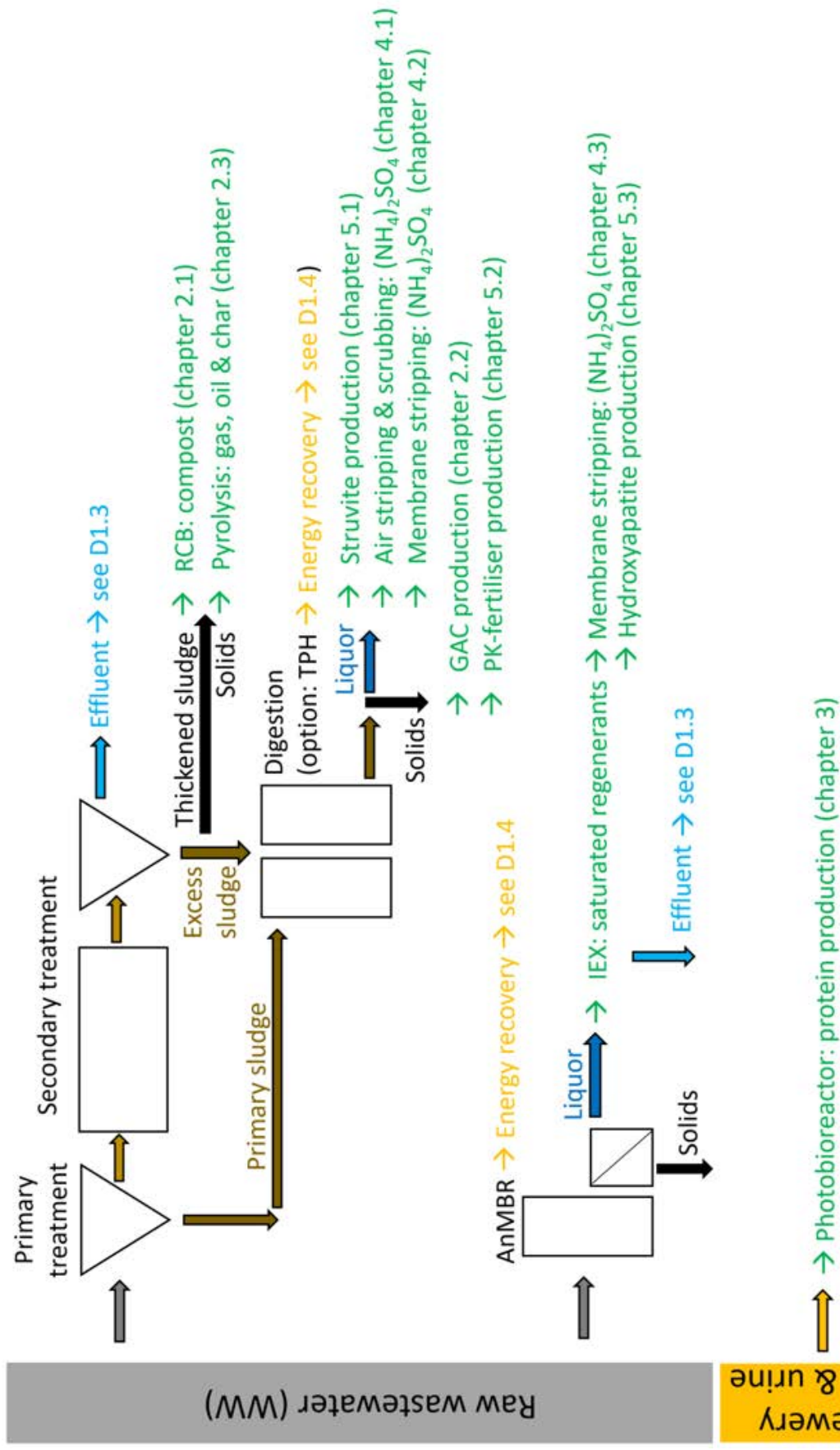

Figure 91

Overview about the different points of application for the NextGen material recovery technologies (AnMBR: anaerobic membrane bioreactor; RCB: rapid composting bioreactor; TPH thermal pressure hydrolysis, GAC granular activated carbon); here: no distinction between centralised and decentralised systems

Technologies for material recovery from sludge

The tested technologies for material recovery from sludge have a technology readiness level of 7 and 4 (Table 83, Figure 92). Thus, further investigations and tests are recommended before their implementation at full-scale. Table 83 shows the relevant parameters referring to the pilot plants and their up-scaled systems.

Table 83 Summary of the crucial parameters for material recovery from sludge in NextGen

	Athens	Altenrhein	Timișoara
Technology	Rapid composting bioreactor (TRL 7)	Pyrolysis (TRL 7)	Pyrolysis (TRL 4)
Product	Compost	Granular activated carbon (GAC)	Gas
Recovery rate	C: 60%; N:80%; P: 100%	50% GAC 50% gas, sieving losses	18% gas, 63% char, 2% oil
Flow rate	5 t compost/a	1 kg dried sludge/h	2.1 kg dried sludge/h
Chemicals/additives	Pruning waste & inoculum, heat	N ₂ , heat; H ₂ O and CO ₂ for activation	N ₂ , heat
Upscaling (D2.1) or suitability	600 PE: 1 t N/a & 0.34 t P/a	Suitable as pre-treatment for conventional GAC filter	400 000 PE: 3100 m ³ gas/d
Energy demand (upscaled system; D2.1)	410 kWh/(t compost)	No data available	



Figure 92 NextGen technologies for material recovery from sludge with dry matter (DM) contents of their inflow streams

The rapid composting bioreactor can be best applied in a decentralised system e.g. in combination with a membrane bioreactor. The resulting excess sludge has to be thickened to a dry matter content between 5 and 7%. In addition, the pruning waste has to be shredded and then blended with the thickened sludge. The recovery rate is 100% and the pilot plant produces 5 t compost per year that is reused at the tree nursery and substitutes conventional fertilisers with 80 kg N/a and 27 kg P/a. For a full-scale system (600 PE), the substitution of 1 t N/a and 0.34 t P/a is expected. This corresponds to 15% of the nitrogen load and 72% of the phosphorus load of the raw wastewater being the influent to the sewer mining unit.



The thermal treatment and also the pyrolysis are suited to be applied at a centralised system such as a WWTP. In order to produce GAC, the sewage sludge has to be dried to a dry matter content of around 90%. In NextGen, two different GACs were produced: one based on sewage sludge and one based on dried cherry pits. The sewage sludge GAC performed better than that produced from cherry pits. Hence, the results suggest to apply the technology with digested sewage sludge. The renewable GAC is suited for a pre-treatment upstream to a conventional GAC filter, since it does not reach the required level of micropollutant elimination. However, it is very well suited to prolong the lifetime a conventional GAC filter via its application as pretreatment.

For the pyrolysis process applied for the case study in Timișoara, the excess sludge was also dried to a dry matter content of 84% prior to its treatment. High quality gas and oil were produced. The higher the organic content of the sludge, the higher the recovery rates of gas and oil are. For a full-scale pyrolysis in the case of Timișoara, around 3100 m³ fossil gas/d are expected to be substituted with the pyrolysis gas.

Protein production

The photobioreactor produces microalgae which can be reused as protein-based slow release fertiliser or even as fodder (Table 84, Figure 93).

Table 84 Summary of the crucial parameters for protein production

	La Trappe
Technology	Photobioreactor (TRL 5-6)
Product	Proteins as slow release fertiliser
Recovery rate	COD: 38%; N: 20%; P: 25%
Flow rate	60 L wastewater/d
Additives, etc.	Artificial light
Energy demand	Energy for pumps and lights (no detailed data available)
Suitability	Pilot: 276-575 kg dried biomass/a → Successfully tested to grow microgreens

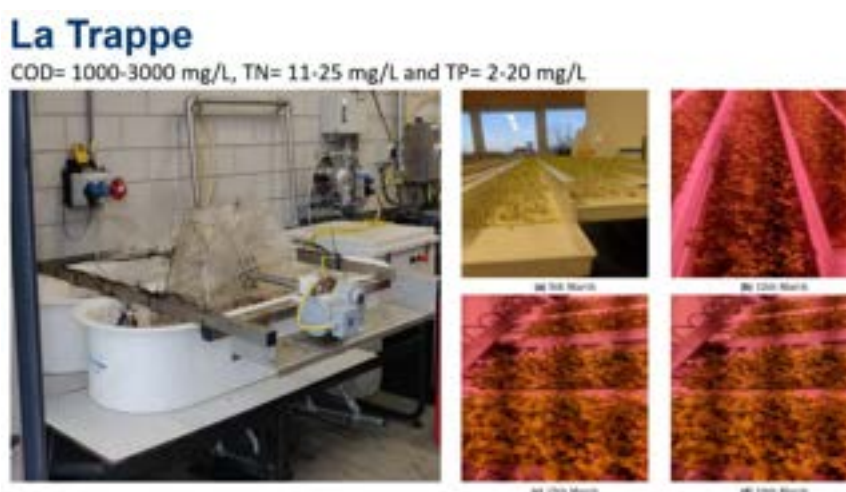

Figure 93 Photobioreactor with influent concentrations of COD, TN and TP



Its TRL is still low between 5 and 6 and thus, further investigations are recommended before its full-scale implementation. Its best application was in a main stream treatment of brewery wastewater and urine. However, it can also be applied for a side stream treatment of concentrates resulting from a membrane treatment such as a combination of UF and RO. The recovery rates for COD, N and P are 38%, 20% and 25%, respectively.

Compared to the other technologies for N and P recovery, the recovery rates are much lower. However, this technology does not require any chemicals as the other technologies and depending on the protein quality it can be even reused as fodder or food additive. The photobioreactor produced roughly 0.48 g TSS biomass per litre wastewater. This corresponds to a production of around 276 to 575 kg of dried biomass per year to be used as a slow release fertiliser. The slow release fertiliser was successfully tested to grow microgreens.

Nitrogen recovery technologies

The nitrogen recovery technologies vary in their TRL from 6 to 9 (Table 85, Figure 94). Thus, for the ion exchanger and the hollow fibre membrane contactors (HFMC) further investigations and tests are recommended prior to their full-scale implementation. Their points of application can be in a side stream such as the liquor from dewatered digestate (TSS <600 mg/L) with an influent NH₄-N concentration between 300 and 1700 mg/L as in the cases of Altenrhein and Braunschweig or in a main stream as in Sernal e. g. in the AnMBR effluent after ultrafiltration (TSS < 10 mg /L).

Table 85 Overview about the crucial parameters of the nitrogen recovery technologies

	Sernal	Altenrhein	Braunschweig
Technology	IEX & HFMC (TRL 6)	HFMC (TRL 8)	Air stripping & scrubbing (TRL 9)
Product	Ammonium sulphate	Ammonium sulphate	Ammonium sulphate
Recovery rate	N: > 76%; IEX: >80%; HFMC: >95%	N: 75%	N: 85-97%
Flow rate	1 m ³ AnMBR effluent/d	8.5 m ³ centrate/h	7-19 m ³ liquor/h
Chemicals/ additives	Zeolite-N, KCl: 3.42 kg/(kg N eliminated), NaOH: 1.75 kg/kg N, H ₂ SO ₄ : 3.57 kg/(kg N in product)	NaOH (50%): 4.4 L/(m ³ centrate), H ₂ SO ₄ (96%): 4.2 L/(m ³ centrate), heat	NaOH (50%): 3.3 L/(m ³ liquor), H ₂ SO ₄ (96%): 1.4 L/m ³ liquor, heat
Upscaling (D2.1)	100 000 PE: 320 t N/a	305 000 PE: 66 t N/a	380 000 PE: 175 t N/a
Energy demand (upscaled system; D2.1)	0.02 kWh/m ³ for IEX, 0.025 kWh/m ³ for N recovery from regenerant	0.5 kWh _{el} /(m ³ , 7.7 kWh _{th} /m ³	1 kWh _{el} /m ³ , 9 kWh _{th} /m ³





Figure 94 Overview about the nitrogen recovery technologies with influent $\text{NH}_4\text{-N}$ concentrations in NextGen

Furthermore, the nitrogen recovery units can be combined with a pretreatment either to concentrate the ammonium as in Sernal with an ion exchanger from 40 mg $\text{NH}_4\text{-N/L}$ to 1500 mg $\text{NH}_4\text{-N/L}$ or with a struvite production unit as in Braunschweig to avoid undesired precipitation processes in the stripping unit. A thermal pressure hydrolysis contributes to an increase in the phosphate and ammonium concentrations in the digestion system as shown in Kleyböcker et al. 2022 in D1.4

The recovery rates of the three units are quite high ranging between 75% and 97% (Table 85). In Sernal, 1.1 kg $(\text{NH}_4)_2\text{SO}_4/\text{d}$ were produced as solid crystals. Upscaling the process to a WWTP of 100 000 PE would result in the recovery of 320 t N/a from the main stream corresponding to a recovery rate 88% referring to the nitrogen load in the influent of the WWTP.

In Altenrhein, the recovery rate of the pilot plant reached 75%. Hence, for a full-scale system with 305 000 PE the yearly recovery nitron would be 66 t N/a corresponding to 11% of the influent nitrogen load to the WWTP.

In Braunschweig, 2000 t $(\text{NH}_4)_2\text{SO}_4/\text{a}$ are anticipated to be produced under optimised conditions as ammonium sulphate solution. This amount corresponds to 175 t N/a and a recovery rate of 12% referring to the influent nitrogen load to the WWTP.

In Altenrhein, the process temperature is with 40-50 °C slightly lower than in Braunschweig with 55 °C resulting in a lower thermal energy demand. However, the process pH is slightly higher between 9 and 10 instead of 9 and 9.5 (Table 85) and hence, more NaOH is required in Altenrhein than in Braunschweig.

Phosphorus recovery technologies

As shown in Figure 95, the TRLs of the phosphorus recovery units differ between 6, 7 and 9. For the ion exchanger combined with a precipitator and the pyrolysis process further investigations and tests are recommended prior to its full-scale implementation. Even though the struvite production unit is categorized as TRL 9, for applications in new environments with another chemical composition of the wastewater, detailed tests are considered as necessary.

The points of application are different for all three technologies. In Sernal, the AnMBR effluent being a main stream is used to recover phosphorus. In Altenrhein, the dried digestate is used from a municipal WWTP and thus, it is used as a side stream technology. It should be noted, that the pyrolysis process removes only partly heavy metals which are contained in the digestate and thus, this technology might be better suited for industrial wastewaters which are “cleaner” than municipal wastewater. In general, the chemical composition of the

digestate should be investigated in terms of its heavy metal contents in order to decide, if the technology is suitable for the type of digestate/sludge.

Table 86 Overview about the crucial parameters for phosphorus recovery in NexGen

	Spernal	Altenrhein	Braunschweig
Technology	IEX & precipitation (TRL 6)	Thermal treatment (TRL 8)	CO2 stripping & precipitation (TRL 9)
Product	Hydroxyapatite	PK fertiliser	Struvite
Recovery rate	P: > 72%; IEX >80%; precipitator >90%	P: 90-100%	P: 80-97%
Flow rate	1 m ³ AnMBR effluent/d	50 kg dried sludge/h	7-19 m ³ liquor/h
Chemicals/ additives	Ion exchange resin, hydrated lime (2.64 kg/kg P)	KOH or similar (140 kg/t dried sludge)	NaOH (50%): 1 L/(m ³ liquor), MgCl ₂ (25%): 1.9 L/(m ³ liquor)
Upscaling (D2.1)	100 000 PE: 61 t P/a	305 000 PE: 260 t P/a	380 000 PE: 37 t P/a & 17 tN/a
Energy demand (upscaled system; D2.1)	0.02 kWh/m ³ for IEX, 0.005 kWh/m ³ for P recovery from regenerant	140 kWh/(t sludge input), electricity produced from off-gas heat: 250 kWh/(t sludge input)	1.3 kWh _{el} /(m ³ liquor)



Figure 95 Phosphorus recovery technologies in NexGen with feed concentrations or contents

In Braunschweig, the struvite production unit is also implemented in a side stream. Here, the liquor of the dewatered digestate is used and the heavy metal contents are far below the legal thresholds. This is also true for the hydroxyapatite produced in Spernal. The recovery rates of the technologies range between 72% and 100% (Table 86).

In Spernal, 0.5 kg Hydroxyapatite/d was produced in the pilot plant. Upscaling the process results in the recovery of 61 t P/a from the main stream of a 100 000 PE WWTP. This corresponds to 80% of the phosphorus load in the influent to WWTP.

In Altenrhein, the pilot plant produced 50 kg PK-fertiliser/h corresponding to 0.95 kg P/h. Upscaling to a full-scale plant (305 000 PE) results in a yearly recovery of 390 t P and 850 t K (Remy et al. 2022). Hereby, it should be noted, that the potassium was added from an external source in the production process of the PK-fertiliser.



In Braunschweig under optimised process conditions (380 000 PE), 300 t struvite/a can be produced (Remy et al. 2022). This amount corresponds to 37 t P/a and 17 t N/a that can substitute conventionally produced slow release fertilisers. Those amounts correspond to 16% and 1% of the phosphorus and nitrogen loads in the influent to the WWTP, respectively. It should be noted, that the combination of the digestion system with a thermal pressure hydrolysis (see Kleyböcker et al. in D1.4) contributes to an increase in the phosphate concentration and thus, increases the available dissolved phosphate for its recovery.

7.3 Transferability: application at other sites

For the transferability of the NextGen results and for replication of the technologies at other sites, different challenges and next steps are outlined in this chapter.

Technologies for material recovery from sludge

The pilot composting reactor demonstrated that reactor-based composting can be down-scaled to a decentralised urban option and still be technically and financially feasible. The ability to produce a high-quality compost in urban settings with no odor and in a small footprint is important to work at a decentralised level. A stand-alone composting reactor unit is needed that is larger than a residential unit, but smaller than a centralized organic waste processing facility. For the replication of the rapid composting bioreactor, a trial and error approach is needed for its sizing, because the mechanical design is dependent on the system scale and composition as well as on the size of its input material. Until now, established models for solid-phased metabolic reactors are rarely available. Therefore, more research should be conducted in terms of solid-phase reactor modelling in order to allow for an easy upscale of this reactor type.

GAC production from sewage sludge was successfully shown. However, for the GAC production from sewage sludge and other materials at other sites, preliminary investigations are mandatory to assess the best conditions for the pyrolysis process and the activation of its product. In addition, a further optimisation of process parameters of the GAC-filters is crucial for prior to its replication, because standard operating conditions do not necessarily apply and always depend on the conditions on site.

The same is true for the pyrolysis process applied for the case study in Timișoara. Here, the tests were run at a test plant. Up-scaling those results is quite challenging. Furthermore, the implementation of a full-scale pyrolysis plant to cover the whole Timis county is a big investment project. Therefore, a detailed planning will be conducted and further feasibility studies are ongoing.

Protein production

The cultivation of purple bacteria as protein source was successfully shown. The main challenge for the replication of the photobioreactor at other sites, is the low TRL between 5 and 6 indicating a further demand for research and optimisation. The aim of this optimisation is to identify the minimum and maximum wastewater concentration and characterisation that will define the need of pre- and post-treatment technologies. A model needs to be created that can be used to scale-up the design for a full-scale implementation.



Also the establishment of a market for the proteins as slow release fertiliser, fodder additive or even as food additive has to be promoted. Hereby, the feed stream of the technology will be crucial for the decision of which quality the endproduct will be. Research activities are still necessary to determine the application rate of the fertiliser and its application method, biomass stability and post processing and the most cost effective way to use it from harvest to application.

Nitrogen recovery

Especially for the nitrogen recovery plants with lower TRLs (5-8) such as for the HFMC, its scale-up is still under scrutiny. The experiences of a first handful of plants that have been constructed and operated should therefore be summarised, evaluated and generalised in order to generate a better basis for its up-scaling.

In terms of the ion exchanger, its media is currently facing supply chain issues and hence, new materials are being tested. The short-term trials indicated that the concentration process would benefit from more cycles in order to facilitate recovery. Hence, more investigations are beneficial to provide more insights of the process for a successful replication.

Regarding the replication of the air stripping and scrubbing process, it is highly recommended to test and investigate before its implementation, if the influent stream is prone to scaling in order to avoid any process failures and downtimes. Several pre-treatments are available and can be combined with this technology such as struvite production as in the case of Braunschweig. Furthermore, if excess heat is available at a potential replication site, it is beneficial to reuse it for the stripping process in order to allow the process to be operated at a lower pH and thus, reduce the demand for NaOH. In general this process is mature and very robust and well suited for replication. In this case, especially waste and wastewater streams with high nitrogen contents are suitable for the treatment with this technology. Therefore, potential replication sites might be industrial waste(water) treatment plants from the meat industry, plant oil industry as well as from breweries as shown in Kleyböcker et al. 2020.

In general, a successful replication might be accelerated, if a market for renewable fertilisers which were recovered from municipal wastewaters would be established and/or developed. Especially wastewater treatment plant operators are not experts in the fertiliser industry and cannot compete with their relatively small amounts of fertilisers on the market compared to the big fertiliser industries. Therefore, a solution should be found as suggested in chapter 7.4.

Phosphorus recovery

For the replication of the struvite recovery plant, preliminary investigation are needed. It is very difficult to predict, how good the crystallisation process works for a certain influent as it was shown in Braunschweig, where the optimisation phase quite far evolved, however, it is still after two years of operation not completed.

As already mentioned for the nitrogen based fertilisers, also for the phosphorus based fertilisers, a market is needed and the plant operator or owner who is usually an expert in wastewater treatment does not have the expertise of trading and marketing the produced fertiliser. In this regard, further recommendations are provided in chapter 7.4.

As for struvite for example, the fertiliser quality was shown to be very high compared to the legal requirements and hence, it would be well suited to be used in organic farming. Therefore, we suggest to amend the regulation on organic production and labelling of organic



products (EC) No 889/2008 and to include struvite recovered from wastewater as a fertiliser for organic farming.

For the phosphorus recovery technologies with lower TRLs (6-7) such as the production of the PK-fertiliser, the extension of the operating time in pilot scale is still needed before its replication to reach a complete steady state under a controlled variation of temperature. A pilot operation with a substrate containing less heavy metals such as meat flour should be preferred to make sure to fulfill the strict requirements of the Swiss fertiliser regulation.

Also other waste and wastewater streams might be of interest for this technology as already outlined before as long as its content is not contaminated with heavy metals such as waste and wastewaters from the meat and plant oil industry as well as from breweries as explained in detail in Kleyböcker et al. 2020.

In terms of the hydroxyapatite production shown in the Sernal case study, still more investigations are needed to for example characterise the organics contained in the influent stream which have an impact on the adsorption capacity of the hybrid anion exchange nanotechnology (HAIX) to optimise the removal and prevent the fouling of the resin. In addition, the short-term trials indicated that the process would benefit from more cycles. Thus, a longer optimisation phase will be beneficial to suggest an optimised process for a potential replication.

Selection of NextGen technologies that might be implemented in Filton Airfield

The NextGen solutions cover centralised and decentralised material recovery technologies. Filton Airfield focused on nutrient recovery potential at district level to simultaneously explore the impact of wastewater volume on nutrient concentrations in wastewater and provide insight into a sustainable water-nutrient circular solution. In this context, decentralised NextGen recovery technologies can be a more favourable way of ensuring the servicing nutrient recovery in the Filton area.

Among NextGen nutrient recovery technologies, the ion exchanger and the hollow fibre membrane contactors demonstrated in Sernal (UK) can be the most appropriate and sustainable solution to be applied to Filton Airfield. This is because the system is suited to be a decentralised system (i.e., local level) and the source of nutrient recovery considered for the Filton case is wastewater from residential buildings that are located close to each other. In addition, the treatment train has an ammonium and phosphate accumulation step using the ion exchanger. Hence, the already increased concentrations are beneficial for this treatment train.

Furthermore, there are NextGen technologies that recover nutrients from sewage sludge as shown in Figure 91. However, only the rapid composting bioreactor demonstrated in Athens (Greece) is suited to be applied in a decentralised system. From the perspective of a system scale, an RCB system would be also considered a sustainable solution to improving circularity in Filton Airfield. However, since the waste source is sewage sludge, it is important to conduct further investigation to evaluate the feasibility of sewage sludge properties with reference to the nutrient recovery. This indicates that when considering the RCB system for the Filton case, the nitrogen and phosphorous contents in sewage sludge generated within the Filton area should be pre-investigated via conducting the mass balances (availability). Furthermore, as demonstrated in Athens, prior to the RCB system, a sewer mining unit was performed as a pre-treatment process to thicken the sludge (i.e., the dry solids content of excess sludge should be at least 5%). As such, the appropriate pre-treatment for influent wastewater should



be pre-determined as it has direct impacts on sludge properties, system maintenance and overall recovery efficiency. Thus, the RCB system would be the second option that might be implemented for the Filton case.

It has to be noted here that NextGen technologies that are centralised and utilise other sources (i.e., industrial wastewater or urine) would not be feasible for the Filton case due to the scope of the current Filton study. However, this would become a feasible solution if the scope of the Filton case study is extended to include a centralised wastewater treatment plant with a nutrient recovery technology being incorporated in the sludge line i.e., thermal treatment and pyrolysis.

7.4 Recommendations for future implementations

As already outlined in chapter 7.3, for most of the processes, preliminary investigations should be done before their implementation especially to consider the individually different conditions and characteristics of their potential waste and wastewater streams for a certain site. Also, some of the investigated technologies still have further optimisation potential and thus, having more demonstration scale trials in small, medium and large WWTPs to show their economic benefits due to a lower energy demand, lower GHG emissions, nutrient/material recovery and higher effluent qualities against costs and maintenance needs might easily convince new investors.

Especially for the technologies with TRL 6 and below, such as the photobioreactor, open questions are still rendering the technology not mature enough for direct commercialisation, so a funding scheme from EU, ESA or other sources for research and development will highly contribute to accelerating the next steps towards its integration at full scale in order to demonstrate the system and thus creating more sales opportunities.

Furthermore, the implementation of all NextGen technologies will be accelerated, if there are pressures from regulation and governments to implement nutrient resource recovery technologies, as there are not many options available until now for example for recovering nutrients in a mainstream configuration. Therefore, legislation could be used to create incentives for the technology use and to set environmental standards to push for the new technologies for example to reduce or even avoid direct GHG emissions from biological treatment processes.

Compared to the fertiliser industry, most of the nutrient recovery plants in circular economy are small and decentralised. They do not have the logistics and legal knowledge (REACH (EC 1907/2006) and certification procedures) to bring their fertilisers profitable to the market. Especially the legal capacities are important, because the Fertilising Products Regulation (EU 2019/1009) does not include products originating from sewage sludge or wastewater, except for struvite and other precipitated phosphate salts (EU 2021/2086), until now. This means ammonium sulphate, compost and biochar, all originating from sewage sludge or wastewater are not explicitly mentioned in the regulation. Due to the small amounts, local or regional markets are more relevant for the marketing of recovered nutrients or renewable fertilisers. For domestic markets, the national legislation can be applied, if it considers those renewable fertilisers. Hence, the legal knowledge is crucial and the inclusion of all renewable fertilisers originating from sewage sludge and/or wastewater in the Fertilising Products Regulation (EU



2019/1009) decreases formal barriers and increases the motivation to invest in such a technology.

We showed that the renewable fertilisers such as struvite and ammonium sulphate have a high quality that is usually required for organic farming. Hence, if the regulation on organic farming and labelling of organic products (EC 889/2008) would include for example struvite in order to label it as a “green” fertiliser, it might compete better with the common fertilisers from the fertiliser industry.

For the PK-fertiliser, it should be noted that as in the case of Altenrhein, the type of the inflow streams is crucial to produce a contaminant-free fertiliser. Also, considering the case of Braunschweig, where the sulfuric acid contributed to a higher mercury concentration in the ammonium sulphate solution shows that the contamination can result from another sources than from the recovered ammonia. Hence, the NextGen technologies are able to produce high quality fertilisers, but nevertheless a quality check of the fertilisers is highly recommended. Regarding the label “green”, here it is crucial to assess the CO₂ footprint of the treatment train to recover the certain material. As shown in D2.1 (Remy et al. 2022), circular economy technologies are not always automatically CO₂ neutral. However, in combination with green energies and the reduction or even avoidance of direct GHG emission via a nitrogen recovery technology, this requirement can be easily reached.

Even though the technologies to recover materials, their suppliers and also their potential clients from the water sector exist, it should be noted, that the primary goal of the water sector is to provide a better water quality and secondly, to reduce their CO₂ emissions. To produce a new product and to bring it to the market is not their priority. Therefore, we need an entity/commercial company that processes the residual towards a usable resource or a product. It seems difficult to find entities that step into a relatively high risk new value chain with a lot of uncertainties. Hence, traditional companies usually step out, because of a competition with their core business and water companies will not invest in value chains, because it is out of their field of treating water. Thus, there is a gap regarding the production of an end product and its marketing. Between a fertiliser producer and a farmer, there act usually trading companies. They might have an advantage, when they blend the renewable fertilisers with the “traditional fertilisers”.



8. Literature references

- AbwV (2022). Verordnung über Anforderungen an das Einleiten von Abwasser in Gewässer (Abwasserverordnung – AbwV vom 17. Juni 2004 BGBl. I S.1108, 2625 und vom 20. Januar 2022 BGBl. I S. 87). Bundesministerium der Justiz und Bundesamt für Justiz. <http://www.gesetze-im-internet.de/abwv/AbwV.pdf>
- Agricultural Research Service (2019). What is pyrolysis? Biomass Pyrolysis Research at the Eastern Regional Research Center, U.S. Department of Agriculture. <https://www.ars.usda.gov/northeast-area/wyndmoor-pa/eastern-regional-research-center/docs/biomass-pyrolysis-research-1/what-is-pyrolysis/> assessed on 14.09.2022
- Ajmal, M., Aiping, S., Uddin, S. *et al.* A review on mathematical modeling of in-vessel composting process and energy balance. *Biomass Conv. Bioref.* 12, 4201–4213 (2022). <https://doi.org/10.1007/s13399-020-00883-y>
- Alloul, A., Cerruti, M., Adamczyk, D., Weissbrodt, D., Vlaeminck, E. (2021a). Operational strategies to selectively produce purple bacteria for microbial protein in raceway reactors. *Environmental Science & Technology*, 55, 12, 8278-8286. <https://doi.org/10.1021/acs.est.0c08204>
- Alloul, A., Ganigué, R., Spiller, M., Meerburg, F., Cagnetta, C., Rabaey, K., Vlaeminck, S. (2018). Capture–Ferment–Upgrade: A Three-Step Approach for the Valorization of Sewage Organics as Commodities
- Alloul, A., Gardella, G., Cerruti, M., Vlaeminck, S., Abraham, E., Lindeboom, R., Weissbrodt D. (2021b). In A mechanistic model for purple bacteria in raceway reactors: Simulating microbial selection and wastewater treatment performance, 4th IWA Resource Recovery Conference.
- Alloul, A., Wuyts, S., Lebeer, S., Vlaeminck, S. (2019). Volatile fatty acids impacting phototrophic growth kinetics of purple bacteria: Paving the way for protein production on fermented wastewater, *Water Research* 152, 138–147.
- Anumol, T., Sgroi, M., Park, M., Roccaro, P., Snyder, S.A., 2015. Predicting trace organic compound breakthrough in granular activated carbon using fluorescence and UV absorbance as surrogates. *Water Research* 76, 76–87. <https://doi.org/10.1016/j.watres.2015.02.019>
- Aslam, A., Khan, S. J., Shahzad, H. M. A. (2022). Anaerobic membrane bioreactors (AnMBRs) for municipal wastewater treatment-potential benefits, constraints, and future perspectives: An updated review. *Science of the total Environment*, 802, 149612.
- Bailey, O., Zlatanovic, L., van der Hoek, J.P., Kapelan, Z., Blokker, M., Arnot, T., Hofman, J. 2020. A Stochastic Model to Predict Flow, Nutrient and Temperature Changes in a Sewer under Water Conservation Scenarios. *Water*, 12(4), 1187.
- Benstoem, F., Pinnekamp, J., 2017. Characteristic numbers of granular activated carbon for the elimination of micropollutants from effluents of municipal wastewater treatment plants. *Water Science and Technology* 76, 279–285. <https://doi.org/10.2166/wst.2017.199>
- Blokker, E.J.M. 2010. Stochastic water demand modelling for a better understanding of hydraulics in water distribution networks.
- Böhler, M., Büttner, S., Liebi, C., Siegrist, H. (2012). Ammoniakstrippung mittels Luft zur Behandlung von Faulwasser und Urin auf der auf der Kläranlage Kloten/Opfikon. *Aqua & Gas*, 1, 1-7. <https://doi.org/10.2166/wst.2009.045>



- Böhler M., Hernandez A., Fleiner J., Gruber W., Seyfried A. (2015): Powerstep D4.3 Operation and optimization of membrane ammonia stripping.
- Bunce, J.T., Ndam, E., Ofiteru, I.D., Moore, A., Graham, D.W. 2018. A review of phosphorus removal technologies and their applicability to small-scale domestic wastewater treatment systems. *Frontiers in Environmental Science*, **6**, 8.
- Carrillo, V., Fuentes, B., Gómez, G., Vidal, G. 2020. Characterization and recovery of phosphorus from wastewater by combined technologies. *Reviews in Environmental Science and Bio/Technology*, **19**(2), 389-418.
- CC 814.201 Waters Protection Ordinance of 28 October 1998 (WPO) [WWW Document], 2020. <https://www.admin.ch/opc/en/classified-compilation/19983281/index.html> (accessed on 4.9.20).
- City of Athens (2017). Redefining the city: Athens Resilience Strategy for 2023. https://resilientathens.files.wordpress.com/2017/07/athens_resilience_strategy_-_reduced_pdf-compressed.pdf accessed on Nov. 10th 2022.
- Cornel, P., Schaum, C. (2009). Phosphorus recovery from wastewater: needs, techniques and costs. *Water Science and Technology*, **59**, 1069–1076. <https://doi.org/10.2166/wst.2009.045>
- Crittenden, J.C., Trussel, R.R., Hand, D.W., Howe, K.J., Tchobanoglous, G., 2012. *MWH's Water Treatment: Principles and Design*, Third Edition 1919.
- Daschner, R. (2022). TCR technology: CO₂-neutral energy sources from biogenic waste. Department Renewable Energy. Fraunhofer Umsicht. https://www.umsicht-suro.fraunhofer.de/en/Our_Solution/tcr-technology.html assessed on 14.09.2022
- Desmidt, E., Ghyselbrecht, K., Zhang, Y., Pinoy, van der Bruggen, B., Verstraete, W., Rabaey, K., Meesschaert, B. (2015). Global phosphorus scarcity and full-scale P-recovery techniques, *Critical Reviews in Environmental Science and Technology*, **45**, 336-384. <https://doi.org/10.1080/10643389.2013.866531>
- Diaz-Elsayed, N., Rezaei, N., Guo, T., Mohebbi, S., Zhang, Q. 2019. Wastewater-based resource recovery technologies across scale: a review. *Resources, Conservation and Recycling*, **145**, 94-112.
- DüMV (2012). Verordnung über das Inverkehrbringen von Düngemitteln, Bodenhilfsstoffen, Kultursubstraten und Pflanzenhilfsmitteln (Düngemittelverordnung – DüMV vom 5. Dezember 2012, BGBl. I S. 2482), Bundesministerium der Justiz und Bundesamt für Justiz. https://www.gesetze-im-internet.de/d_mv_2012/D%C3%BCMV.pdf
- Elmously, M., Jäger, N., Neidel, J., Apfelbacher, A., Daschner, R., Hornung, A. (2019). Upscaling of thermo-catalytic reforming process from lab to pilot scale. *Ind. Eng. Chem. Res.*, **58**, 35, 15853-15862. <https://doi.org/10.1021/acs.iecr.9b00765>
- EC (889/2008) Commission Regulation of 5 September 2008 laying down detailed rules for the implementation of Council Regulation (EC) no. 834/2007 on organic production and labelling of organic products with regard to organic production, labelling and control <https://eur-lex.europa.eu/legal-content/EN/TXT/?uri=CELEX:32008R0889> accessed on Sept. 16th 2022
- EC (1907/2006) Regulation of the European Parliament and of the Council of 18 December 2006 concerning the Registration, Evaluation, Authorisation and Restriction of Chemicals (REACH), establishing a European Chemicals Agency, amending Directive 1999/45/EC and repealing Council Regulation (EEC) No 793/93 and Commission Regulation (EC) No 1488/94 as well as Council Directive 76/769/EEC and Commission Directives 91/155/EEC, 93/67/EEC, 93/105/EC and 2000/21/EC <https://eur-lex.europa.eu/legal->



- content/EN/TXT/?uri=CELEX%3A32006R1907&qid=1665136714271, accessed on Oct. 7th 2022
- EU (2019/1009) Regulation of the European Parliament and of the Council of 5 June 2019 laying down rules on the making available on the market of EU fertilising products and amending Regulations (EC) No 1069/2009 and (EC) No 1107/2009 and repealing Regulation (EC) No 2003/2003 <https://eur-lex.europa.eu/legal-content/EN/TXT/?uri=celex%3A32019R1009> accessed on Oct. 7th 2022.
- EU (2020/2096) Commission Regulation of 15 December 2020 amending Annex XVII to Regulation (EC) No 1907/2006 of the European Parliament and of the Council concerning the Registration, Evaluation, Authorisation and Restriction of Chemicals (REACH), as regards carcinogenic, mutagenic or reproductive toxicant (CMR) substances, devices covered by Regulation (EU) 2017/745 of the European Parliament and of the Council, persistent organic pollutants, certain liquid substances or mixtures, nonylphenol and testing methods for azocolourants <https://eur-lex.europa.eu/eli/reg/2020/2096/oj> accessed on Oct. 7th 2022
- EU (2021/2086) Commission Delegated Regulation of 5 July 2021 amending Annexes II and IV to Regulation (EU) 2019/1009 of the European Parliament and of the Council for the purpose of adding precipitated phosphate salts and derivatives as a component material category in EU fertilising products, <https://eur-lex.europa.eu/legal-content/EN/TXT/?uri=CELEX%3A32021R2086&qid=1665136891038> accessed on Oct. 7th 2022
- Feachem, R.G., Bradley, D.J., Garelick, H., Mara, D.D. 1980. Health aspects of excreta and sullage management--a state-of-the-art review. *Health aspects of excreta and sullage management--a state-of-the-art review*.
- Founda, D., Katavoutas, G., Pierros, F., Mihalopoulos, N. (2022). The extreme heat wave of summer 2021 in Athens (Greece): cumulative heat and exposure to heat stress. *Sustainability*, 14, 7766. <https://doi.org/10.3390/su14137766>
- Gergova, K., Eser, S., 1996. Effects of activation method on the pore structure of activated carbons from apricot stones. *Carbon* 34, 879–888. [https://doi.org/10.1016/0008-6223\(96\)00028-0](https://doi.org/10.1016/0008-6223(96)00028-0)
- Gershuny, J., Sullivan, O. 2017. United Kingdom Time Use Survey, 2014-2015, <http://doi.org/10.5255/UKDA-SN-8128-1>, [data collection]. UK Data Service. SN: 8128.
- Gironás, J., Roesner, L., Rossmann, L., Davis, J. (2010). A new applications manual for the storm water management model (SWMM). *Environmental Modelling & Software*, 25, 813-814.
- Giurgiu, R., Majoor, I., Kenyeres, I., Alloul, A., Lasserre, J., Magnes, P., Plata-Rios, C., Scheer, P., Vlaeminck, S., Suters, R., Koller, I., Lindeboom, R., (2020). From wastewater treatment to space-inspired resource recovery with the Biomakery concept at the La Trappe brewery, MELISSA Conference 2020
- Godia, F., Albiol, J., Montesinos, J., Perez, J., Creus, N., Cabello, F., Mengual, X., Montras, A., Lasseur, C. (2002). MELISSA: a loop of interconnected bioreactors to develop life support in space, *Journal of biotechnology*, 99, 319-330.
- González, C., Fernández, B., Molina, F., Camargo-Valero, M., Peláez, C. (2021). The determination of fertiliser quality of the formed struvite from a WWTP. *Water Science and Technology*. 83, 12, 3041-3053. <https://doi.org/10.2166/wst.2021.162>
- Gouveia, J., Plaza, F., Garralon, G., Fdz-Polanco, F., Peña, M. (2015). Long-term operation of a pilot scale anaerobic membrane bioreactor (AnMBR) for the treatment of municipal wastewater under psychrophilic conditions. *Bioresource Technology*. J. 185, 225–233.



- Gouveia, J., Plaza, F., Garralon, G., Fdz-Polanco, F., Peña, M. (2015b). A novel configuration for an anaerobic submerged membrane bioreactor (AnSMBR), *Bioresource Technology*, 198, 510–519.
- Guida, S., Conzelmann, L., Remy, C., Vale, P., Jefferson, B., Soares, A. (2021). Resilience and life cycle assessment of ion exchange process for ammonium removal from municipal wastewater. *Science of the Total Environment*, 783.
- Guida, S., Potter, C., Jefferson, B., Soares, A. (2020). Preparation and evaluation of zeolites for ammonium removal from municipal wastewater through ion exchange process. *Scientific Reports*, 10(1).
- Guida, S., Rubertelli, G., Jefferson, B., Soares, A. (2021). Demonstration of ion exchange technology for phosphorus removal and recovery from municipal wastewater. *Chemical Engineering Journal*, 420.
- Hadi, P., Xu, M., Ning, C., Sze Ki Lin, C., McKay, G., 2015. A critical review on preparation, characterization and utilization of sludge-derived activated carbons for wastewater treatment. *Chemical Engineering Journal* 260, 895–906.
<https://doi.org/10.1016/j.cej.2014.08.088>
- Hagemann, N., Schmidt, H.-P., Kägi, R., Böhler, M., Sigmund, G., Maccagnan, A., McArdell, C.S., Bucheli, T.D., 2020. Wood-based activated biochar to eliminate organic micropollutants from biologically treated wastewater. *Science of the total Environment* 730, 138417.
<https://doi.org/10.1016/j.scitotenv.2020.138417>
- Hagemann, N., Spokas, K., Schmidt, H.-P., Kägi, R., Böhler, M.A., Bucheli, T.D., 2018. Activated Carbon, Biochar and Charcoal: Linkages and Synergies across Pyrogenic Carbon's ABCs. *Water* 10, 182. <https://doi.org/10.3390/w10020182>
- Heidel, B., Rogge, T., Scheffknecht, G. (2014). Controlled re-emission of mercury in waste water treatment. *Energy Procedia* 61, 2307-2310.
<https://doi.org/10.1016/j.egypro.2014.11.1190>
- Heinze, J. (2022). Own data (personal communication), Abwasserverband Braunschweig.
- Henning, K.-D., von Kienle, H., 2010. Carbon, 5. Activated Carbon, in: Wiley-VCH Verlag GmbH & Co. KGaA (Ed.), *Ullmann's Encyclopedia of Industrial Chemistry*. Wiley-VCH Verlag GmbH & Co. KGaA, Weinheim, Germany, p. n05_n04.
https://doi.org/10.1002/14356007.n05_n04
- Hu, Y., Du, R., Nitta, S., Ji, J., Rong, C., Cai, X., ... & Li, Y. Y. (2021). Identification of sustainable filtration mode of an anaerobic membrane bioreactor for wastewater treatment towards low-fouling operation and efficient bioenergy production. *Journal of Cleaner Production*, 329, 129686.
- Huang, X., Guida, S., Jefferson, B., Soares, A. (2020). Economic evaluation of ion-exchange processes for nutrient removal and recovery from municipal wastewater. *Npj Clean Water*, 3(1).
- Huber, W.C., EPA Storm Water Management Model (SWMM), Versions 4.31 and 4.4. (1997). Department of Civil, Construction, and Environmental Engineering, Oregon.
- Isik, O., Abdelrahman, A.M., Ozgun, H., Ersahin, M.E., Demir, I., Koyuncu, I. (2019). Comparative evaluation of ultrafiltration and dynamic membranes in an aerobic membrane bioreactor for municipal wastewater treatment. *Environmental Science and Pollution Research*, 26(32), 32723-32733.
- Judd, S. (2010). *The MBR Book: Principles and applications of membrane bioreactors in water and wastewater treatment*. 2nd ed., Elsevier.



- Kim, J., Lanham, A., Hunt, A., Hofman, J. (2022). Greenfield implementation in Filton Airfield. D1.8 NextGen Horizon 2020 (GA N°776541).
- Kim, J., Hofman, J., Kenyeres, I., Poor-Pocsi, E., Kleyböcker, A., Heinze, J., Kraus, F., Soares, A., Paissoni, E., Vale, P., Plmer, M., Bloemendal, M., Beernink, S., Ros, S., Hartong, N., Frijns, J. (2022). New approaches and best practices for closing the energy cycle in the water sector. D1.4 NextGen Horizon 2020 (GA N°776541), 140 p.
- Kleyböcker, A., Kim, J., Hofman, J., Serra, A., Casas, S. (2019). Assessment of baseline conditions for all case studies. D1.1 NextGen Horizon 2020 (GA N°776541), 44 p.
- Kleyböcker, A., Kraus, F., Moermann, W., Pudova, N., Holba, M., Dünnebeil, A. (2020). Efficient carbon, nitrogen and phosphorus cycling in the European agri-food system and related up- und down-stream processes to mitigate emissions, Circular Agronomics, D3.1, Grant Agreement Number 773649. <https://www.circularagronomics.eu/wp-content/uploads/CA-D3.1-E-0820-Classification-streams.pdf>
- Kleyböcker, A., Heinze, J., Kraus, F. (2022): Enhancing biogas production via a thermal pressure hydrolysis in Kim et al. (2022). New approaches and best practices for closing the energy cycle in the water sector, D1.4 NextGen Grant Agreement No 776541.
- Kleyböcker, A., Plana Puig, Q., Kim, J. Hofman, J. (2022). Technology Evidence Base final version. D1.7 (GA N°776541), 27 p.
- Kong, Z., Li, L., Wu, J., Wang, T., Rong, C., Luo, Z., Pan, Y., Li, D., Li, Y., Huang, Y., Li, Y. (2021). Evaluation of bio-energy recovery from the anaerobic treatment of municipal wastewater by a pilot-scale submerged anaerobic membrane bioreactor (AnMBR) at ambient temperature. *Bioresource Technology*, Vol. 339, 125551.
- Krahnstöver, T., Plattner, J., Wintgens, T., 2016. Quantitative detection of powdered activated carbon in wastewater treatment plant effluent by thermogravimetric analysis (TGA). *Water Res* 101, 510–518. <https://doi.org/10.1016/j.watres.2016.06.008>
- Kratz, S., Vogel, C., Adam, C. (2019). Agronomic performance of P recycling fertilizers and methods to predict it: a review, *Nutrient Cycling in Agroecosystems*, 115, 1-39. DOI: <https://doi.org/10.1007/s10705-019-10010-7>
- Lasseur, C., Brunet, J., De Weever, H., Dixon, M., Dussap, G., Godia, F., Leys, N., Mergeay, M., Van Der Straeten, D. (2011). MELiSSA: the European project of closed life support system, *Gravitational and Space Research*, 23.
- Lee, Y., Gerrity, D., Lee, M., Bogeat, A.E., Salhi, E., Gamage, S., Trenholm, R.A., Wert, E.C., Snyder, S.A., von Gunten, U., 2013. Prediction of Micropollutant Elimination during Ozonation of Municipal Wastewater Effluents: Use of Kinetic and Water Specific Information. *Environ. Sci. Technol.* 47, 5872–5881. <https://doi.org/10.1021/es400781r>
- Lee, Y., Kovalova, L., McArdell, C.S., von Gunten, U., 2014. Prediction of micropollutant elimination during ozonation of a hospital wastewater effluent. *Water Research* 64, 134–148. <https://doi.org/10.1016/j.watres.2014.06.027>
- Longo, S., D’Antoni, B.M., Bongards, M., Chaparro, A., Cronrath, A., Fatone, F., Lema, J., M., Mauricio-Iglesias, M., Soares, A., Hospido, A., (2016). Monitoring and diagnosis of energy consumption in wastewater treatment plants. A state of the art and proposals for improvement. *Appl. Energy* 179, 1251–1268.
- Lorreggian, L. (2021) Results from NextGen GAC technology demonstration.
- Martin Garcia, I. M., Mocosch, M., Soares, A., Pidou, M., Jefferson, B. (2013). Impact on reactor configuration on the performance of anaerobic MBRs: treatment of settled sewage in temperate climates. *Water research*, 47(14), 4853-4860.



- Martin, I., Pidou, M., Soares, A., Judd, S., Jefferson, B. (2011). Modelling the energy demands of aerobic and anaerobic membrane bioreactors for wastewater treatment. *Environmental technology*, Vol. 32, No. 9, 921–932.
- Metcalfe & Eddy, Inc., Tchobanoglous, G., Stensel, H., Tsuchihashi, R. Burton, F. (2013). *Wastewater Engineering: Treatment and Resource Recovery*, Fifth Edition, McGraw-Hill Education, New York, 2018 p. ISBN 978-0-07-340118-8
- Nätörp, A., Misev, V. (2022). Economic assessment and cost efficiency analysis of NextGen demo case solutions, D2.2 NextGen Grant Agreement Number 776541, 87 p.
- Muhammad, A., Soares, A., & Jefferson, B. (2019). The impact of background wastewater constituents on the selectivity and capacity of a hybrid ion exchange resin for phosphorus removal from wastewater. *Chemosphere*, 224, 494–501.
- Muy, M., Phukana, R., Brader, G., Samad, A., Moretti, M., Haiden, B., Pluchonc, S., Roeste, K., Vlaeminck, S., Spiller, M. (2021). A systematic comparison of commercially produced struvite: Quantities, qualities and soil-maize phosphorus availability. *Science of the total Environment*, 56, 143726, 1-12.
<https://doi.org/10.1016/j.scitotenv.2020.143726>
- NuReSys 2020: <http://www.nuresys.be/references.html> (accessed on 2020-12-14)
- Rao, A., Reddy, T., Prakash, S., Vanajakshi, J., Joseph, J., Sarma, P. (2007). pH regulation of alkaline wastewater with carbon dioxide: a case study of treatment of brewery wastewater in UASB reactor coupled with absorber, *Bioresource technology*, 98, 2131-2136.
- Remy, C., Kraus, F., Conzelmann, L., Seis, W., Zamzow, M. (2022). Environmental life cycle assessment and risk analysis of NextGen demo case solutions. D2.1 NextGen Grant Agreement Number 776541, 195 p.
- Paissoni, E., Sakar, H., Vale, P., Pitt, S., Smith, R., Jefferson, B., Soares, A. (2022). Demonstration-scale anaerobic membrane bioreactor and degassing unit for resource recovery in temperate climates. 17th IWA World Conference on Anaerobic Digestion, Ann Arbor, MI, United States.
- Park, N., Chang, H., Jang, Y., Lim, H., Jung, J., Kim, W. (2020). Critical conditions of struvite growth and recovery using MgO in pilot scale crystallization plant. *Water, Science and Technology*, 81, 12, 2511-2521. <https://doi.org/10.2166/wst.2020.306>
- Pelekani, C., Snoeyink, V.L., 2000. Competitive adsorption between atrazine and methylene blue on activated carbon: the importance of pore size distribution. *Carbon* 38, 1423–1436. [https://doi.org/10.1016/S0008-6223\(99\)00261-4](https://doi.org/10.1016/S0008-6223(99)00261-4)
- Pinelli, D., Bovina, S., Rubertelli, G., Martinelli, A., Guida, S., Soares, A., Frascari, D. (2022). Regeneration and modelling of a phosphorous removal and recovery hybrid ion exchange resin after long term operation with municipal wastewater. *Chemosphere*, 286.
- Plaza, M.G., González, A.S., Pis, J.J., Rubiera, F., Pevida, C., 2014. Production of microporous biochars by single-step oxidation: Effect of activation conditions on CO2 capture. *Applied Energy* 114, 551–562. <https://doi.org/10.1016/j.apenergy.2013.09.058>
- Pocernich, M., Litke, D.W. 1997. Nutrient concentrations in wastewater treatment plant effluents, south platte river basin 1. *JAWRA Journal of the American Water Resources Association*, 33(1), 205-214.
- Prazeres, A., Carvalho, F., Rivas, J. (2012). Cheese whey management: a review, *Journal of Environmental Management*, 110, 48-68.



- Puyol, D., Barry, E., Hülsen, T., Batstone, D. (2017). A mechanistic model for anaerobic phototrophs in domestic wastewater applications: Photo-anaerobic model (PANM). *Water Research*, 116, 241-253. <https://doi.org/10.1016/j.watres.2017.03.022>
- Rahman, M., Salleh, M., Rashid, U., Ahsan, A., Hossain, M., Ra, C. (2014). Production of slow release crystal fertilizer from wastewaters through struvite crystallization – A review. *Arabian Journal of Chemistry*, 7, 139-155. <http://dx.doi.org/10.1016/j.arabjc.2013.10.007>
- Research, W.U.a. 2022. Recovering nutrients from waste water, Vol. 2022.
- Ribera-Pi, J., Campitelli, A., Badia-Fabregat, M., Jubany, I., Martinez-Llado, X., McAdam, E., Jefferson, B., Soares, A. (2020). Hydrolysis and methanogenesis in UASB-AnMBR treating municipal wastewater under psychrophilic conditions: Importance of reactor configuration and inoculum. *Frontiers in Bioengineering and Biotechnology*, 8, 1-14.
- Robles, A., Ruano, M. V., García-Usach, F., Ferrer, J. (2012). Sub-critical filtration conditions of commercial hollow-fibre membranes in a submerged anaerobic MBR (HF-SAnMBR) system: the effect of gas sparging intensity. *Bioresource Technology*, 114, 247-254.
- Rodriguez-Reinoso, F., Martin-Martinez, J., Prado-Burguete, C., McEnaney, B. (1987). A standard adsorption isotherm for the characterization of activated carbons. *J. Phys. Chem.* 91, 515–516. <https://doi.org/10.1021/j100287a006>
- Sengupta, S., Nawaz, T., Beaudry, J. (2015). Nitrogen and Phosphorus recovery from wastewater. *Curr Pollution Rep*, 1, 155-166. <https://doi.org/10.1007/s40726-015-0013-1>
- Shaddel, S., Ucar, S., Andreassen, J., Østerhus, S. (2019). Engineering of struvite crystals by regulating supersaturation – Correlation with phosphorus recovery, crystal morphology and process efficiency. *Journal of Environmental Chemical Engineering*, 7, 102918. <https://doi.org/10.1016/j.jece.2019.102918>
- Shin, C., McCarty, P. L., Kim, J., Bae, J. (2014). Pilot-scale temperate climate treatment of domestic wastewater with a staged anaerobic fluidized membrane bioreactor (SAF-MBR). *Bioresource Technology*, 159, 95–103.
- Siatou, A., Manali, A., Gikas, P. (2020). Energy Consumption and Internal Distribution in Activated Sludge Wastewater Treatment Plants of Greece. *Water*, 12, 1204.
- Simate, G., Cluett, J., Lyuke, S., Musapatika, E., Ndlovu, S., Walubita, L., Alvarez, A. (2011). The treatment of brewery wastewater for reuse: State of the art, *Desalination*, 273, 235-247.
- Statistics, O.f.N. 2020. 2011 Census: Aggregate Data, <http://doi.org/10.5257/census/aggregate-2011-2>, UK Data Service.
- Szymańska, M., Sosulski, T., Szara, E., Wąs, A., Sulewski, P., van Puijssen, G., Cornelissen, R. (2019). Ammonium sulphate from a bio-refinery system as a fertilizer - agronomic and economic effectiveness on the farm scale. *Energies*, 12, 4721, 1-15. <https://doi.org/10.3390/en12244721>
- Trémier, A., Teglia, C., Barrington, S. (2009). Effect of initial physical characteristics on sludge compost performance, *Bioresource Technology*, 100, 15, 3751-3758, <https://doi.org/10.1016/j.biortech.2009.01.009>.
- Verrecht, B, Judd, S., Guglielmi, G., Brepols, C., Mulder, J.W. (2008). An aeration energy model for an immersed membrane bioreactor, *Water Res.* 42, 4761–4770.
- Wang, K. M., Jefferson, B., Soares, A., McAdam, E. J. (2018b). Sustaining membrane permeability during unsteady-state operation of anaerobic membrane bioreactors for municipal wastewater treatment following peak-flow. *J. Memb. Sci.* 564, 289–297.



- Wang, K. M., Martin Garcia, N., Soares, A., Jefferson, B., McAdam, E. J. (2018). Comparison of fouling between aerobic and anaerobic MBR treating municipal wastewater. *H2Open Journal* 1(2), 131-159.
- Watson, C., Clemens, J., Wichern, F. (2019). Plant availability of magnesium and phosphorus from struvite with concurrent nitrification inhibitor application. *Soil Use and Management*, 35, 4, 675-682. <https://doi.org/10.1111/sum.12527>
- YTL. 2021. YTL Masterplan, <https://www.brabazon.co.uk/the-hangar-district>
- Zietzschmann, F., Altmann, J., Ruhl, A.S., Dünnbier, U., Dommisch, I., Sperlich, A., Meinel, F., Jekel, M., 2014. Estimating organic micro-pollutant removal potential of activated carbons using UV absorption and carbon characteristics. *Water Research* 56, 48–55. <https://doi.org/10.1016/j.watres.2014.02.044>

