



Research Project:



Project CoDiGreen

Work Package 3:

Results of pilot and full-scale trials
performed in Braunschweig
on codigestion and thermohydrolysis

Dipl.-Geoökol. Daniel Klein

Dipl.-Ing. Karsten Füllung

M. Eng. Robert Mieske

Prof. Dr.-Ing. habil. Thomas Dockhorn

Imprint:

Project CoDiGreen: Work Package 3 – Report on pilot and full-scale trials performed in Braunschweig on codigestion and thermal hydrolysis

Final version, 10.03.2013

Authors¹:

Daniel Klein, ISWW

Karsten Füllung, ISWW

Robert Mieske, ISWW

Thomas Dockhorn, ISWW

Reviewers:

Boris Lesjean, KWB

Christoph Siemers, SE|BS

Braunschweig, December 2011

Research report within the framework of the project CoDiGreen by the Institute of Sanitary and Environmental Engineering, Technische Universität Braunschweig.

CoDiGreen is a project of and coordinated by Kompetenzzentrum Wasser Berlin (KWB). The project is supported financially by Veolia Eau and Berliner Wasserbetriebe (BWB). Furthermore the project was a collaboration with the partners of the Institute of Sanitary and Environmental Engineering of the Technische Universität Braunschweig, the Stadtentwässerung Braunschweig, the Abwasserverband Braunschweig as well as VERI (Veolia Environment Research and Innovation).

¹ Section on « pharmaceuticals analyses » written by Boris Lesjean, KWB, and Louis Castillo and Veronique Boireau, VERI

List of contents

List of Figures	III
List of Tables	IV
1 Introduction	1
1.1 Activities and objectives of the project	1
1.2 Planning and running of the project.....	2
2 Research program of lab-scale trials.....	4
2.1 Preliminary tests	4
2.2 Description of the pilot plant.....	5
2.3 Program of the experimental series	7
2.4 Evaluation of the data from pilot scale reactors.....	10
3 Results of lab-scale trials	14
3.1 Mass balances.....	14
3.2 Kinetics and performance of the biogas production.....	16
3.3 Organic micro pollutants and return loads.....	21
3.3.1 Organic micro pollutants	21
3.3.2 Heavy metals.....	24
3.3.3 Return loads in the sludge liquor.....	26
3.4 Dewaterability of digested sludge	29
4 Research program of full-scale trials.....	32
4.1 Preliminary tests	32
4.2 Set-up of the full-scale trials.....	32
4.3 Analytical program	34
4.4 Data evaluation.....	35
4.5 Operational procedures during full-scale trials	36
4.5.1 Harvest and silage of grass	36
4.5.2 Feeding and operation of the digester towers	36
5 Results of full-scale trials	38

5.1	Mass balances.....	38
5.2	Performance of the biogas production	39
5.3	Organic pollutants and return loads	42
5.3.1	Organic micropollutants	42
5.3.2	Heavy metals.....	42
5.3.3	Return loads	43
5.4	Dewaterability of digested sludge	44
6	Summary and outlook.....	45
7	Annex	49
7.1	Heavy metals.....	49
7.2	Analytical protocol for the analysis of persistent organic micropollutants.....	49
7.3	References	51

List of Figures

Figure 2-1: Results of the preliminary anaerobic batch tests. Specific gas yield of batch tests with variations of co-digestion and THP.	4
Figure 2-2: Anaerobic reactors in lab scale.	5
Figure 2-3: Basic diagram of the lab-scale reactor.	5
Figure 2-4: THP-plant in laboratory scale.	6
Figure 2-5: Control unit of the THP.	6
Figure 2-6: Basic diagram of the THP in laboratory scale.	6
Figure 2-7: Measuring system for the gas yield detection.	7
Figure 2-8: Measuring and control unit.	7
Figure 2-9: Ensiled grass harvested in the irrigation fields.	9
Figure 2-10: Topinambur (ensiled) harvested in the irrigation fields.	9
Figure 2-11: Basic diagram of the DLD-configuration.	10
Figure 2-12: COD-Mass Balance of reactor R1 in IMP-II.	11
Figure 2-13: Performance of the specific gas production of the reference reactor R1.	12
Figure 3-1: Biogas kinetics of the cumulative specific biogas yield of the reactors in IMP-I.	16
Figure 3-2: Performance of the specific biogas yield of the DLD-configuration.	18
Figure 3-3: Measured concentrations of PAH in the spiking test with concentrations above the limit of quantification in both samples and the expected concentrations.	22
Figure 3-4: COD _s concentrations in the sludge liquor of the pilot scale reactors in IMP-II.	27
Figure 3-5: CODs-degradation of the reference and the sludge liquor from the reactors in IMP-II.	28
Figure 3-6: Types of water in sewage sludge [Kopp, J.; 2001].	29
Figure 3-7: Drying rate and TR(A) of digested sludge with a hydraulic retention time of 12 days (R2: DLD- I).	30
Figure 3-8: Dewaterability of the digested sludge in IMP- I and IMP- II.	30
Figure 4-1: Schematic overview on the set-up of the trials and relevant sampling points.	33
Figure 4-2: Ratio of ensiled grass in digester tower 1 (related to TS of the sludge).	34
Figure 4-3: Size of the ensiled grass.	36
Figure 4-4: Quickmix and mixer feeder on the WWTP of Braunschweig.	37

Figure 5-1: Gas yield [NL/kg VS _{added}] of the three digester towers during the IMP.	40
Figure 5-2: Results of the thermo gravimetric analysis (TR(A)-values).....	44

List of Tables

Table 2-1: Overview on the analysed parameters during the IMP.	8
Table 2-2: Overview on the Experimental Series IMP- I and IMP-II.	9
Table 3-1: COD mass balances of the pilot scale reactors.	14
Table 3-2: Survey of differences in the mass balances over the Intensive monitoring program.	15
Table 3-3: Results of the mass balances of volatile and total solids.....	15
Table 3-4: Overview on the specific gas yield and the increase by co-digestion and TDH in IMP-I.	19
Table 3-5: Overview of the specific gas yield and the increase by co-digestion and TDH in IMP-II.	20
Table 3-6: Increase of the specific gas yield and the specific methane yield and VS-degradation for the pilot scale reactors related to the reference reactors.	20
Table 3-7: Analysis of organic micro pollutants.....	21
Table 3-8: Concentrations of NP, DEHP and total PAH in digested sludge within the spiking test..	22
Table 3-9: Analysis of dioxin, furan and PCB in IMP-I.....	23
Table 3-10: Concentration of heavy metals in the digested sludge, limit values according to the sewage sludge ordinance 2012 and concentration of P ₂ O ₅ in the digested sludge.....	25
Table 3-11: Concentrations of dissolved heavy metals in the steps of the DLD-configuration.	25
Table 3-12: Return loads of COD _s , N and P after dewatering of sludge and percentage of return loads related to average influent loads of the Braunschweig WWTP.	26
Table 3-13: Average COD _s in sludge liquor, degradability of COD _s determined by a modified Zahn-Wellens test, resulting refractory dissolved COD in sludge liquor and effluent of Braunschweig WWTP.....	28
Table 4-1: Properties and quantities of sludge and co-substrates used in full-scale.	32
Table 4-2: Relevant operational parameters of the three digester towers during the IMP.....	33
Table 4-3: Analytical program of the full-scale trials; routine and special analyses.	35
Table 5-1: COD-Mass balances of the full-scale reactors (all values in [t]).	38
Table 5-2: Mass balances of the parameters COD, TC, TKN and P.....	38

Table 5-3: Results of the mass balances of volatile- (VS) and total solids (TS) during the IMP.	39
Table 5-4: Organic acids (as acetic acid equiv.) in the three digester towers; measured 2x/week.	40
Table 5-5: Specific gas yield and influence of co-substrates on the gas yield.	41
Table 5-6: Results of the analysis of organic micropollutants.	42
Table 5-7: Mean concentrations of heavy metals in the three digester towers and in ensiled grass.	43
Table 5-8: Concentrations of COD _s , NH ₄ -N and PO ₄ -P in the liquid phase.	43
Table 6-1: Main differences between lab- and full-scale trials; and potential impacts on the results observed.	46

1 Introduction

The high energy demand of Wastewater Treatment Plants (WWTP) is challenging engineers to optimize single process steps in order to enhance the energy efficiency of the plants. On the one hand, recent research aims to improve the energetic effectiveness of the WWTPs, on the other hand there are options to increase the energy production during the anaerobic sludge stabilization.

The objective of this research project was to quantify the impact of co-digestion and the thermal hydrolysis process (THP) on the biogas yield and the degradation of volatile solids. Furthermore, properties of the digested sludge and the return loads from sludge liquor were investigated.

Braunschweig is particularly suited for these investigations, because fallow lands to grow energy crops are available on the former sewage fields, thus providing a constant source for co-substrates. Moreover, nutrient cycles could be closed by returning this substrate via the wastewater- and sludge treatment system to the agricultural irrigation area.

The project team of "CoDiGreen" consists of the Institute of Sanitary and Environmental Engineering, Technische Universität Braunschweig in cooperation with the Kompetenzzentrum Wasser Berlin. Collaboration partners are Veolia Eau (Sponsor), Berliner Wasserbetriebe (BWB, Sponsor and Collaboration), Stadtentwässerung Braunschweig (SE|BS, Collaboration), Abwasserverband Braunschweig (Subcontract and Collaboration) as well as Anjou Recherche (AR, Collaboration).

1.1 Activities and objectives of the project

Within the research project investigations were carried out in pilot and full scale trials. This report contains the deliverables of ISWW in this research work:

- The examination of co-digestion of ensiled grass and topinambur with regard to biogas yield and sludge properties at pilot scale.
- Investigation of the influence of thermal disintegration on the anaerobic digestion under selected conditions (disintegration of secondary sludge; ensiled grass; one and two step digestion) at pilot scale.
- Full scale co-digestion of ensiled grass in one of the digesters of Braunschweig WWTP.

During the **Thermal Hydrolysis Process (THP)**, sludge is firstly exposed to temperatures around 160°C and pressures of about 6 bar. The subsequent abrupt decompression causes the disintegration of bacteria cells contained in the sludge. The thermal hydrolysis leads to a release of

the cellular components and replaces bacterial hydrolysis, which is the limiting process step during digestion. Furthermore it is used to disintegrate components which cannot be hydrolyzed biologically during anaerobic digestion.

Co-Digestion of co-substrates during the anaerobic stabilization is an option to increase the biogas production while using idle capacities of the digester volume. The fermentation of biogenic co-substrates, such as grease from food industries, is frequently performed at WWTPs. The testing of co-digestion with green biomass and combined thermal disintegration of secondary sludge and co-substrate are further objectives of this research work.

1.2 Planning and running of the project

The project CoDiGreen is divided into different fields of activity. The Institute of Sanitary and Environmental Engineering (ISWW) is concerned with the pilot scale trials (THP and co-digestion) and the full scale trials (co-digestion of ensiled grass).

The tests in **pilot scale** were carried out in two test series, each consisting of an adaption period and an intensive monitoring program (IMP) of four weeks. In the test series different co-substrates were added (ensiled grass and topinambur) and the thermal disintegration was implemented as a pre-treatment as well as integrated between two digestion steps. The pilot scale trials were carried out from 15th July 2010 until 18th of March 2011. During this period there was a successive information exchange and a decision making for further steps with the CoDiGreen team members and the Technical Committee (TC) (see chapter 2 and 3 for the research program and the results of the lab-scale trials).

The **full-scale** trials have mainly been performed in parallel to the lab-scale ones. After the kick-off meeting in March 2010, the WWTP of Braunschweig has been prepared for the trials. The equipment needed – mainly the feeding- and mixing unit to mix the co-substrate in the sludge – has been bought; additionally, the digester towers have been equipped with an additional gas measurement. The first harvest of the grass was at the end of June 2010; the second one in September 2010. The addition of the ensiled grass – and thus, the duration of the full-scale trials – started in November 2010 and lasted until August 2011. As for the lab-scale trials, one **IMP** of six weeks was performed in 2011 from June, 13 to July, 31. The program and the results of the full-scale trials are given in chapter 4 and 5. A conclusion of both project parts is given in chapter 6.

Planning and running of the project required a lot of engagement and effort of the involved staff. The feeding of the full scale digester at KWS with co-substrate was carried out daily during the complete duration of the project, causing additional workload. The service of the four pilot scale reactors included manual preparation and daily feeding with the particular substrates. The features of the pilot scale reactors were adapted to the needs of the project and a new gas measurement

system was developed by ISWW. The mechanical engineering and the electric installations for the full scale trials were integrated in the existing operational facilities by SEIBS in own effort, as well as the additional analytical program required for the project.

2 Research program of lab-scale trials

2.1 Preliminary tests

The research program is based on preliminary batch tests, which were carried out at ISWW in order to investigate the influence of co-digestion and thermal hydrolysis on the specific biogas yield. The investigated co-substrates were grass (ensiled), topinambur tubers, topinambur plants, maize (ensiled), garden waste and waste from the maintenance of rivers. The conditions of the thermal disintegration varied from 120°C to 140°C and 160°C with corresponding pressures. The temperature of digestion was mesophilic or thermophilic.

The results for the specific gas production of the preliminary batch tests are shown in Figure 2-1.

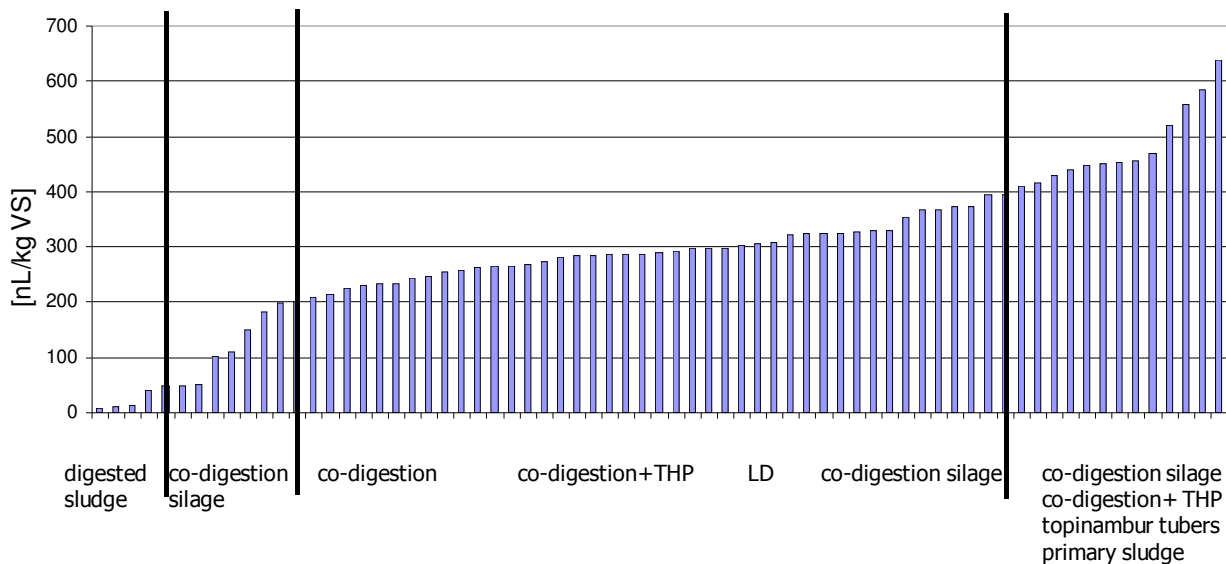

Figure 2-1: Results of the preliminary anaerobic batch tests. Specific gas yield of batch tests with variations of co-digestion and THP.

Four ranges are distinguished regarding the increasing specific gas production of the batch tests. The first range shows the results of the reference batch tests with digested sludge, which was used as seeding sludge in all batch tests, without any substrates in mesophilic and thermophilic digestion. The second range shows batch tests that produced less than 200 NL/kg VS_{added}. These were mainly batch tests with mono digestion of substrates, e.g. ensiled grass (48) and maize (50) or garden waste (41). The pre-treatment with THP increased the specific gas production of the mono-digestion significantly for ensiled grass (284) and ensiled maize (329), whereas the specific gas production of garden waste (110) was influenced marginally by THP. Most of the batch tests produced between 200 and 400 NL/kg VS_{added}, e.g. batches with raw sludge, co-digestion of garden waste, topinambur. Within this range the specific gas production mostly increased after THP. More than 400 NL/kg VS_{added} were produced by batch tests with raw sludge after THP, a combination of THP and co-digestion and thermophilic digestion.

Based upon the results of the preliminary tests, ensiled grass and ensiled topinambur were favoured co-substrates for the continuous pilot trials. The addition of co-substrates was assessed to 10% related to the TS. Mesophilic digestion was assessed for all pilot scale trials. The conditions of the thermal hydrolysis process were determined as 160°C and 6 bar pressure for 30 minutes.

2.2 Description of the pilot plant

The anaerobic digestion has been carried out in parallel with four lab-scale digesters with a gross volume of 40 litres each (see Figure 2-2) in a container with mesophilic conditions. A motorized drive system circulated the sludge in the reactors. Depending on the chosen hydraulic retention time, the reactors were filled up to 24 to 30 litres. Each reactor was equipped with two outlets, one in the middle of the height for discharging sludge and another one at the bottom as a scour. The feeding was performed with a fitting adaptor at the inlet (see Figure 2-3).

The thermal disintegration of sludge was realized in a lab-scale thermal hydrolysis plant (THP, see Figure 2-4) at a temperature of 160°C with corresponding pressures for 30 minutes.



Figure 2-2: Anaerobic reactors in lab scale.

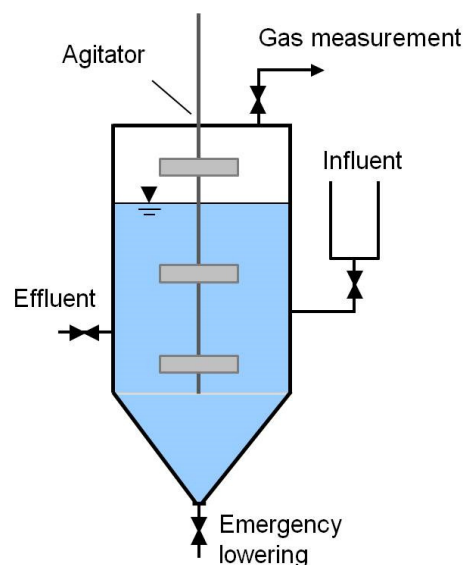

Figure 2-3: Basic diagram of the lab-scale reactor.

The semi technical THP-Plant was made by Stulz Wasser- und Prozesstechnik, Grafenhausen, Germany in 2007. The plant consists of four main parts:

- Steam generator
- Hydrolysis reactor
- Decompression tank
- Control unit (see Figure 2-5).

The steam generator and the hydrolysis tank possess a heating tape. In the hydrolysis tank the sludge was pre-heated to 120°C by the heating tape. Subsequent hot steam was added to the heated sludge until the conditions for thermal hydrolysis were realized.



Figure 2-4: THP-plant in laboratory scale.



Figure 2-5: Control unit of the THP.

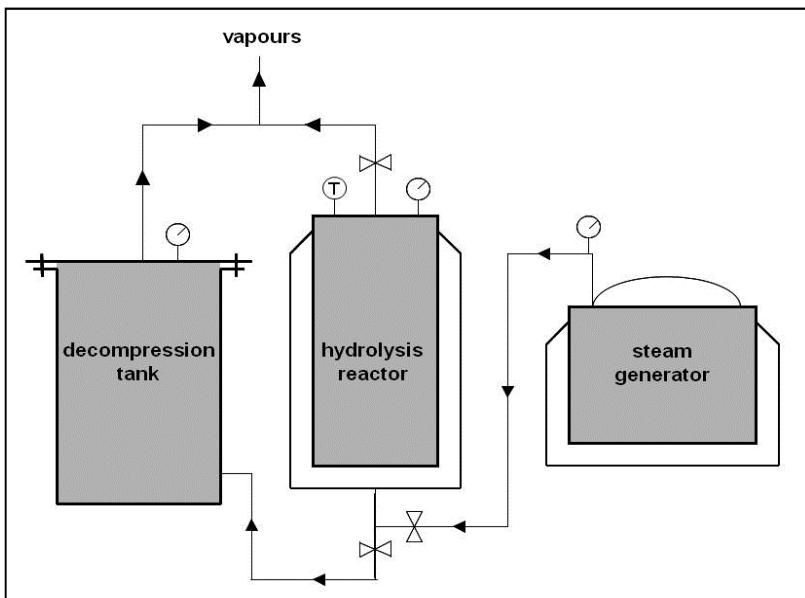

Figure 2-6: Basic diagram of the THP in laboratory scale.

To quantify the gas production of each digester an electronically driven measurement system was developed for the lab-scale trials. The system for each reactor consists of a gas cylinder ($V = 1.5$ litres) which is regulated by a three-way solenoid valve. The production of gas in the reactor increases the pressure in the system. After the pressure has reached 50 mbar, the magnetic valve closes the connection to the reactor and opens the pipe to the gas outlet. Each outlet procedure was counted by a measuring and control unit. Immediately after the pressure in the cylinder has reached the atmospheric pressure, the magnetic valve turns back to open the connection to the reactor again, to repeat the procedure. The measuring and control unit also records the air-pressure and the temperature.



Figure 2-7: Measuring system for the gas yield detection.



Figure 2-8: Measuring and control unit.

2.3 Program of the experimental series

The first ten weeks (15.07.2010 until 22.09.2010) of the digestion tests were used for the adaption of the anaerobic biocenosis to the hydrolysed sludge and the co-substrates for a period of at least three sludge ages. The first intensive monitoring period (IMP-I) lasted 39 days. Table 2-1 lists the measured parameters in an IMP. After the first IMP the reactors were modified for the second series (23.11.2010 to 24.11.2010). The adaption time of the anaerobic biocenosis (25.11.2010 until 02.02.2011) starts again to prepare the second IMP-II, which lasted 32 days.

Table 2-1: Overview on the analysed parameters during the IMP.

parameter of analyses		frequency of analyses		
		influent	effluent	biogas
standard analyses	Total Solids (TS)	twice per week	twice per week	--
	Total Volatile Solids (TVS)			
	Chemical Oxygen Demand (COD)			
	Dissolved Chemical Oxygen Demand (COD _s)			
	Total Kjeldahl Nitrogen (TKN)			
	Ammonium-Nitrogen (NH ₄ -N)			
	Total Phosphorus (P _{tot})			
	Phosphate-Phosphorus (PO ₄ -P)			
	Organic Acids	--	twice per week	--
	Quantities of Biogas	--	--	continuously
Quality of Biogas	--	--	once per week	
special analyses	Refractory COD (Zahn-Wellens-Test)	--	once per IMP	--
	Thermo Gravimetric Measurement (TGM)	--	1x4 per IMP	--
	Microbiological Parameters	--	once in IMP-I	--
	Organic Pollutants	--	once per IMP	--
	Heavy Metals	--	twice per IMP	--

The anaerobic degradation tests were carried out with primary sludge and excess sludge in four lab-scale reactors. The raw sludge consisted of a mixture of 50% primary sludge and 50% excess sludge related to total solids. The addition of co-substrates was 10% related to the total solids. In Table 2-2 an overview on the two test series and the mix of sludge is shown. In both test series R1 was the reference reactor and R3 was the reactor for the co-digestion. The THP was integrated in IMP-I in a LD-configuration (Lysis-Digestion) in R2 and a combined thermal disintegration of excess sludge and ensiled grass before the digestion in R4.

In the second test series the co-digestion was carried out with ensiled topinambur in reactor R3. The THP was implemented in a DLD-configuration (Digestion-Lysis-Digestion) within two reactors connected in series (see Figure 2-11). The hydraulic retention time of the raw sludge in reactor R2 (DLD-I) was 12 days. The effluent of the DLD-I reactor (R2) was treated with the THP and after thermal disintegration fed to reactor R4 (DLD-II) with a hydraulic retention time of 9 days, so that the total HRT of the DLD-configuration of 21 days was the same as in the reference reactor R1.

Table 2-2: Overview on the Experimental Series IMP- I and IMP-II.

	reactor	HRT [d]	mix of sludge	TS-ratio of the mix		
				Raw sludge		co-substrate
				primary sludge	excess sludge	
experimental series I	R1	20	PS + ES	50 %	50 %	--
	R2 (LD)		PS + ES _{160°C}	50 %	50 %	--
	R3		PS + ES + Grass (ensiled)	50 %	50 %	+10 %
	R4		PS + (ES + Grass) _{160°C}	50 %	50 %	+10 %
experimental series II	R1	21	PS + ES	50 %	50 %	--
	R2 (DLD-I)	12	PS + ES	50 %	50 %	--
	R3	21	PS + ES + Topinambur (ensiled)	50 %	50 %	+10 %
	R4 (DLD-II)	9	Effluent of DLD I _{160°C} (R2)	50 %	50 %	--

PS = primary sludge; ES = excess sludge; 160°C = treatment with THP

The following two figures (Figure 2-9 and Figure 2-10) show the two ensiled co-substrates from the irrigation fields which were used during the research program. The harvested grass and topinambur were ensiled in a silage tube at the wwtp. The ensiled grass (Figure 2-9) had a cutting length between 5 mm and 30 mm and had to be shredded to a size of 5 - 8 mm before it could be used in the pilot scale trials. The topinambur (ensiled, Figure 2-10) was shredded for pilot scale trials as well.



Figure 2-9: Ensiled grass harvested in the irrigation fields.

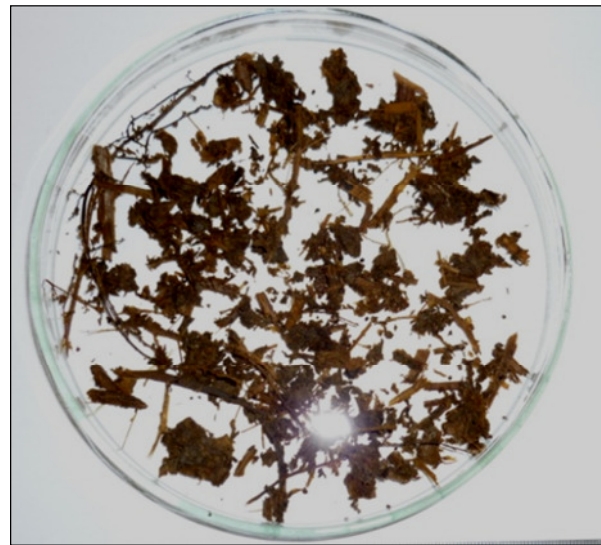

Figure 2-10: Topinambur (ensiled) harvested in the irrigation fields.

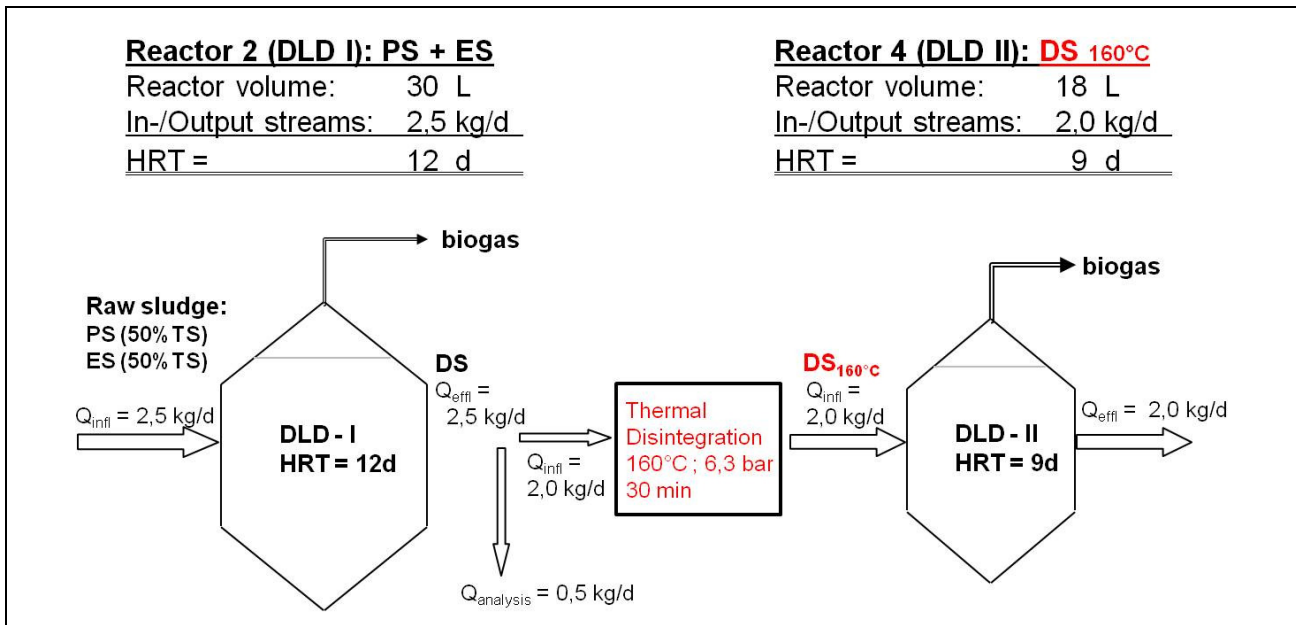

Figure 2-11: Basic diagram of the DLD-configuration.

2.4 Evaluation of the data from pilot scale reactors

The evaluation of data from the pilot scale reactors is based upon mass balances of input and output streams of a reactor during an intensive monitoring programme (IMP). The loads in a stream were calculated by parameters that were measured twice a week.

Mass balances of the parameters chemical oxygen demand (COD) and carbon (C) were established in order to control the plausibility of the measured biogas yield of the reactors. The parameters phosphorous (P_{total}) and Total Kjeldahl Nitrogen (TKN) were balanced in order to control the plausibility of influent and effluent of the reactors. A mass balance compares the cumulative loads of a parameter in output and input streams of a reactor during an IMP. The input of a reactor includes the influent stream and the content of a parameter in a reactor at the beginning, taking into account the content at the end of an IMP. The calculation of the output includes the effluent of a reactor and the load in the produced biogas. For example the mass balance of COD can be calculated by following relation:

$$COD_{input} = COD_{reactor,start} + COD_{influent} - COD_{reactor,end}$$

$$COD_{output} = COD_{methane} + COD_{effluent}$$

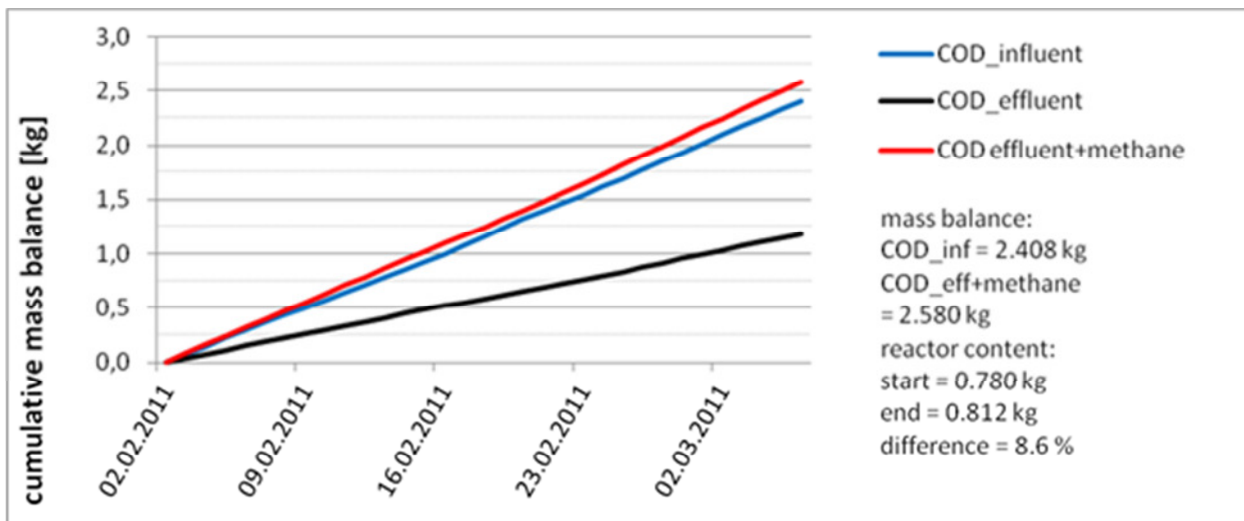

Figure 2-12 shows exemplarily the COD-mass balance of reactor R1 during the second intensive monitoring programme and illustrates the calculation of output minus input. The COD of methane in the biogas is calculated by the conversion factor of 3.989 gCOD/gCH₄. Including the reactor content, the difference summarizes up to 8.6% in regard to the input. As illustrated in Table 3-2 exemplarily most of the mass balances differ less than 10%, which confirms the plausibility of the results presented.

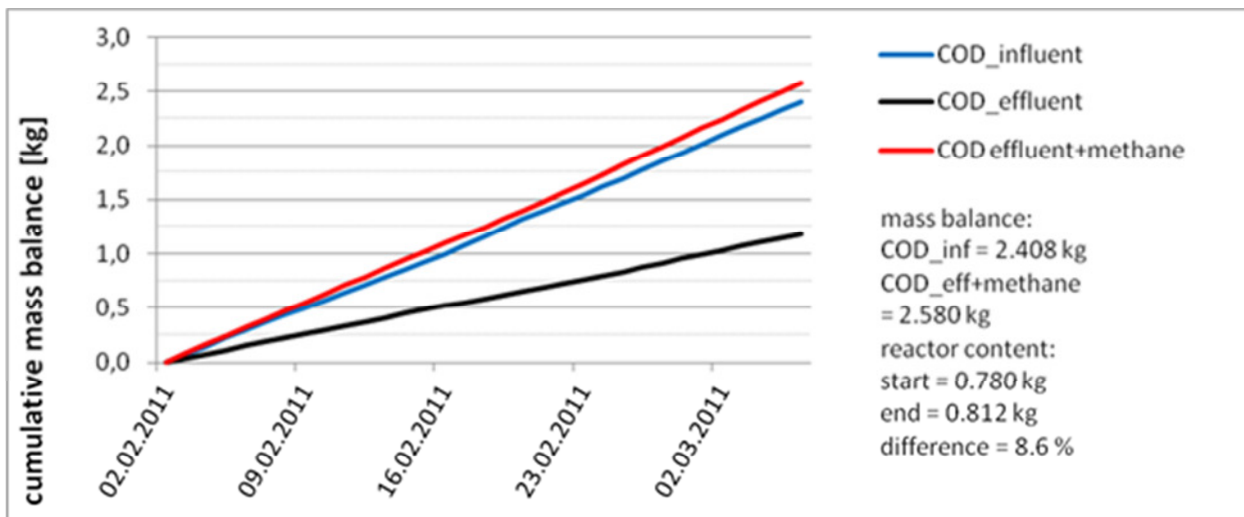

Figure 2-12: COD-Mass Balance of reactor R1 in IMP-II.

The biogas yield of the reactors is related to the added load of volatile solids in order to calculate the specific biogas yield [NL/kg VS]. In order to quantify the increase of the specific gas yield in case of co-digestion, the biogas yield is related to the total amount of added volatile solids (VS_{added}) as well as to the added volatile solids of the sludge (VS_{sludge}).

Figure 2-13 shows the specific gas yield of reactor 1. The plotted curves describe the daily and the cumulative specific gas yield. Also shown is the specific gas yield that has been calculated over the

period of the hydraulic retention time of 21d.

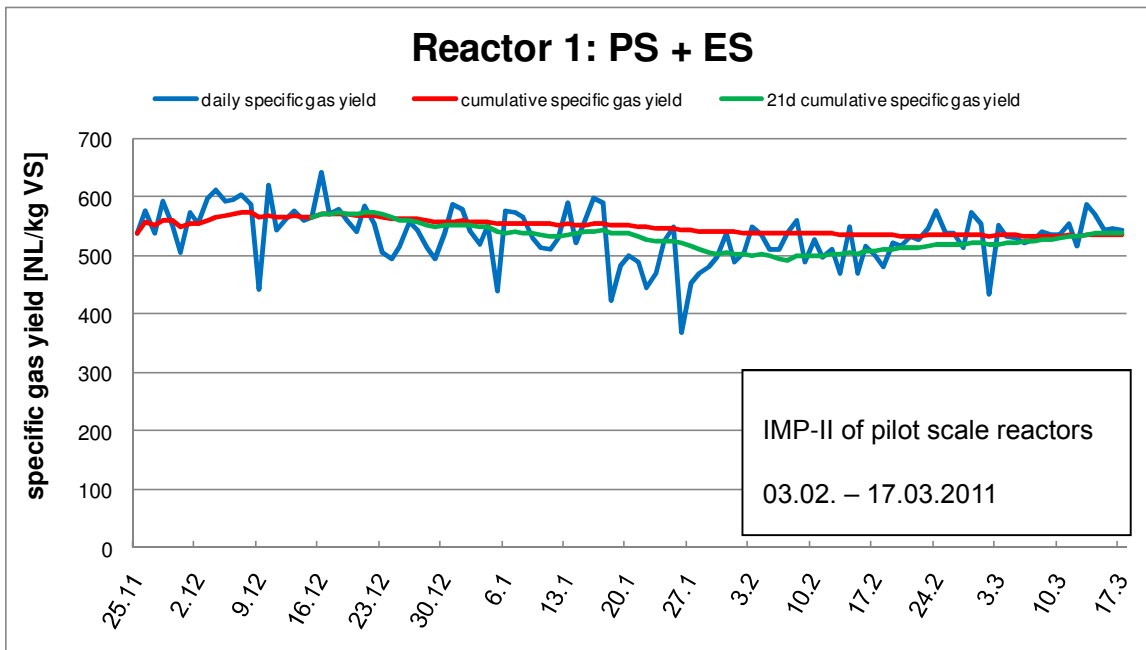

Figure 2-13: Performance of the specific gas production of the reference reactor R1.

In addition to the mass balances mentioned above, balances of total solids (TS) as well as volatile solids (VS) are established in order to determine the degradation and describe the efficiency of the sludge digestion.

Within the project CoDiGreen special analyses of organic pollutants (priority substances and pharmaceutical substances) and heavy metals were carried out in order to determine the impact of thermal disintegration and co-digestion on the contaminant loads of the sludge. The monitored organic micropollutants were selected in accordance with the limiting values of the amended sewage sludge ordinance and priority substances of the water framework directive. The measurements of organic pollutants in the digested sludge were carried out at the LUFA (see annex 7.2). The concentration of heavy metals in influent and effluent of the reactors has been measured in the laboratory at the wastewater treatment plant KWS (see annex 7.1). The dried sludge samples as well as filtered ($< 0,45 \mu\text{m}$) samples were analysed. The monitored pharmaceuticals, as relevant compounds in sludge according to previous studies, were analysed by the laboratory of Veolia (see analytical protocol in annex 7.3). The measured parameters and the results are listed in chapter 3.3.

The analysis of the filtered samples of the digested sludge characterizes the return loads to the wastewater treatment plant, taking into account the parameters COD_s , $\text{NH}_4\text{-N}$ and $\text{PO}_4\text{-P}$. The aerobic biodegradability of COD_s after dewatering has been characterized in a modified Zahn-Wellens Test over 72 h [Wittenberg, M.; 2003].

Tests with the thermo-gravimetric method determine the water fractions in a sludge and characterize the dewaterability of the digested sludge [Kopp, J.; 2001]. These tests were carried out, in order to determine the impact of thermal hydrolysis and co-digestion on dewaterability of digested sludge.

3 Results of lab-scale trials

3.1 Mass balances

The mass balances were established by comparing input and output loads of the analyzed parameters in the streams of input and output of the reactors as described in chapter 2.4.

The COD mass balances during the intensive monitoring programmes are listed in Table 3-1.

Table 3-1: COD mass balances of the pilot scale reactors.

reactor	HRT	$Q_{inf} = Q_{eff}$	COD _{reactor,start}	COD _{influent}	COD _{reactor,end}	COD _{methane}	COD _{effluent}	difference	
								$(\sum COD_{out} - \sum COD_{in})$	
	[d]	[kg/d]	[kg]	[kg]	[kg]	[kg]	[kg]	[kg]	[%]
IMP-I 39d (23.09. - 31.10.2010)									
R1: PS+ES	20	1.2	0.699	2.917	0.684	1.755	1.376	0.199	6.8%
R2: PS+ES _{160°C}	20	1.2	0.610	2.821	0.556	1.789	1.154	0.068	2.4%
R3: PS+ES+GS	20	1.2	0.875	3.111	0.743	2.101	1.525	0.382	11.8%
R4: PS+(ES+GS) _{160°C}	20	1.2	0.737	3.040	0.647	1.984	1.349	0.202	6.5%
IMP-II 32d (3.2. - 6.3.2011)									
R1: PS+ES	21	1.2	0.780	2.408	0.812	1.393	1.187	0.204	8.6%
R3: PS+ES+Topi	21	1.2	0.868	2.577	0.846	1.563	1.305	0.269	10.3%
R2: PS+ES (DLD- I)	12	2.5	1.024	5.017	1.015	2.686	2.655	0.314	6.3%
R4: DS _{160°C} (DLD- II)	9	2.0	0.236	1.683	0.355	0.529	1.108	0.074	4.7%

Usually COD analysis of sludge has deviations of approximately 10 to 15% due to the small sample volumes and the high influence of particulate matter of the sludge samples. Especially the samples with co-substrate were homogenized intensively. With a maximum difference of altogether 11.8% during the balanced periods, the deficit is relatively low for COD balances. Apart from the samples with co-substrate without THP the difference of the COD balances was in all cases lower than 10%.

The results of all established mass balances concerning the parameters COD, TC, TKN and P are listed in Table 3-2. The results of the TC mass balances confirmed the COD balances. So, that the measured biogas yield was confirmed by the mass balances of the reactors including the biogas. The mass balances of TKN and phosphorus described the influent and effluent streams and confirmed the plausibility of the measurements as well.

Table 3-2: Survey of differences in the mass balances over the Intensive monitoring program.

IMP- I	COD	TC	TKN	P
R1: PS+ES	6.8%	11.4%	3.9%	-6.6%
R2: PS+ES _{160°C} (LD)	2.4%	9.9%	-1.9%	-6.5%
R3: PS+ES+GS	11.8%	13.8%	2.2%	-4.9%
R4: PS+(ES+GS) _{160°C}	6.5%	3.2%	-5.6%	-3.0%
IMP- II	COD	TC	TKN	P
R1: PS+ES	8.6%	12.6%	-3.2%	-9.4%
R3: PS+ES+Topi	10.3%	6.9%	-1.6%	-5.4%
R2: PS+ES (DLD- I)	6.3%	10.4%	-1.4%	-3.9%
R4: DS _{160°C} (DLD- II)	4.7%	5.2%	3.7%	1.0%

The results of the mass balances of volatile and total solids are listed in Table 3-3. Shown are the volumetric loading, the degradation of volatile solids and the reduction of total solids of the pilot scale reactors. The addition of co-substrate increased the volumetric loading, whereas the addition of steam in the thermal hydrolysis process decreased the volumetric loading due to a dilution of the sludge. The first reactor in the DLD-configuration (R2) with a reduced hydraulic retention time of 12 days had a mean volumetric loading of 3.8 gVS/L*d. The calculated volumetric loading of the entire DLD-configuration corresponded to the volumetric loading of the reference reactor R1 of 2.19 gVS/L*d. This calculation took the removal of sludge for analysis into account. The thermal hydrolysis increased the degradation of volatile solids and the reduction of total solids in the LD-configuration. The most significant increase of more than 20 percentage points resulted from thermal hydrolysis in the DLD-configuration regarding both, the degradation of volatile solids and the reduction of total solids.

Table 3-3: Results of the mass balances of volatile and total solids.

reactors	HRT	$Q_{inf} = Q_{eff}$	volumetric loading	VS-degradation	TS-reduction
IMP- I 39d (23.09. - 31.10.2010)	[d]	[kg/d]	[g VS/L*d]	[%]	[%]
R1: PS+ES	20	1.2	2.18	53%	44%
R2: PS+ES _{160°C} (LD)	20	1.2	2.10	60%	51%
R3: PS+ES+GS	20	1.2	2.38	54%	45%
R4: PS+(ES+GS) _{160°C}	20	1.2	2.23	60%	48%
IMP-II 32d (3.2. - 6.3.2011)	[d]	[kg/d]	[g VS/L*d]	[%]	[%]
R1: PS+ES	21	1.2	2.19	54%	46%
R3: PS+ES+Topi	21	1.2	2.28	51%	43%
R2: PS+ES (DLD- I)	12	2.5	3.82	49%	41%
R4: DS _{160°C} (DLD- II)	9	2.0	2.32	53%	43%
DLD	21	-	2.19	76%	66%

3.2 Kinetics and performance of the biogas production

Kinetics of biogas production

During the anaerobic digestion in lab-scale trials a periodic change of the biogas production within each feeding period could be observed. Figure 3-1 exemplarily shows the cumulative biogas yield of the four reactors in IMP-I over a period of two feeding steps, which are indicated by the red arrows.

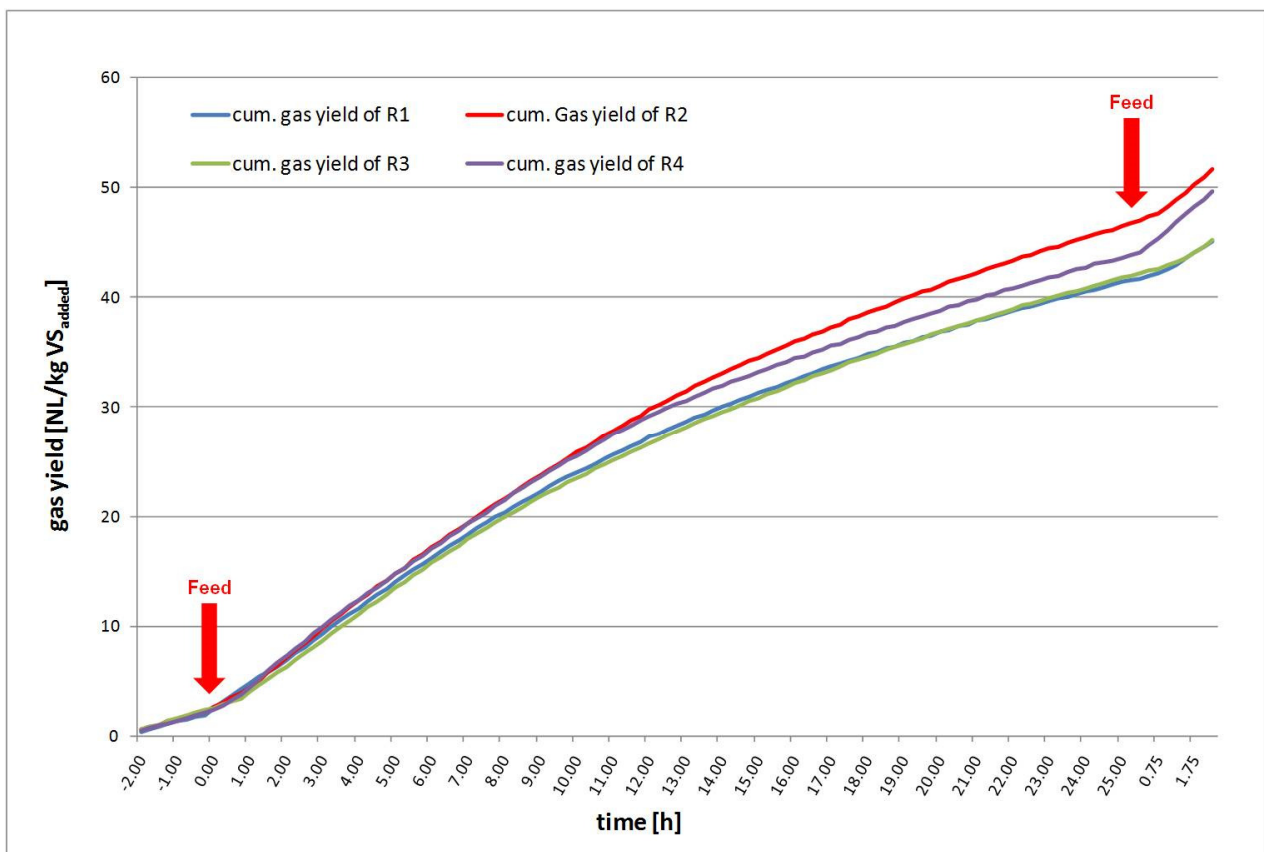

Figure 3-1: Biogas kinetics of the cumulative specific biogas yield of the reactors in IMP-I.

The performance of all reactors was quite similar in principle. Due to the detailed recording of the biogas yield, it could be noticed that the rates of biogas production increased shortly after the beginning of the feeding. After a few hours the rate decreased until the endogenous metabolic rate is reached.

In Figure 3-1, the endogenous metabolic rate of the digested sludge approximately 24 hours after the last feeding is displayed by the curves from -2.00 until hour 0.00 (feeding). After feeding, the biogas production rates increased rapidly, but finally reaching the endogenous metabolic rate again. The influence of the THP in R2 and R4 could be observed in a significant increasing of the biogas production rates. Moreover, the endogenous metabolic rate is reached later than in the reference due to the higher amounts of substrate available for digestion.

Although the co-digestion of ensiled grass in R3 (without THP) led to similar gas production rates as in the reference R1, the biogas production rate of R1 compared to R3 was slightly higher at the beginning and slightly lower at the end of the feeding cycle.

An impact of the observed biogas production dynamics during the full scale operation of the digester is supposed to be not comparable since the full scale digester are fed much more continuously compared to the lab scale ones. Thus the biogas production is expected to be more constant and the dynamics significant lower.

Performance of biogas production

Figure 3-2 shows the production of biogas of the two reactors of the DLD-configuration during the intensive monitoring period. The plotted curves show the specific gas production and the acetic acid equivalent of the DLD-reactors.

Although the hydraulic retention time of the first DLD-reactor was reduced to 12 days and the volumetric loading was relatively high at 3.8 gVS/L*d a stable production of biogas was detected. Thus the measured acetic acid equivalent of the DLD-I did not exceed 50 mg/L and the pH-value of the effluent was 7.2.

In the DLD-configuration the effluent of DLD-I after thermal hydrolysis (pH \approx 9) became the influent of the DLD-II reactor (R4). The hydraulic retention time in the DLD-II reactor was 9 days. The reactor kept on producing biogas, although a temporarily high concentration of organic acids was detected for 7 days. The maximum acetic acid equivalent was measured at 1881 mgAE/L but the pH-value did not fall below 7.1. Thus the specific biogas production of the DLD-II reactor increased during the intensive monitoring programme due to a further adaption of the bacteria. All other reactors showed also very stable conditions over the trials period.

Reactor 2 (DLD-I): PS+ES HRT=12d

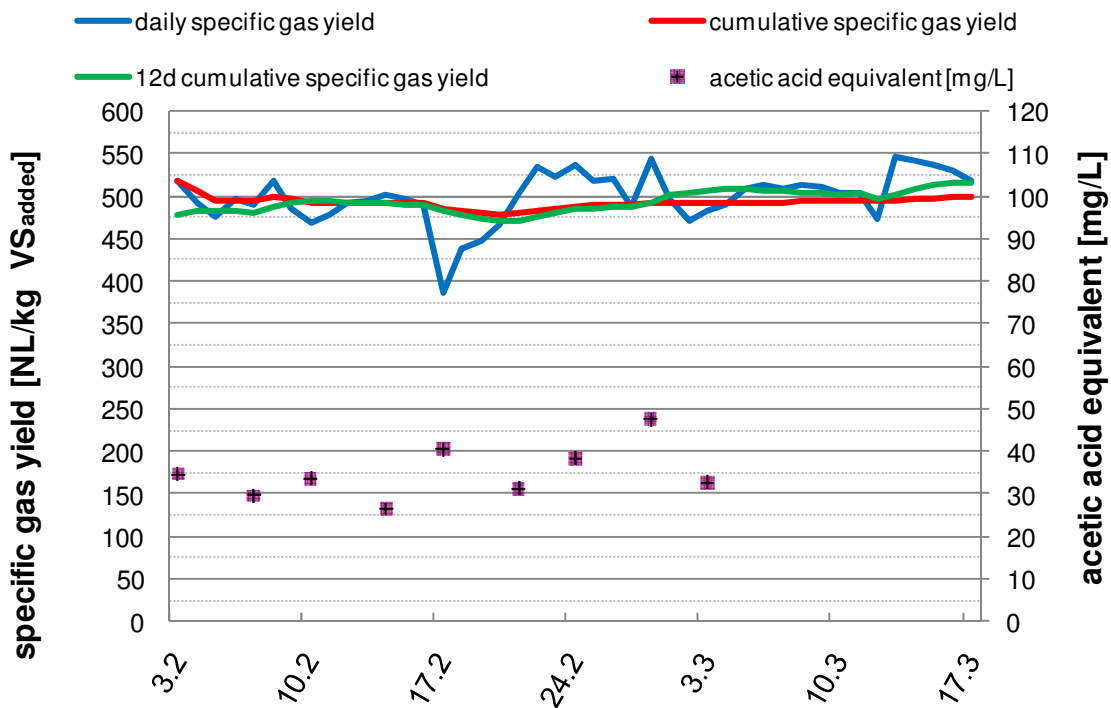

Reactor 4 (DLD-II): DS 160°C HRT=9d

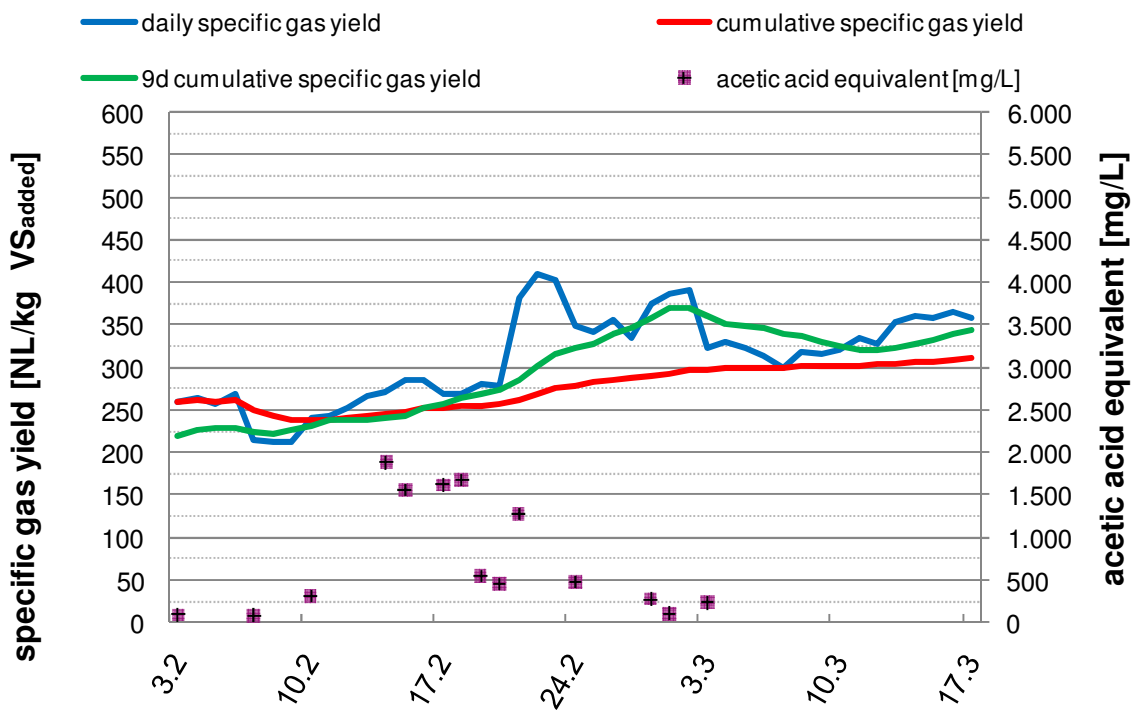

Figure 3-2: Performance of the specific biogas yield of the DLD-configuration.

Table 3-4 lists the performance of the biogas production of the pilot scale reactors during the first intensive measuring programme. The calculation of the specific gas production has been extended up to 60 days until the modification of the reactors for IMP-II started.

The influence of the co-digestion of ensiled grass resulted in an increase in the methane content of biogas. In both cases, without thermal hydrolysis and with thermal hydrolysis in the LD-configuration the influence of ensiled grass was an increase of 4.3 percentage points. Whereas thermal hydrolysis (with and without co-digestion) resulted in an increase of 0.9 percentage points of the methane content in the biogas.

The co-digestion of ensiled grass increased the specific gas yield by 23% (without THP) and 27% (with THP) if the gas production is only related to the TS-content of the sludge. The specific gas yield of the co-digestion of ensiled grass related to the total amount of added VS was increased by 2% (without THP) and 5% (with THP), if compared to the reference reactor R1. The thermal disintegration of the sludge increased the specific gas yield in the LD-configuration by 8%. If ensiled grass is co-digested (R3 and R4), the THP increased the specific gas yield by 2.7% (related to VS_{added}) and by 3.4% (related to VS_{sludge}).

Table 3-4: Overview on the specific gas yield and the increase by co-digestion and TDH in IMP-I.

IMP- I 23.09. - 22.11.2010	HRT	$Q_{inf} = Q_{eff}$	methane content	specific gas yield [NL/kg VS]			increase by Co-Digestion		increase by TDH	
				VS added	VS sludge	VS removed	[%]*	[%]**	[%]*	[%]**
reactor	[d]	[kg/d]	[%]							
R1: PS+ES	20	1.2	63.6	575		1062	-	-	-	
R2: PS+ES _{160°C}	20	1.2	64.5	623		1018	-	-	8	
R3: PS+ES+GS	20	1.2	67.9	586	707	1073	2	23	-	-
R4: PS+(ES+GS) _{160°C}	20	1.2	68.8	602	731	1019	5	27	3	3

* related to total VS added ** related to VS in the sludge

The performance of the biogas production in the DLD-configuration and the co-digestion of ensiled Topinambur are shown in Table 3-5. The impact of thermal hydrolysis in the DLD-configuration was an increase in the methane content by 0.5 percentage points, whereas the co-digestion of ensiled topinambur increased the methane content by 1.3 percentage points.

The reduction of the hydraulic retention time to 12 days in the DLD-I reactor caused a decrease in the specific gas yield of -5.7%. That showed that in a fully adapted reactor 94.3% of the biogas compared to the reference (20 d) was produced within 12 days. The impact of the DLD treatment scheme on the specific gas yield was an increase of 18%, compared to the reference reactor. The specific gas yield of the reactor with the co-digestion of ensiled Topinambur was 2.4% (related to VS_{added}) and 20% (related to VS_{sludge}) higher than the specific gas yield of the reference.

3.3 Organic micro pollutants and return loads

3.3.1 Organic micro pollutants

The contaminant loads of the samples from digested sludges during the intensive monitoring programmes are listed in Table 3-7. Shown are the detected results of sum parameters for adsorbable organic halogen compounds (AOX), Nonylphenol a-c (NP), perfluorinated surfactants (PFT) and polycyclic aromatic hydrocarbons (PAH₍₁₆₎). Also shown are the measured concentrations of DEHP as a leading parameter for phthalates and Benz-a-pyrene (B_(a)P) as the leading parameter for PAH with a limit value in the amended sewage sludge ordinance.

Table 3-7: Analysis of organic micro pollutants (recovery rate typically > 75%, info LUVA).

analysis of trace organics	TS	AOX	NP	PFT	DEHP	PAH ₍₁₆₎	B _(a) P
IMP- I	[%]	[mg/kgTS]	[mg/kgTS]	[mg/kgTS]	[mg/kgTS]	[mg/kgTS]	[mg/kgTS]
R1: PS+ES	2.84	146	1.8	0.024	24.7	3.08	0.17
R2: PS+ES_{160°C}	2.61	140	2.7	0.036	38.3	7.35	0.18
R3: PS+ES+GS	3.32	144	1.5	0.026	29.7	2.63	0.16
R4: PS+(ES+GS)_{160°C}	3.46	116	2.1	0.032	39.1	7.82	0.15
IMP- II	[%]	[mg/kgTS]	[mg/kgTS]	[mg/kgTS]	[mg/kgTS]	[mg/kgTS]	[mg/kgTS]
R1: PS+ ES HRT=21d	2.77	128	1.8	0.014	29.7	1.69	0.10
R3: PS+ES+Topi HRT=21d	2.85	125	1.8	0.017	17.1	1.52	0.11
R2: PS+ES HRT=12d (DLD-I)	2.98	232	1.6	0.012	31.7	1.53	0.10
R4: DS_{160°C} HRT=9d (DLD-II)	1.32	252	3.5	0.028	36.6	1.89	0.14
limit of quantification (LOQ)		50	0.5	0.01	10	0.05	0.05
limit value sewage sludge ordinance 1992		500	-	-	-	-	-
amended sewage sludge ordinance 2012		400	-	0.1	-	-	1
* for each PAH							

The measured concentrations of the analyzed parameters were clearly below the limit value of the sewage sludge ordinance; there was no exceedance of any limit value. Nevertheless some key trends for the analyzed parameters will be shown in the following as far as they could be observed.

The highest AOX concentrations were measured for the DLD-configuration which might be related to the lower hydraulic retention times in the reactors. The concentrations of NP, PFT, DEHP and PAH₍₁₆₎ were in both IMP (PAH₍₁₆₎ only in IMP-I) significantly increased in the reactors fed with substrates after thermal hydrolysis. Although the concentrations of all analyzed organic micropollutants were higher in DLD-II compared to the reference their overall load was lower due to high solids degradation in DLD-II. The concentration of B_(a)P, standing for the group of PAH in the sewage sludge ordinance, ranged in both IMPs from 0.10 to 0.18 mg/kg TS and was influenced only marginally by the thermal hydrolysis. The concentration of PFT summarizes the concentrations of PFOA and PFOS (not shown here). The measured concentrations of PFOS changed relatively marginally in all reactors and the concentration of PFOA without THP was below the limit of quantification. Therefore measured concentrations after THP were just above the limit of quantification.

The analyses at the LUFA were carried out with a preliminary addition of internal standards (in part with isotope tracing) before preparation of the samples in order to calculate the concentration of the parameters. The results of the spiking test with digested sludge are listed in Table 3-8. Shown are the concentrations of Nonylphenol, DEHP and total PAH of the reference and the spiked sludge. Also shown is the difference of concentrations, the spiking load and the recovery rate of the spiked substances. The parameter total PAH includes the concentrations of PAH₍₁₆₎ that were measured above the limit of quantification in both (reference and spiked) samples.

Table 3-8: Concentrations of NP, DEHP and total PAH in digested sludge within the spiking test.

spiking test	Nonylphenol [mg/kg TS]	DEHP [mg/kg TS]	total PAH * [mg/kg TS]
DS reference	1.7	37.2	1.5
DS spiked	2.3	35.5	3.2
delta	0.6	-1.7	1.7
spike	1.3	22.1	2.4 **
deviation rate	45%	-8%	72%

* addition of PAH above the limit of quantification of 0,05 mg/kg TS in both samples

** addition of 10 out of 16 spiking loads

Figure 3-3 shows the profile of concentrations of 10 out of 16 analysed PAH, that were detected above the limit of quantification in the reference and the spiked sludge. Also shown is the expected value, calculated by the addition of the concentrations in the reference sludge and the concentrations resulting from the spiking load of each PAH. The recovery rates of the 16 PAH within the spiking test ranged from 47% (Fluoranthren) to 89% (Benz(ghi)perlen). Benz(a)pyren as the leading parameter in the sewage sludge ordinance for the group of PAH had a recovery rate of 77%.

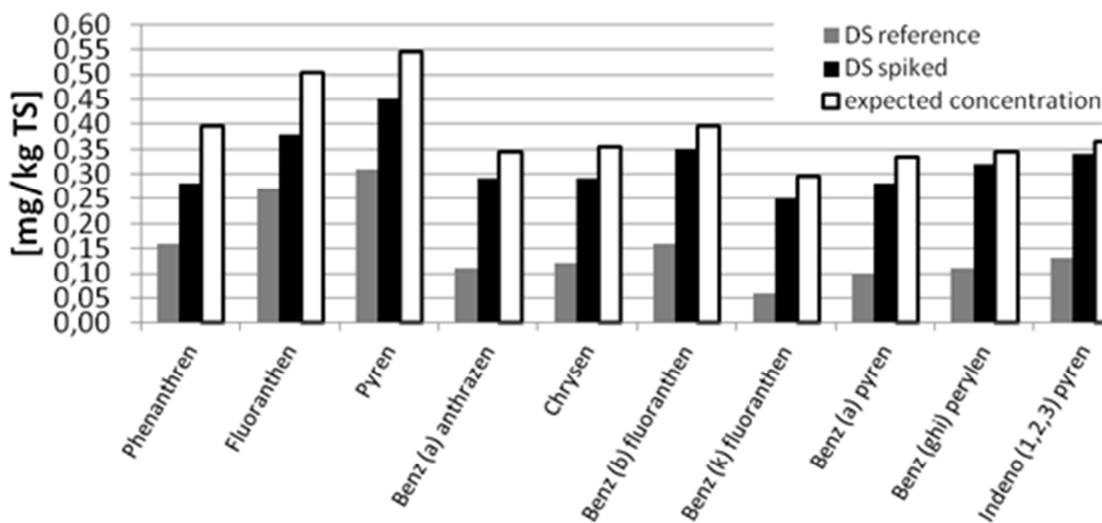

Figure 3-3: Measured concentrations of PAH in the spiking test with concentrations above the limit of quantification in both samples and the expected concentrations.

Table 3-9 lists the measured concentrations of dioxin, furan and PCB in IMP-I. The concentrations of 17 different dioxins (PCDD) and furans (PCDF) were measured and expressed as toxicity equivalent (TE). The concentration of each compound had been multiplied with its individual toxicity equivalency factor and finally summarized to calculate the toxicity equivalent. Also the concentrations of the two PCB congeners that were measured above the limit of detection are shown. All values were far below the limit value of the sewage sludge ordinance. Based upon these results the analysis of Dioxin, Furan and PCB was limited to IMP-I.

Table 3-9: Analysis of dioxin, furan and PCB in IMP-I (recovery rate typically > 75%, info LUVA).

analysis of trace organics	PCDD/ PCDF	PCB 138	PCB 153
IMP- I	[ngTE/kgTS]	[ng/kgTS]	[ng/kgTS]
R1: PS+ES	6.5	0.02	0.02
R2: PS+ES _{160°C}	7.2	0.01	0.02
R3: PS+ES+GS	5.7	0.01	0.01
R4: PS+(ES+GS) _{160°C}	6	0.01	0.02
limit of quantification (LOQ)	0.5 - 10*	0.01	0.01
sewage sludge ordinance 1992	100	0.2	0.2
amended sewage sludge ordinance 2012	30	0.1	0.1

* depending on the congener

3.3.2 Pharmaceutical substances

Five sludge samples were taken during IMP-II from the raw sludge (PS + ES), R1 outlet (reference, 21d HRT), R2 outlet (DLD1, 12d HRT), R3 outlet (+10TS Topinambur, 21d HRT) and R4 outlet (DLD2 = DLD1 + lysis + 9d HRT)

On each sample, the following 15 pharmaceutical compounds were analysed by VERI:

- Analgesic /Anti-inflammatory: Paracetamol, Diclofenac, Phenazone
- Antidepressant: Fluoxetine
- Anticonvulsant: Carbamazepine, Primidone
- Antilipidemic: Bezafibrate, Gemfibrozil
- Betablockers: Metoprolol, Propranolol
- Antibiotics: Sulfonamides, Sulfamerazine, Sulfamethoxazole, Sulfachloropyridazine
- Diaminopyrimidine: Trimethoprim

The complete set of result is presented in Annex 7.4.

Among the 15 analysed compounds, only 10/11 compounds were above quantification limits (5-10 ng/g), and only 3 compounds were detected above 100 and up to 500 ng/g.

- Diclofenac
- Carbamazepine
- Metoprolol

These compounds are known to be found in high concentrations in municipal wastewater.

The case of paracetamol is particular: it exhibits a very high value of 1,200 ng/g after a DLD process (R4 outlet), although it is usually removed by digestion in other samples. This unexpected pattern could be due to the thermal hydrolysis because this one could lead to a desorption of paracetamol, desorption that does not come with the solvents used (in the extraction protocol). A similar phenomenon was observed by VERI with liming (with mainly antibiotics) which can lead to a change in the ionic condition of the molecule leading to the breakdown of the bonds between the molecule and the particle and thus to desorption.

The variable recovery rate, due to the matrix complexity, of the pharmaceutical substances is also an issue with the current analytical techniques (26% to 228% -!- were recorded²) . Most of the detected compounds featured non satisfying recovery rates on several samples, and only one compound exhibited satisfying recovery rates (70-130%) on all analysed samples: propranolol in the range 8-27 ng/g.

Given the few numbers of samples and the uncertainty of the results due to the recovery rates, it is suggested not to draw any conclusion on the impacts of the applied operation conditions.

3.3.3 Heavy metals

An extract of the results from the analyses of heavy metals is shown in order to describe the influence of THP and Co-Digestion on the concentration of heavy metals in the digested sludge. Table 3-10 shows the concentration of heavy metals in the effluent of the reactors related to the solid fractions. Also shown is the limit value of each heavy metal which is valid for sludges with a P₂O₅ content of more than 5%. According to the sewage sludge ordinance there was no exceedance of any limit value during the investigations. The concentration of all measured heavy metals after DLD is higher than in the digested sludge of the reference reactor, due to a significantly increased degradation of volatile solids in the DLD-configuration. The comparison of the concentrations of other reactors does not show a consistent tendency.

² Positive recovery rates results sometimes from the differential calculation of the recovery rate between spiked and non spiked sample, with different analytical precision.

Table 3-10: Concentration of heavy metals in the digested sludge, limit values according to the sewage sludge ordinance 2012 and concentration of P₂O₅ in the digested sludge.

reactor	P ₂ O ₅	cadmium	chrome	copper	nickel	lead	zinc	mercury
IMP- I	[%]	[mg/kg TS]	[mg/kg TS]	[mg/kg TS]	[mg/kg TS]	[mg/kg TS]	[mg/kg TS]	[mg/kg TS]
R1: PS+ES	8.7	1.5	50.6	240	30.4	43.6	1,040	0.9
R2: PS+ES _{160°C} (LD)	10.1	1.6	48.4	257	33.5	47.1	1,065	0.8
R3: PS+ES+GS	8.8	1.5	42.8	226	28.0	41.5	974	0.6
R4: PS+(ES+GS) _{160°C} (LD)	11.0	1.6	47.7	233	37.4	43.2	1,000	0.9
IMP- II	[%]	[mg/kg TS]	[mg/kg TS]	[mg/kg TS]	[mg/kg TS]	[mg/kg TS]	[mg/kg TS]	[mg/kg TS]
R1: PS+ES	8.5	1.9	28.3	241	27.4	35.3	969	0.4
R3: PS+ES+Topi	8.6	1.8	26.1	230	22.7	33.6	916	0.4
R2: PS+ES (DLD- I)	8.4	2.2	26.7	226	23.6	33.2	947	0.4
R4: DS _{160°C} (DLD- II)	15.9	2.6	33.6	326	34.8	45.9	1,255	0.5
limit of quantification (LOQ)		0.2	0.4	0.4	0.2	1.0	0.2	0.1
limit value sewage sludge ordinance 1992		10	900	800	200	900	2,500	8
amended sewage sludge ordinance 2012		3	120	850	100	150	1,800	2

In general the THP transfers heavy metals from the solid into the dissolved phase of sludge. The impact of the THP on the concentration becomes obvious in the changing concentration of dissolved heavy metals in the two successive reactors of the DLD scheme. Table 3-11 shows the concentration of dissolved heavy metals in influent and effluent of the two reactors. Except for mercury (always below detection limit), the THP increases the concentration of dissolved heavy metals significantly, e.g. Nickel 1147%. But during digestion in the DLD-II reactor heavy metals are reincorporated in the sludge, so that the concentration of dissolved heavy metals decreases at the end. Over the entire DLD-configuration the massic concentrations of dissolved chrome, copper, nickel and zinc increased due to lower mass of total solids present in the system, whereas the concentrations of dissolved cadmium, lead and mercury are influenced relatively marginally when compared with the dilution resulting from the thermolysis.

Table 3-11: Concentrations of dissolved heavy metals in the steps of the DLD-configuration.

[µg/L]	DLD-I _{Influent}	DLD-I _{Effluent}	→ THP →	DLD-II _{Influent}	→ Digestion →	DLD-II _{Effluent}	DLD-I _{Influent} → DLD-II _{Effluent}
Cadmium	< 0.4	< 0.4	363%	1.9	-78%	< 0.4	-
Chrome	8.0	6	393%	30	-30%	21	163%
Copper	22.4	39	836%	365	-86%	50	123%
Nickel	25.2	22	1147%	276	-43%	156	519%
Lead	20.6	19	168%	52	-55%	24	17%
Zinc	114.0	203	713%	1650	-75%	405	255%
Mercury	< 0.2	< 0.2	-	< 0.2	-	< 0.2	-

3.3.4 Return loads in the sludge liquor

The concentration of the parameters COD_s, NH₄-N and PO₄-P in the sludge liquor are listed in Table 3-12. The analyses were carried out in order to characterize the return loads that are listed in Table 3-12 as the percentage in relation to the average influent loads. The calculation of the influent loads was based upon 600 m³/d of sludge liquor and 63,000 m³/d influent to WWTP Braunschweig.

Table 3-12: Return loads of COD_s, N and P after dewatering of sludge and percentage of return loads related to average influent loads of the Braunschweig WWTP.

reactors	COD _s		NH ₄ -N		PO ₄ -P	
	[mg/L]	[%]	[mg/L]	[%]	[mg/L]	[%]
IMP-I						
R1: PS+ES	617 (525 - 753)	1.0	1,089 (1,040 - 1,180)	16.7	209 (200 - 216)	22.0
R2: PS+ES_{160°C} (LD)	1,382 (1,208 - 1,530)	2.3	1,204 (890 - 1,345)	18.5	210 (185 - 260)	22.2
R3: PS+ES + GS	948 (789 - 1,342)	1.6	1,105 (1,065 - 1,190)	17.0	206 (199 - 216)	21.8
R4: PS+(ES+GS)_{160°C} (LD)	1,831 (1,674 - 1,946)	3.1	1,165 (800 - 1,335)	17.9	212 (188 - 268)	22.3
IMP-II						
R1: PS+ES	603 (481 - 684)	1.0	1,070 (1,030 - 1,140)	16.4	182 (171 - 188)	19.2
R3: PS+ES+Topi	650 (582 - 726)	1.1	1,024 (980 - 1,335)	15.7	165 (160 - 169)	17.4
R2: PS+ES (DLD-I)	529 (511 - 554)	0.9	959 (880 - 1,025)	14.7	186 (167 - 193)	19.6
R4: DS_{160°C} (DLD-II)	4,184 (3,007 - 4,900)	5.1	1,142 (1,040 - 1,270)	17.5	195 (190 - 206)	20.6

The analyses detected a significant increase in the concentration of COD_s in the effluent of the reactors with thermal hydrolysis in LD as well as DLD. The calculated return loads of COD_s ranged from 0.9% to 5.1% related to the influent loads. The percentage of the return loads of the reference reactors summarized up to 1% in both IMP and was increased by the THP treatment in all cases up to 2.3% after LD, 3.1% after LD with co-digestion and 5.1% in the DLD-configuration. Neither co-digestion nor thermal hydrolysis showed a clear tendency for the concentrations as well as the return loads of NH₄-N and PO₄-P. In contrast to COD_s the return loads among the reactors ranged from 14.7% to 18.5% for NH₄-N and for PO₄-P from 17.4% to 22.3%.

The concentration of COD_s in the effluent of the pilot scale reactors during IMP-II is shown in Figure 3-4. In the beginning of IMP-II the COD_s concentration in the effluent of the DLD-II reactor

reached approximately 5.000 mg/L and decreased continuously towards the end due to further adaption of the biomass. Finally a residual COD_s concentration of 3.007 mg/L, that has been used to calculate the return load in Table 3-12 and Table 3-13, was reached, with further decreasing trend.

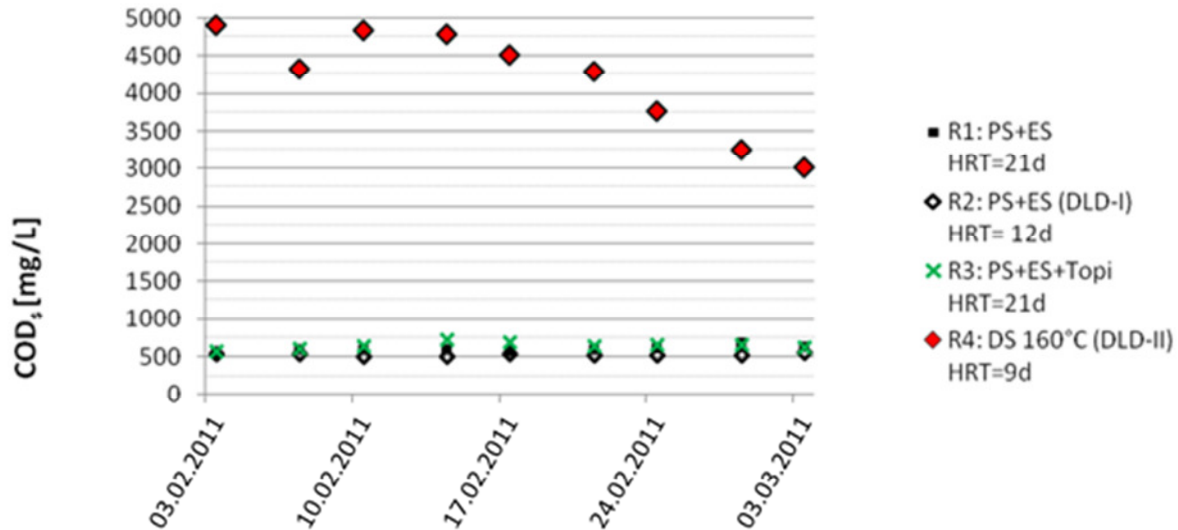

Figure 3-4: COD_s concentrations in the sludge liquor of the pilot scale reactors in IMP-II.

The aerobic degradability of the COD_s in the sludge liquor was determined in modified Zahn-Wellens-Tests at the ISWW. These tests were carried out with activated sludge as inoculum with a duration of 72 h that is even longer as the hydraulic retention time in the aeration tanks. Generally 50 ml activated sludge were mixed with sludge liquor in aerated batch reactors. The sludge liquor from the reactors with THP was diluted in order to avoid a vast deviation of the COD_s concentrations in the beginning of the test. There were also batch reactors filled with activated sludge only and without substrate in order to create a blank value and ethylene glycol was used as the reference material for the degradation.

As shown in Figure 3-5 the degradation of COD in the Zahn-Wellens test of IMP-II proceeded non-linear. The first samples were taken after 3 hours and in the first 24 hours the COD degradation is high, then it decreased and the concentration asymptotically approached the residual COD concentration after 72 h. The degradation of the reference with ethylene glycol was 94%.

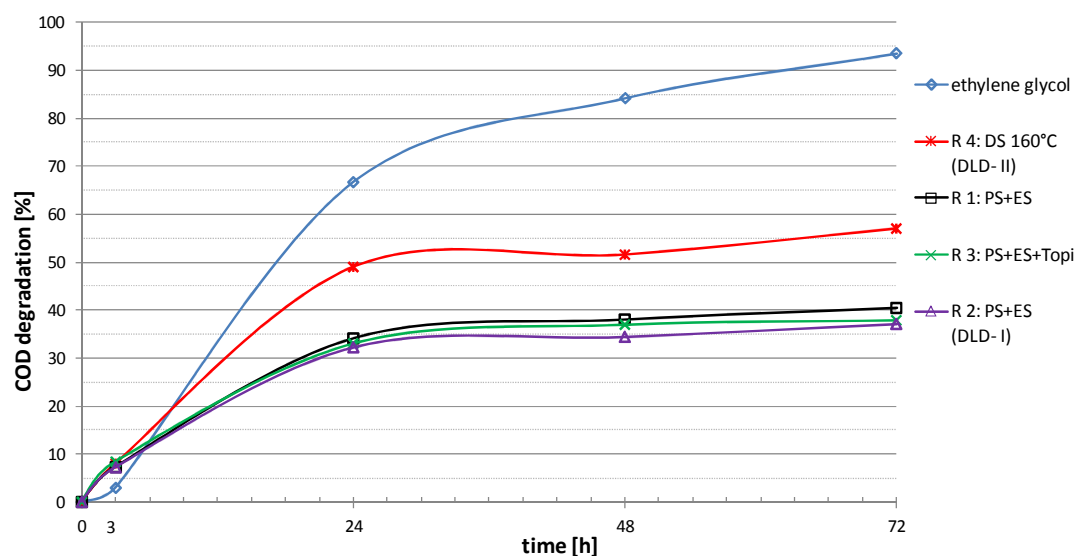

Figure 3-5: CODs-degradation of the reference and the sludge liquor from the reactors in IMP-II.

The results of the modified Zahn-Wellens-Tests as well as the resulting concentrations of refractory COD are listed in Table 3-13. Although the COD degradability in the sludge liquor of the DLD-II reactor was higher compared to that of the reference reactor (in percentage), the concentration of refractory COD was by far the highest among all investigated samples. Additionally, the calculated concentration of refractory COD of the Braunschweig WWTP is shown. The reference reactors and the reactors with co-digestion had approximately 3 to 4.3 mg/L of refractory COD coming from the sludge liquor. The reactors fed with substrates after THP showed calculated refractory COD concentrations of 7 mg/L (LD), 9.1 mg/L (LD + co-digestion) and 12 mg/L in the DLD-configuration taking into account, that the increased concentrations include the basic refractory COD of the reference reactors.

Table 3-13: Average COD_s in sludge liquor, degradability of COD_s determined by a modified Zahn-Wellens test, resulting refractory dissolved COD in sludge liquor and effluent of Braunschweig WWTP.

configuration of the pilot scale reactors	HRT	COD _s	COD-degradability	COD _{refractory} in sludge liquor	COD _{refractory} in effluent of WWTP*
IMP-I	[d]	[mg/L]	[%]	[mg/L]	[mg/L]
R1: PS+ES	20	617	50	309	2.9
R2: PS+ES _{160°C} (LD)	20	1,382	46	748	7.0
R3: PS+ES + GS	20	948	52	458	4.3
R4: PS+(ES+GS) _{160°C} (LD)	20	1,831	47	964	9.1
IMP-II	[d]	[mg/L]	[%]	[mg/L]	[mg/L]
R1: PS+ES	21	603	41	358	3.4
R3: PS+ES+Topi	21	650	38	403	3.8
R2: PS+ES (DLD-I)	12	529	37	332	3.1
R4: DS _{160°C} (DLD-II)	9	3,007	58	1,271	12.0

* calculated refractory COD proportion in the effluent of Braunschweig WWTP (calculated with 600 m³/d sludge liquor and 63,000 m³/d influent to WWTP)

3.4 Dewaterability of digested sludge

The dewaterability of the effluent of the reactors was analysed, in order to quantify the impact of co-digestion and thermal hydrolysis on the dewaterability of digested sludge [Kopp, J.; 2001]. Sludge is a suspension containing various types of water, which are distinguished by type and intensity of their physical bonding to the solids. In general four different types of water can be determined (see Figure 3-6).

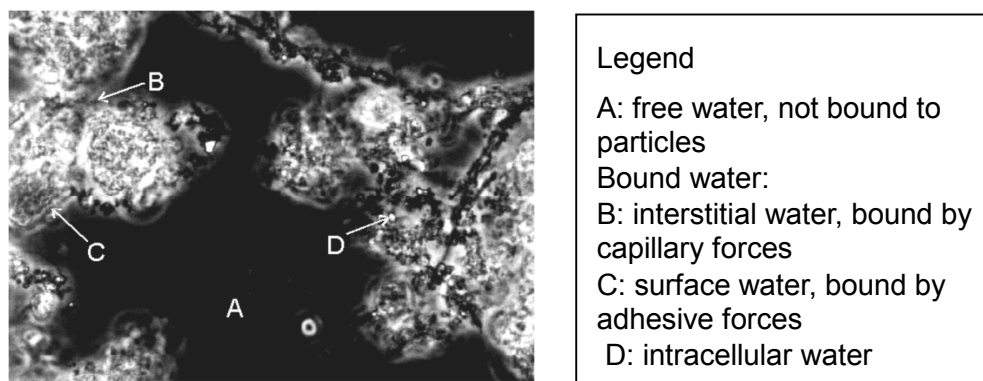

Figure 3-6: Types of water in sewage sludge [Kopp, J.; 2001].

Bound water, i.e. surface water, interstitial water and intracellular water can only be removed thermally. Free water, which is not bound to particles, can be separated mechanically, for example by centrifugal forces or filtration. Water distribution can be measured by thermo-gravimetric and dilatometric tests. The measuring instruments have to be adjusted and calibrated, so that a direct statement can be made concerning the maximum total solids content in the sludge cake after mechanical dewatering.

For thermo-gravimetric measurements the sludge sample is dried very slowly at 35°C and a constant flow of dried air. The water distribution can be derived from the curve of the drying rate in dependence on the ratio $\text{mass}_{\text{water}}/\text{mass}_{\text{TS}}$ (moisture content) of the sample. Figure 3-7 shows the drying rate of digested sludge with a hydraulic retention time of 12 days, the first reactor of the DLD-configuration. Chronologically seen, the drying curve starts at the top right-hand corner with high moisture content and ends, when all water has dried from the sample. As long as free water exists in the sludge sample, the drying rate is linear. At point A the drying rate decreases, because of the capillary bonding of the interstitial water to the sludge and the calculated tangent does not describe the curve anymore. Point A marks the end of the evaporation of free water.

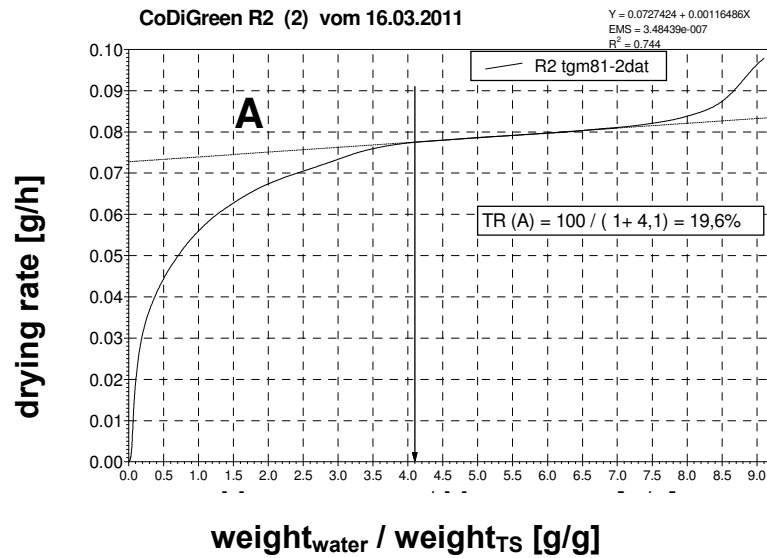

Figure 3-7: Drying rate and TR(A) of digested sludge with a hydraulic retention time of 12 days (R2: DLD- I).

Figure 3-8 shows the results of the thermo gravimetric analyses from digested sludges of all pilot scale reactors and the results of conditioning in IMP-II. According to the impact of co-digestion, ensiled grass (R3) increased the dewaterability significantly whereas ensiled topinambur diminished the dewaterability marginally compared to the dewaterability of the reference reactors. The thermal hydrolysis increased the dewaterability significantly in LD- and DLD-configuration.

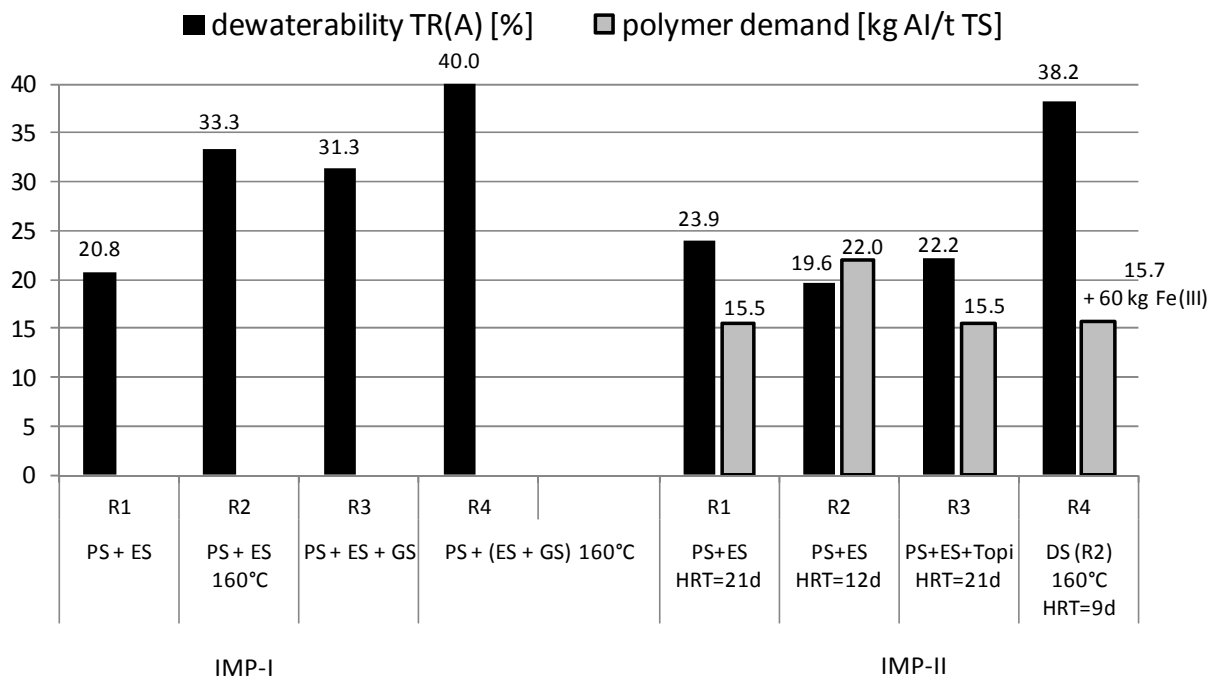

Figure 3-8: Dewaterability of the digested sludge in IMP- I and IMP- II.

Although not being a part of the research project a unique conditioning of the digested sludge in IMP-II was carried out with the same polymer as used in the full scale dewatering at KWS. In terms

of DLD-configuration there was a strong impact on the polymer demand of the digested sludge from both reactors. The reduction of the sludge retention time to 12d in the first DLD reactor (R2) increased the demand of polymer up to 22 kg active ingredient per ton TS compared to 15.5 kg active ingredient in the reference R1. In order to get flocks in the effluent from the DLD-II reactor (R4) a pre-conditioning with coagulation aid was carried out. A sufficient flocculation of the DLD sludge was observed with the addition of 60 kg Fe(III) and 15.7 kg active ingredient of polymer. Nevertheless the DLD-configuration could significantly reduce the quantity of used polymer by half (if related to the overall mass of TS) and the output of dewatered sludge by two-thirds in consequence of the high degradation of volatile solids. These promising results should be verified in further research taking into account the variety of parameters that have an impact on dewatering.

4 Research program of full-scale trials

4.1 Preliminary tests

Prior to the performance of the IMP in full-scale, the flow metering of the whole digestion system (sludge in- and output, biogas produced) was checked for its consistency. Although the measurements of the separate output streams of the digesters were identified as weak points, the entire system could be completely balanced because the relevant flow metering could be proved to be reliable.

The decision for the chosen co-substrate used in the full-scale trials based on the same preliminary tests as for the lab-scale trials (see chapter 2.1). Based on this and due to its availability, ensiled grass has been chosen as co-substrate for the full-scale trials.

4.2 Set-up of the full-scale trials

The full-scale trials have been performed in the three digesters of the WWTP of Braunschweig. All three digesters have been cooled down to mesophilic conditions to assure the comparability to the lab-scale trials. The grass was harvested on fallow lands of the former sewage fields close to the WWTP.

All digesters were fed with the same raw sludge (mix of primary and excess sludge) by a time-controlled feeding unit. Corresponding to the size of the digesters, they received 20% (digester 1) and 40% (digester 2 and 3) of the total raw sludge quantity. Digester 1 was additionally fed with ensiled grass; digester 2 received no co-substrates and was used as reference. Digester 3 additionally received grease which was already used as co-substrate in the past (see Figure 4-1 for a schematic overview). The following Table 4-1 gives an overview on the quantity and the TS- and VS-concentrations of the raw sludge and the co-substrates.

Table 4-1: Properties and quantities of sludge and co-substrates used in full-scale.

	TS [%] mean (min-max)	VS [%TS] mean (min-max)	Q [m ³ /d] mean (min-max)	VS _{added} by sludge [kg/d] mean (min-max)	VS _{added} by Co-substrates [kg/d] mean (min-max)
Raw sludge	5.02 (3.64 - 6.46)	81.5 (79.0 - 84.3)	516 (101 - 737)	4,230 (842 - 5,750)	366 (0 - 727)
Ensiled grass	54.8 (20.7 - 75.3)	89.1 (79.5 - 92.8)	600 - 1,000 kg/d	8,470 (1,680 - 11,500)	--
Grease*	Mean: 1.2	Mean: 90	15.0 (0 - 76.4)	8,470 (1,680 - 11,500)	162 (0 - 825)

*only sporadically analysed due to sampling- and analytical difficulties related to the behaviour of grease; values given are mean values of an analytical series of the ISWW

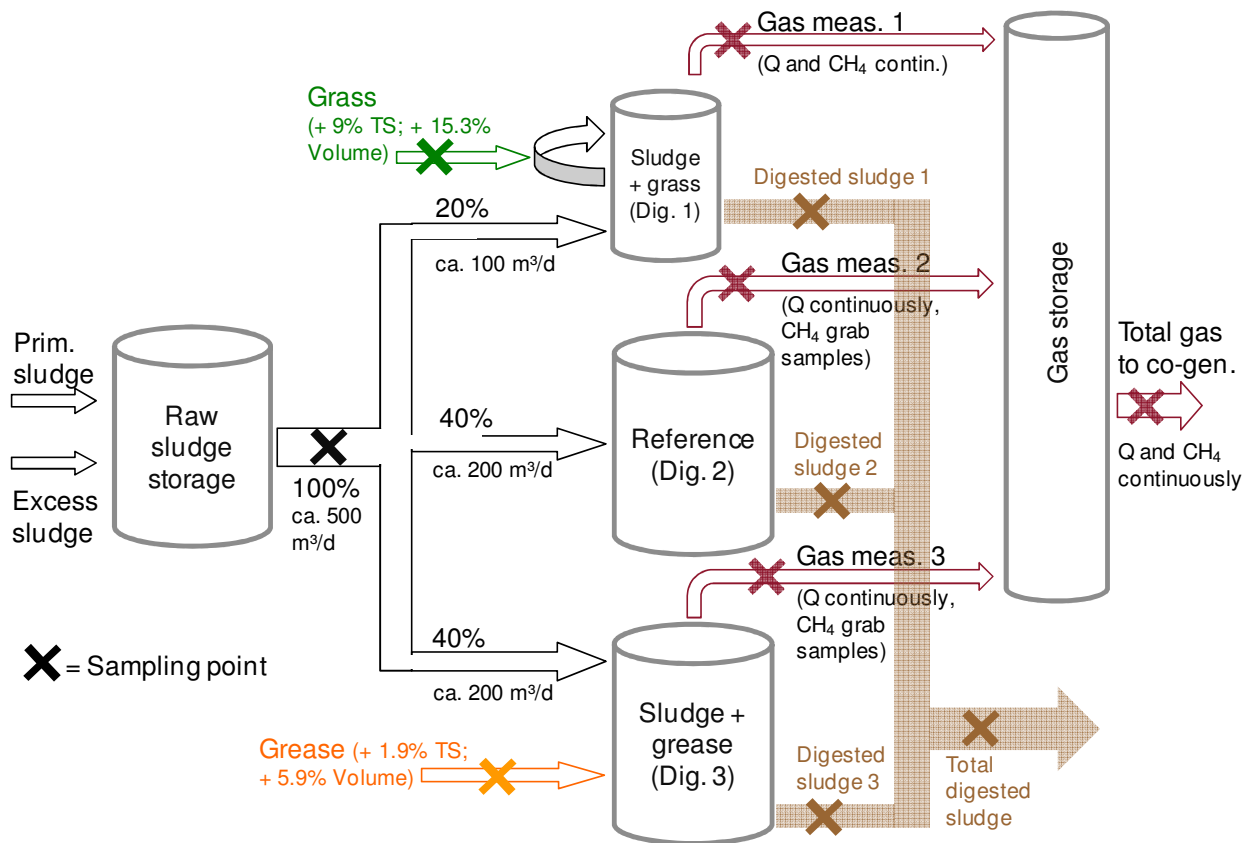

Figure 4-1: Schematic overview on the set-up of the trials and relevant sampling points.

The addition of ensiled grass was 5-10% additional TS to digester 1 (see Figure 4-2), corresponding to a quantity of fresh substrate of 600 – 1,000 kg/day. The mean grease addition to digester 3 was 15 m³/day, corresponding to approximately 2% additional TS. The following Table 4-2 gives an overview on the operational parameters of the three digesters.

Table 4-2: Relevant operational parameters of the three digester towers during the IMP.

Digester	Volume	HRT* mean (min – max)	HRT (20d-mean) during IMP	Type of substrate	Proportion of co-substrate during IMP, mean values	
					%TS	%Volume
1	2,100 m ³	17.5 (14.9 - 21.4)	16.5	Raw sludge + ensiled grass	9	15.3**
2	4,450 m ³	21.8 (18.6 - 26.4)	20.5	Raw sludge only	-	-
3	4,450 m ³	20.3 (17.5 - 23.9)	19.2	Raw sludge + grease	1.9	5.9

*during the whole trials; 20d mean values

** Incl. flush water (0.9% additional volume of grass without flush water)

During the IMP (13.06. to 31.07.), the mean raw sludge quantities to be processed were higher than the mean quantities during the whole trials, leading to a slight reduction of the HRT compared to the whole trials. Even if the volume of the ensiled grass added to tower 1 was comparably low, the co-digestion had a notable influence on the HRT due to the water (15-20 m³/d) needed to flush the ensiled grass into the digester tower (see also chapter 4.5.1).

Compared to the lab-scale trials, the variability of the HRT in full-scale was higher due to the given changes in the quantity and quality of raw sludge and co-substrate. Nevertheless, all fluctuations occurred slowly with no abrupt changes. The ratio of ensiled grass (related to the TS of the sludge) fed to digester 1 is given in Figure 4-2.

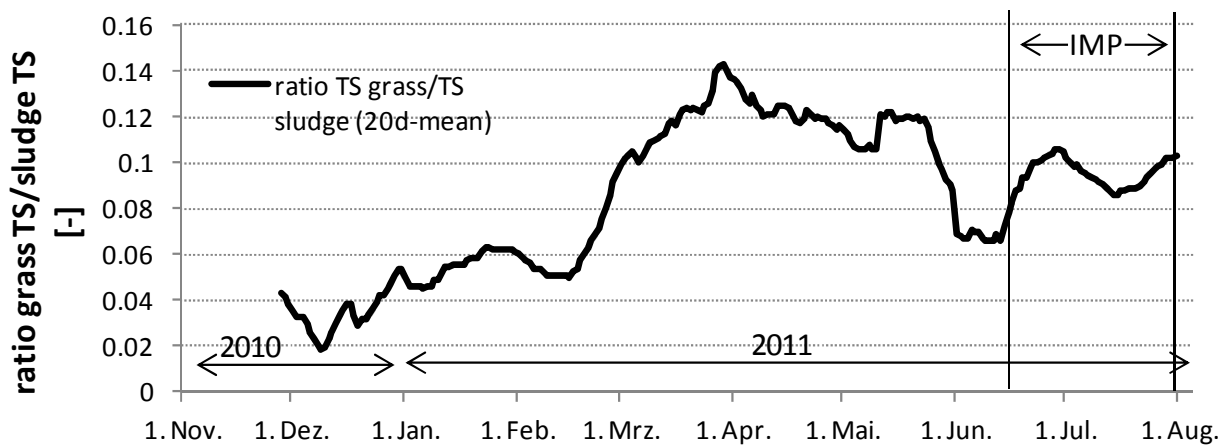

Figure 4-2: Ratio of ensiled grass in digester tower 1 (related to TS of the sludge).

In Feb. 2011, the addition of grass was increased to 1,000 kg of fresh substrate per day, leading to a TS-ratio of over 12% as the available sludge quantities were comparably low at this time. During the IMP, the TS-ratio of ensiled grass was relatively constant at 9%.

4.3 Analytical program

During the whole full-scale trials, the analytical program as described below (Table 4-3) was performed. The parameters analysed were the same as during the lab-scale trials. Based on this program, all three digester towers could be evaluated and balanced separately (see also Figure 4-1 for the set-up and the sampling points).

Table 4-3: Analytical program of the full-scale trials; routine and special analyses.

Parameter	Sampling point	Frequency
Q	RS, DS, T1, T2, T3, Co	daily
DS and VS	RS, DS, T1, T2, T3, Co*	2x/week
COD and COD _s	RS, DS, T1, T2, T3	2x/week
TOC	RS, DS, T1, T2, T3, Co*	1x/week
DOC and IC	RS, DS, T1, T2, T3	1x/week
TKN and total P	RS, DS, T1, T2, T3, Co*	1-2x/week
NH ₄ -N and PO ₄ -P	RS, DS, T1, T2, T3	2x/week
Ca, Mg, K (total and dissolved)	DS, T1, T2, T3	1x/week
Organic acids	T1, T2, T3	1x/week
Gas quantity	T1, T2, T3, Sum of towers	
Gas quality (methane content)	T1, T2, T3, Sum of towers	Daily; T2 and T3 weekly since 05/11

Special analyses:

Parameter	Sampling point	Frequency
Heavy metals (Cr, Zn, Cd, Pb, Ni, Cu, Hg)	T1, T2, T3, Ensiled Grass	1x/month
TR(A)	T1, T2, T3	3x during the trials
Organic pollutants (LUFA)	RS, DS, T1, T2, T3, Co	June and August 2011

*Grease has been analysed only sporadically; T=tower, RS=raw sludge, DS=digested sludge, Co=Co-Substrates

4.4 Data evaluation

The data evaluation of the three full-scale digesters also based on mass balances as described in chapter 3.1. The parameters related to gas production and -measurements (COD- and TC-balances) have only been balanced for the IMP, since the quality of the gas measurement of all towers was stable during this period. To assure comparability, also the parameters that are independent from the gas production (N and P) were balanced for the IMP only.

As for the lab-scale trials, the specific biogas yield [NL/kg VS] of the three digester towers has been related both to the total added volatile solids (VS_{added}) as well as to the added volatile solids of the sludge (VS_{sludge}).

4.5 Operational procedures during full-scale trials

The following chapter gives an overview on the specific materials and methods of the full-scale trials with regard to the used substrate; its processing and the feeding of the towers. Since one of the goals of the full-scale trials was also to gain experience with regard to operational questions, these aspects are also included.

4.5.1 Harvest and silage of grass

In June and September 2010, 24 ha of the former sewage fields were harvested. The grass yield was 11 t/ha fresh substrate for the 1st and 5 t/ha for the 2nd harvest; corresponding to a VS-yield of ca. 8 t/ha*a under extensive cultivation. Cutting, drying/swathing and shredding of the grass was performed within two subsequent days. The grass was then fed into silage tubes. It has to be mentioned that the actual size of the shredded grass was 5 – 30 mm (see Figure 4-3) compared to



Figure 4-3: Size of the ensiled grass.

8 mm as planned originally (and compared to approx. 5 – 8 mm in lab trials). It is to assume that this might have a certain effect on the grass degradation and the gas production (see discussion in chapter 5.2).

The silage process was stable and no negative effects such as mould were observed. After at least 6 weeks, the ensiled substrate could be used in the digester tower.

During the TC-meeting on 24.03.2010, it was discussed if there are any losses of TS and VS during the whole harvest- and silage process. According to a literature study (see presentation at TC meeting, 05.11.2010), total losses of about 5% as CO₂ can be expected. Since there is no other practical way to conserve such amounts of grass, these minor losses have to be accepted.

4.5.2 Feeding and operation of the digester towers

The feeding of the co-digestion tower was done with a Quickmix (Vogelsang GmbH, see Figure 4-4); a feeding device usually used to feed biogas plants. The Quickmix itself was loaded by a mixer/feeder of 12 m³ (manufacturer: Siloking) which was manually (wheel loader) fed with silage once a day. Within approx. 45 minutes, the daily amount of silage needed (600 or 1,000 kg of fresh substrate) was then mixed into the sludge stream. To avoid problems related to frost, the whole equipment was encased with a wooden “shack” that was heated during winter.

Since the ensiled grass could not be directly added to the sludge stream, treated wastewater (“recycling water”) had to be used to flush the ensiled grass into the sludge. The amount of water needed was about 15-20 m³/d, depending on the grass quantity. As mentioned above (chapter 4.2), this had a notable influence on the hydraulic retention times in digester 1. Consequently, the feeding procedure has to be optimised if the co-digestion would be implemented continuously.

During the operation of the co-digestion tower, different technical problems were observed. During the first months of the full-scale trials, the grass occasionally led to the formation of a floating layer of grass and sludge in tower 1. As a consequence, the digested sludge could not be discharged via the overflow system, but had to be discharged via the outlet at the bottom of the digester tower. Moreover, the floating layer also disturbed the radar-measurement of the filling level of the digester tower. Temporarily (when the floating layer was too big), the level of sludge had to be lowered to avoid sludge and grass entering the gas system, leading to a further reduction of the HRT during these periods.

As a consequence of these issues, the heating sludge turnover system was modified. After modification, the heated sludge was returned/pumped directly at the surface of the tower, thus reducing the formation of potential floating layers.

Other operational problems as observed during the trials were the increased wear and tear of the “mono-muncher” installed in the sludge turnover system and an increased clogging of the sieving system of the digested sludge before dewatering.

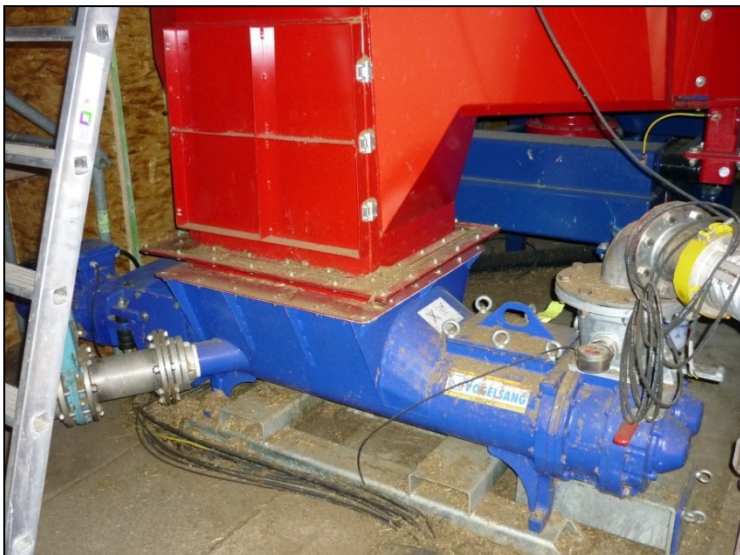

Figure 4-4: Quickmix and mixer feeder on the WWTP of Braunschweig.

5 Results of full-scale trials

5.1 Mass balances

During the IMP of the full-scale trials, mass balances for the relevant parameters COD, TC, N and P were established for all three digester towers separately as described in chapter 2.4.

The COD mass balances during the IMP are given in Table 5-1.

Table 5-1: COD-Mass balances of the full-scale reactors (all values in [t]).

(IMP 13.06.-31.07.2011)	COD _{reactor, start}	COD _{in}	COD _{reactor, end}	COD _{CH4}	COD _{effl}	difference ($\sum \text{COD}_{\text{out}} - \sum \text{COD}_{\text{in}}$)	
Digester 1 (sludge + grass)	60.7	427	59.6	196	194	-38.1	-8.9%
Digester 2 (sludge)	129	740	126	379	344	-20.0	-2.7%
Digester 3 (sludge + grease)	126	754	129	370	370	-11.0	-1.5%

With a difference of 1.5 - 9%, all COD mass balances could be closed very satisfying for the full-scale approach. Also, the differences were in the same range as the lab-scale ones.

The same method is used to calculate the mass balances of TC, TKN and P. The final results for all mass balances are given in Table 5-2.

Table 5-2: Mass balances of the parameters COD, TC, TKN and P.

	COD	TC	TKN	P
Digester 1 (sludge + grass)	-8.9%	25.3%	-4.0%	29.9%
Digester 2 (sludge)	-2.7%	16.7%	-2.8%	-8.4%
Digester 3 (sludge + grease)	-1.5%	18.3%	3.9%	1.3%

The mass balances of the nutrients can be closed within a range of +/- 8%, which confirms the accuracy of the COD-balances. Only the P-balance of digester 1 could not be closed.

The differences of the TC-balances are over 15% for digester 2 and 3 and over 25% for digester 1. After an intensive check of the raw data, a causal correlation could not be identified. Based on the plausibility of the N- and P-balances – which indicate the correct assessment of the sludge quantities – and based on the COD-balances which give an additional proof for the reliability of the gas measurements, either the values of TC in the output were too high or those of the input too low.

The volumetric loading and the VS-degradation ratios of all three digesters are given in Table 5-3.

Table 5-3: Results of the mass balances of volatile- (VS) and total solids (TS) during the IMP.

IMP (13.06.-31.07.)	HRT	Volumetric Loading	VS- degradation	TS-reduction
	[d]	[kg VS/m ³ *d]	[%]	[%]
Digester 1 (sludge + grass)	16.5	2.04	45%	35%
Digester 2 (sludge)	20.5	1.76	48%	40%
Digester 3 (sludge + grease)	19.2	1.79	45%	37%

Due to the addition of grass, the volumetric loading in digester tower 1 is higher than in the other two towers. In contrast, the grease addition had almost no effect on the volumetric loading. Presumably related to the highest HRT of 20.5 days, the degradation of VS and the TS-reduction in the reference digester 2 exceed the ratios of the other two digesters considerably. Compared to the lab-scale trials where the VS-degradation reached approx. 50-60% and the TS-reduction ca. 40-50%, the results obtained during the full-scale trials are comparably low.

The inconsistencies of the mass balances (Table 5-2) and the notable differences between lab- and full-scale trials as described in the previous paragraph cannot be related to a single reason. As a consequence of the frequency of the full-scale sampling- and analysis (one or two samples/week only), mean values had to be used to calculate the balances. In contrast, every single batch of in- and output could be analysed during the lab-scale trials – and thus, content and dynamics of the reactors were exactly known. This aspect might partially be a reason for some of the inconsistencies.

Especially with regard to the comparison to the lab-scale trials (Table 5-3), it also has to be considered that operational parameters such as the HRT, the mixing and the properties of the co-substrate used were different. Further research is needed to quantify the influence of these aspects on the differences observed.

5.2 Performance of the biogas production

The overall performance of the three digester towers, evaluated by the concentrations of organic acids, was very stable over the whole period of the full-scale trials. Table 5-4 shows the concentration of organic acids (acetic acid equiv.) as the reference parameter for the process stability.

Table 5-4: Organic acids (as acetic acid equiv.) in the three digester towers; measured 2x/week.

Full-scale trials from Nov. 2010 to August 2011	Acetic acid equiv. [mg/L]		
	Min	Max	Mean
Digester 1 (sludge + grass)	11.0	70.0	27.9
Digester 2 (sludge)	8.0	74.0	25.8
Digester 3 (sludge + grease)	9.0	68.0	27.2

The following Figure 5-1 shows the specific biogas production per kg VS_{added} of all three digester towers. The green line indicates the 20d mean values, confirming a constant gas production in all three towers during the IMP. Referring to the degradation ratios given in Table 5-3, it is comprehensible that the reference tower 2 shows the highest specific gas productions.

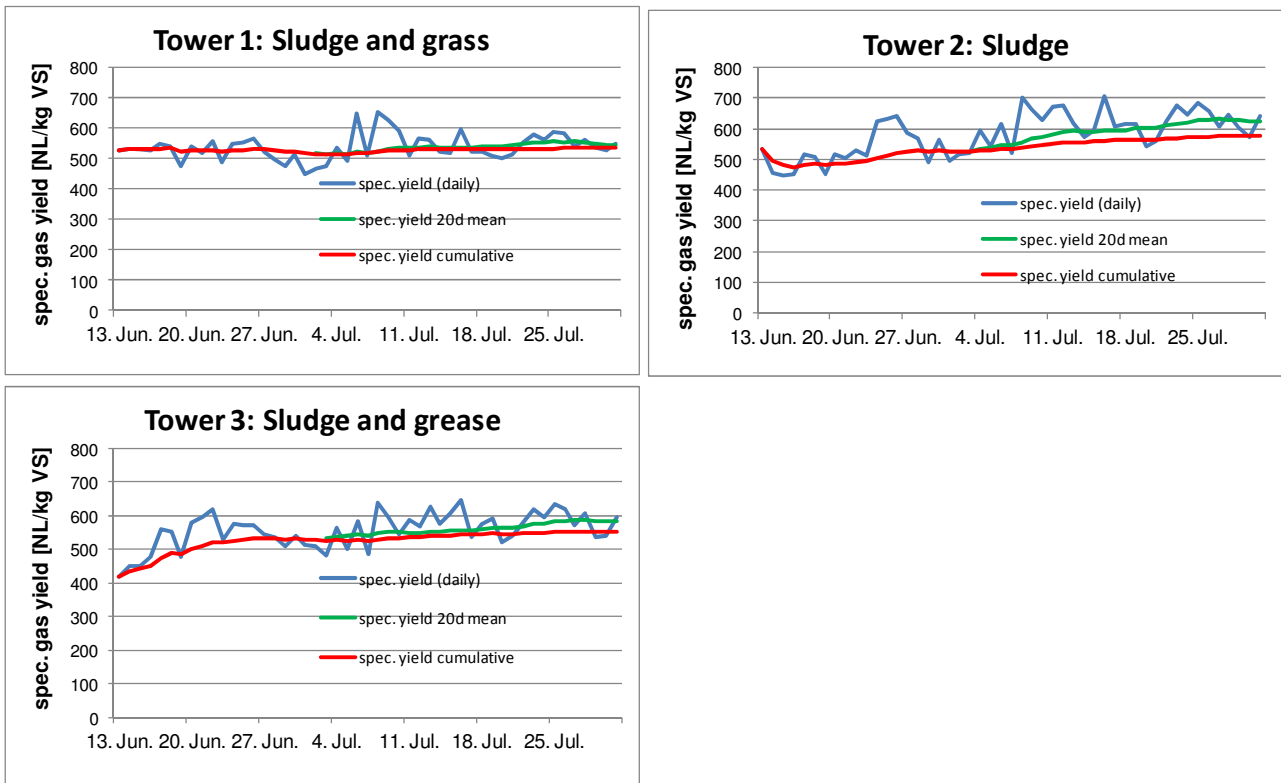

Figure 5-1: Gas yield [NL/kg VS_{added}] of the three digester towers during the IMP.

The mean specific gas yields during the IMP, calculated as for the lab-scale trials (see chapter 3.2), are given in Table 5-5.

Table 5-5: Specific gas yield and influence of co-substrates on the gas yield.

IMP (13.06.-31.07.) reactor	HRT [d]	methane content [%]	specific gas yield [NL/kg VS]			increase by Co-Digestion	
			VS added	VS sludge	VS removed	[%]*	[%]**
Digester 1 (sludge + grass)	16.5	61.8	534	589	1223	-8%	2%
Digester 2 (sludge)	20.5	62.5	578			-	-
Digester 3 (sludge + grease)	19.2	63.7	553	565	1248	-4%	-2%

*related to total VS added; ** related to VS sludge

The co-digestion of approx. 10% additional VS by ensiled grass led to an increase of the gas production of only 2%, related to the VS of the sludge. With regard to the total added VS, the co-digestion led even to a decrease of 8%, which corresponds well with the lower degradation ratio of digester 1 (see Table 5-3).

The positive impact of the co-digestion of ensiled grass as observed in lab-scale – an increase of 23% with regard to the VS of the sludge – could not be confirmed in full-scale. At least partially, this might be related to the reduced HRT in digester 1, leading to a reduced gas production of the sludge itself, which overlaps with the gas production of the added grass. Additional reasons for the differing results between lab- and full-scale trials might be related to the different size of the ensiled grass of some millimetres in lab-, but 2-3 cm in full-scale, as well as non-complete mixing of the reactor.

Nevertheless, the increase of 23% as achieved in lab-scale can be regarded as the maximum potential of the co-digestion (“benchmark”). Provided that the conditions and the process parameters of the lab-scale trials can also be realised in full-scale, this benchmark could at least partially be reached.

The methane content was lower in the co-digestion tower of the full-scale trials (61.8% compared to 62.5% in the reference). Since a mono-digestion of grass leads only to an expected gas yield of 54% [KTBL 2005], it is comprehensible that the methane content in the co-digestion tower is lower than in the reference.

This result is in contrast to the observations of the lab-scale trials, where a notable increase of 67.9% in the co-digestion reactor (compared to 63.6% in the reference reactor) was observed. If this promising result can be reproduced, it can be assumed that – under the given conditions – ensiled grass might serve as a “catalyst”, leading to an activation and optimisation of the process.

Thus, further research is needed to clarify the differences between lab- and full-scale with regard to gas quality and -quantity, focusing on the influence of the co-substrate and its properties, the HRT and the operation of the reactors.

5.3 Organic pollutants and return loads

5.3.1 Organic micropollutants

The results of the sum parameters for adsorbable organic halogen compounds (AOX), Nonylphenol a-c (NP), perfluorinated surfactants (PFT=PFOA and PFOS) and polycyclic aromatic hydrocarbons (PAH(16)) are given in Table 5-6 as well as the measured concentrations of DEHP as a leading parameter for phthalates and Benz-a-pyrene (B(a)P) as the leading parameter for PAH.

Table 5-6: Results of the analysis of organic micropollutants (recovery rate typically > 75%, info LUVA).

	TS	AOX	NP	PFOA	PFOS	DEHP	PAH ₍₁₆₎	B(a)P	
	[%]	[mg/kgTS]	[mg/kgTS]	[mg/kgTS]	[mg/kgTS]	[mg/kgTS]	[mg/kgTS]	[mg/kgTS]	
Series 1 June 2011	Primary sludge	4.07	94.8	3.04	<0.01	<0.01	26.9	1.71	0.11
	Excess sludge	5.55	160	<0.5	<0.01	<0.01	30.0	1.13	0.07
	Digester 1 (sludge + grass)	3.20	195	1.66	<0.01	0.014	25.9	1.25	0.09
	Digester 2 (sludge)	3.51	190	2.20	<0.01	0.019	26.4	1.16	0.08
	Digester 3 (sludge + grease)	3.65	191	2.41	<0.01	0.016	27.0	1.03	0.07
	Ensiled Grass	58.8	<50	<0.5	<0.01	<0.01	<0.01	<0.05	<0.05
	[%]	[mg/kgTS]	[mg/kgTS]	[mg/kgTS]	[mg/kgTS]	[mg/kgTS]	[mg/kgTS]	[mg/kgTS]	
Series 2 Aug 2011	Primary sludge	2.15	99.9	1.54	<0.01	<0.01	26.1	1.81	0.12
	Excess sludge	6.75	131	<0.5	<0.01	0.012	32.2	1.33	0.07
	Digester 1 (sludge + grass)	2.30	157	2.63	<0.01	<0.01	23.2	1.84	0.10
	Digester 2 (sludge)	2.56	154	2.87	<0.01	<0.011	28.1	2.08	0.12
	Digester 3 (sludge + grease)	2.56	172	3.17	<0.01	0.01	23.7	2.02	0.11
	Ensiled Grass	52.9	<50	<0.5	<0.01	<0.01	<10	<0.05	<0.05
Grease	3.00	123	<0.5	<0.01	<0.01	33	2.02	0.09	
Limit of Quantification	-	50	0.5	0.01		10	0.05*	0.05	
Limit values sludge ord.	-	400	-	Sum PFT: 0.2		-	-	1	

*for each PAH

All values were clearly below the limits of the amended sewage sludge ordinance. The influence of grass on the organic pollutants is negligible.

The results of the pharmaceutical compounds (1 sample taken from each reactor) are showed in Annex 7.4 and do not exhibit any significant variation between each reactor.

5.3.2 Heavy metals

Heavy metals have been analysed monthly during the whole full-scale trials. The mean values of the heavy metal analyses are given in Table 5-7.

Table 5-7: Mean concentrations of heavy metals in the three digester towers and in ensiled grass.

Heavy metals [mg/kg TS]	Cd	Cr	Cu	Ni	Pb	Zn	Hg	P ₂ O ₅ - Conc.
Limit P ₂ O ₅ > 5% TS*	3.0	120	850	100	150	1800	2.0	[%-TS]
Digester 1 (sludge + grass)	1.39	25.6	224	21.5	34.0	848	0.57	6.58
Digester 2 (sludge)	1.55	27.4	260	23.7	36.9	959	0.52	6.89
Digester 3 (sludge + grease)	1.51	27.6	256	24.3	36.3	947	0.55	6.91
Grass	0.50	32.5	9.88	21.9	5.27	92.7	0.19	-

*according to the amended sewage sludge ordinance

There was no exceedance of any limit value during the project. Due to the comparably low concentrations of all heavy metals in ensiled grass, it has no negative influence on the heavy metal concentrations in the sludge.

5.3.3 Return loads

The concentrations of COD_s, NH₄-N and PO₄-P in the liquid phase of all digester towers have been regularly measured. The mean values during the whole full-scale trials are given in Table 5-8.

Table 5-8: Concentrations of COD_s, NH₄-N and PO₄-P in the liquid phase.

All values in [mg/L]	COD _s	NH ₄ -N	PO ₄ -P	Number of samples
Digester 1 (sludge + grass)	1890	1150	224	76
Digester 2 (sludge)	1990	1360	237	76
Digester 3 (sludge + grease)	1970	1330	241	76

There was no obvious correlation between the addition of co-substrates and the return loads in the sludge liquor. Due to the diluting effect of the flush water, the concentrations in digester 1 are slightly lower than in the other two digesters. A slight increase of the resulting return loads of about 5-10% due to the grass addition can be assumed for COD_s and PO₄-P, but this value lies within the usual precision range of the balances and thus, cannot be regarded as significant.

A specific evaluation, e.g. of the refractory COD, was not performed in full-scale.

5.4 Dewaterability of digested sludge

The same protocol as in the lab-scale trials (see chapter 3.4) has also been used to assess the dewaterability of the full-scale sludges. The results of the three analyses, including the mean values, are given in Figure 5-2.

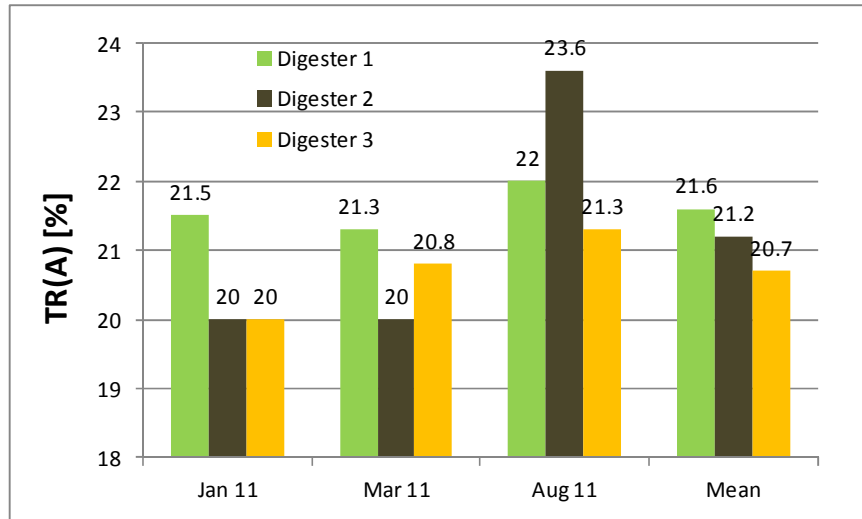

Figure 5-2: Results of the thermo gravimetric analysis (TR(A)-values)

The dewaterability of the reference sludge (tower 2) with 20.0% TR(A) in Jan and March and 23.6% in August is generally low, compared to the values usually achieved on the WWTP. This might be related to the mesophilic operation of the digester towers during the full-scale trials.

The dewaterability of the sludge of digester 1 is only slightly higher (21.5% and 21.3%) or even lower (22.0% in August) than the dewaterability of the reference. Referring to the mean values, the TR(A)-value was only increased by 0.4% due to the addition of the co-substrate.

In general, there is no consistent result or tendency regarding the dewaterability. The promising results of the IMP-I of the lab-scale trials (an increase of the TR(A)-values from 20.8% (reference) to 31.3% in the co-digestion reactor) could not be confirmed in full-scale. Probably, this is also related to different properties of the co-substrates used.

Due to the high relevance of this aspect, the influence of grass on the sludge dewaterability should also be evaluated within further research.

6 Summary and outlook

Results and comparison of lab- and full-scale trials

In the presented research work, lab- and full-scale trials were carried out in order to quantify the impact of co-digestion and thermal hydrolysis process on digestion. In **lab-scale**, the addition of ensiled grass as well as ensiled topinambur was evaluated. The added quantities of the co-substrates were 10% related to the TS of the sludge. Moreover, the thermal hydrolysis process (THP) was realized in a pre-treatment of waste activated sludge with and without ensiled grass in the LD-configuration as well as an integrated treatment in a series connection of two reactors in the DLD-configuration. In **full-scale**, only the co-digestion of ensiled grass has been evaluated. The addition was also approx. 10% related to the TS of the sludge.

In lab-scale, the co-digestion of ensiled grass increased the specific gas yield by 23% (without THP) and 27.2% (with THP) if the gas production is only related to the TS-content of the sludge. The co-digestion of topinambur led to a comparable increase in the specific gas yield by 19.8%. The thermal disintegration of sludge increased the specific gas yield by 8.4 percentage points in the LD and 18.2 percentage points in the DLD-configuration. Additionally the methane content of the biogas in IMP-I was 4.3 to 5.2 percentage points higher compared to the reference if ensiled grass was co-digested. In full-scale, the co-digestion of ensiled grass led to an increase of the specific gas yield of only 2%, related to the VS_{added} of the sludge. The grass addition led to a slight decrease of the methane content from 62.5% to 61.8%.

The degree of degradation of volatile solids in lab-scale amounted to 60.4% in the LD-configuration and to 75.6% in the DLD-configuration and thus showed a significant dependency on the thermal hydrolysis process, if compared to the reference reactors (53.3% and 54.3%). In contrast to this, the degradation of VS in full-scale was lower than in lab-scale, but still within the common range of a full-scale digester (44.9% with co-digestion and 47.9% in the reference).

In general the thermal hydrolysis process as performed during the lab-scale trials had a positive impact on the dewaterability of digested sludge. The THP in LD-configuration caused an enhancement of 12.5 percentage points and of 14.3 percentage points in the DLD-configuration. The highest dewaterability was observed with 40% TR(A) for the digestion of ensiled grass and excess sludge after THP in the LD-configuration. The co-digestion of ensiled grass without THP still led to an increase of the TR(A) from 20.8% to 31.3%.

As indicated by the measured TR(A)-values, the ensiled grass had almost no influence on the dewaterability in full-scale. During two of three series, only a slight increase from 20.0% to over 21.5% has been observed, whereas in the 3rd series, a decrease of about 1.5% has been observed. Thus, the promising results of the lab-scale trials (a TR(A) of 31.3%) could not be confirmed in full-scale.

In lab-scale, the THP-process showed a significant effect on the COD_s concentration in the effluent of the digesters, which was increased by 123% (LD without ensiled grass), 93% (LD with ensiled grass) and 398% (DLD-II) compared to the references. After aerobic post-treatment (modified Zahn-Wellens Test) of the effluent streams the refractory COD_s concentration was still increased by 142% (LD without ensiled grass), 110% (LD with ensiled grass) and 255% (DLD-II) compared to the reference reactors. In full-scale, grass as well as grease as co-substrate had no significant influence on the return loads of the sludge.

Although the thermal hydrolysis process showed a temporary effect on the release of some heavy metals, the concentrations decreased again after digestion, so that the limit values of the sewage sludge ordinance were not exceeded at any time. Also the concentrations of the analyzed organic micro pollutants were far below the limit values in all cases, both in lab- and in full scale.

It is to assume that the different results of lab- and full-scale as described above are, amongst other, related to different factors such as the lower HRT in the full-scale digester 1, a different mixing of sludge/grass and the different substrate quality (see Table 6-1). These factors overlap, have an influence on each other and cannot be quantified separately.

Table 6-1 gives an overview on the factors (potentially) leading to the observed differences between lab- and full-scale trials

Table 6-1: Main differences between lab- and full-scale trials; and potential impacts on the results observed.

Factor	Lab	Full	(Potential) impact on...
HRT	20 d	16.5 d	Gas yield of grass and sludge
Size of grass fibres	5-8 mm	up to 3 cm	Reduced degradation, gas yield, gas quality, (floating sludge layer), (dewaterability)
Substrate handling and feeding	Mixing with sludge before feeding	Mixed with flush water	Mixing sludge/grass, degradation, gas yield, phase separation
Use of flush water	No	15 m ³ /d (ca. 15% Vol.)	HRT, loading rate, TS-concentration
Digester mixing	Controllable completely	Floating layer	Degradation, gas yield, phase separation
Sampling strategy	Every batch	1-2x/week	Accuracy of results

Consequently, to verify and quantify the potential impacts, the influence of the relevant factors should be evaluated separately by comparative tests. Beside the technical aspects, it is to assume that the different sampling strategies (1-2 samples/week in full-scale, compared to the complete assessment of *all* substrate batches in lab-scale) also had an influence on the accuracy and the comparability of the results. Within the proposed further research, this aspect should also be considered and optimised.

Technical evaluation of the full-scale trials and recommendations

During the whole full-scale part of the project, various technical problems occurred. The complexity of the installation and the adjustment of all system parts, as well as the installation and calibration of the gas measurements, led to a delayed start of the trials. By the actual start of the grass addition, flush water was needed to mix ensiled grass into the sludge stream, leading to a reduced HRT and thus, to one of the assumed reasons for the different results of lab- and full-scale trials. Furthermore, the grass caused a floating layer in the digester tower, leading mainly to operational problems (potential overflow), but probably also to a reduced degradation due to insufficient mixing. Moreover, the co-digestion led to increased wearing and maintenance of the whole system.

Consequently, with regard to a further (continuous) implementation of the co-digestion of grass, the system has to be optimised. The size of the grass fibres should be reduced to optimise the gas yield, but potentially also to improve the grass/sludge mixing in general. For the same reasons, grass and sludge should be mixed before being added to the digester tower, avoiding the use of flush water. Operating the co-digestion at thermophilic conditions might improve the gas yield as well. If necessary, the stirring- and/or turnover system of the digester should be modified to avoid the formation of a floating layer.

Further research should clarify the hydraulic conditions in the digester with regard to the mixing and the HRT of the different phases. A detailed economic assessment is recommended to evaluate the costs and benefits of the co-digestion of grass.

General recommendations for further research

During the project, different aspects could be identified which should be evaluated within further research projects.

- In future the efficiency of DLD could be further enhanced by dewatering the effluent of DLD-I before THP. Due to a reduced sludge volume the demand of energy for the thermal hydrolysis would then decrease significantly. Further research should also include the verification of the observed increase in the dewaterability of the effluent sludge from LD and DLD. Also the impact of LD and DLD on the demand of flocculation aid should be

investigated.

- Taking the observed positive effects of co-digestion in LD-configuration into account, the co-digestion of ensiled grass within a DLD-configuration is an option of high interest as well.
- A systematic evaluation, especially of the influence of the HRT and the grass size on the gas yield and the influence of the grass on the sludge properties, should be performed in order to identify the best option for the operation of a co-digestion system.
- The addition of higher amounts of co-substrate (e.g. 20, 25, 30%, related to the TS of the sludge) should be investigated regarding the stability of the digestion process at high volumetric loadings.
- The economy of the co-digestion, taking into account all relevant factors, should also be evaluated in detail.

The proposed research will be a further step to completely exploit the high potential of the co-digestion and the THP-process.

7 Annex

7.1 Heavy metals

In accordance with DIN EN ISO 11885 the analyses of heavy metals were performed with a disintegration of the samples with aqua regia, which consisted out of one part nitric acid and three parts hydrochloric acid. The measurements were carried out with an ICP-MS (inductively coupled plasma mass spectrometry).

7.2 Analytical protocol for the analysis of persistent organic micropollutants

The analysis of the micropollutants (see results in chapter 3.3.1 and in chapter 5.3.1) was performed by the LUFA. After freeze drying to remove the water, the PAH were analysed according to the protocol “VDLUFA VII, 3.3.3”, describing the analysis of PAH in sewage sludges. This protocol was modified with regard to the extraction step. Referring to this, the “Advanced Solvent Extraction” (ASE) was used.

The ASE combines the advantages of hot- and cold extraction and uses high pressures and temperatures from 120°C - 180°C. After 10 Minutes of extraction, the analytes are eluted with Hexane and Acetone. The following figure gives an overview on the extraction parameters *specifically used for sludge analysis* (i.e. with a temperature of 120°C, below the temperature used in the Thermo Hydrolysis Process):

Heating time	3 min
Static extraction time	10 min with hot (120°C) solvent
Rinsing (elution) volume	100% of cold solvent
Cycles	2
Temperature	120°C
Solvent mix for rinsing	Hexane 67%/Acetone 33%

Using 67% Hexane and 33% Acetone, the pollutants are effectively eluted, whereas components possibly interfering with the measurement are retained. The results achieved by ASE correspond well with the results of “common” methods such as hot- and cold extraction [Trenkle 1998].

7.3 Analytical protocol for the analysis of pharmaceutical substances

The analyses of the pharmaceutical substances (see results in chapter 3.3.1 and in chapter 5.3.1) were performed by the laboratory of Veolia Environment Research & Innovation (VERI). The extraction from the sludge samples was carried out by Accelerated Solvent Extraction (ASE) at

80°C under 100 bars: 1 gram of sludge was extracted by a solvent mixture water / acetone / methanol (all 3 solvents in same volume quantity, with 2 extraction cycles (the solvent mixture is introduced twice in the sludge sample in order to better extract the targeted compounds). The purification of the extracts before analysis occurs by solid phase adsorption followed by elution in methanol. The methanol is then dried, and the extract is then re-dissolved in 250µL of an adequate solvent (Eau HPLC / Methanol [80 / 20 (V/V)]). The analysis occurs then by liquid phase chromatography coupled with tandem mass spectrometry.

7.4 Pharmaceutical substances - complete set of data

Samples taken 14/03/2011							
CODIGREEN : monitoring of pharmaceutical substances in sludges from Braunschweig reactor (pilot units - IMP-II)							
inlet reactor = mixture primary sludge + activated sludge ("raw sludge")							
inlet reactor after centrifugation = mixture primary sludge + activated sludge ("raw sludge" + centrifugation)							
R1 : outlet reactor 1 = reference digester 21 d HRT							
R2 : outlet reactor 2 = digester 12 d HRT							
R3 : outlet reactor 3 = digester with green biomass codigestion							
R4 : outlet reactor 4 = DLD configuration (12 d HRT digester + 160 °C thermolysis + 9d HRT digester)							
Concentration in ng/g	Limit of quantification	Raw sludge (mixed)	Raw sludge after centrifugation (= solid fraction)	R1 (mesophil digestion, 21d HRT)	R2 (mesophil digestion, 12d HRT)	R3 (mesophil digestion with +10%TS)	R4 (R2 + lysis + mesophil digestion 9d HRT)
DM (g/L)		44,71		26,67	27,77	27,42	11,1
oDM (g/L)		36,75		18,56	19,8	19,38	6,62
Pharmaceutical Compound							
Analgesic /Anti-inflammatory							
Paracetamol	5	233	115	8	< 10 * ; **	< 5 *	1203 ¹
Diclofenac	5	262	154	133	298	153 ¹¹	79
Phenazone	5	41	29	22	31 ²	Non quantifiable ³	73
Antidepressant							
Fluoxetine	10	53	20	16	29	19	29
Anticonvulsant							
Carbamazepine	5	284	177 ⁸	226	497	237 ⁹	384 ¹⁰
Primidone	5	12	9	6	10	6 ⁷	< 10 (4)
Antilipidemic							
Bezafibrate	5	32	23	5	10	6	10
Gemfibrozil	5	< 10 * ; **	< 5 *	< 5 *	< 10 * ; **	< 5 *	< 10 * ; **
Betablockers							
Metoprolol	5	298	184 ⁴	167	365	167 ⁵	264 ⁶
Propranolol	5	30	17	11	27	11	13
Antibiotics							
Sulfonamides							
Sulfamerazine	5	< 10** (not detected)	< 5 (not detected)	< 5 (not detected)	< 10** (not detected)	< 5 (not detected)	< 10** (not detected)
Sulfamethoxazole	5	< 10** (not detected)	< 5 *	< 5 (not detected)	< 10** (not detected)	< 5 (not detected)	< 10** (not detected)
Sulfachloropyridazine	5	< 10** (not detected)	< 5 (not detected)	< 5 (not detected)	< 10** (not detected)	< 5 (not detected)	< 10 * ; **
Diaminopyrimidine							
Trimethoprim	10	90	59	< 10 *	< 20 * ; **	< 10 *	< 20 * ; **
* This compound was detected							
** Quantification limite is higher than "normal" because lower sample volume was used to the analysis.							
¹ Results made subject: absolute recoveries, calculated by comparing the concentrations of target compounds in spiked and unspiked samples, were proved to be 33 %.							
² Results made subject: absolute recoveries, calculated by comparing the concentrations of target compounds in spiked and unspiked samples, were proved to be 147 %.							
³ Absolute recovery was not satisfactory							
⁴ Results made subject: absolute recoveries, calculated by comparing the concentrations of target compounds in spiked and unspiked samples, were proved to be 33 %.							
⁵ Results made subject: absolute recoveries, calculated by comparing the concentrations of target compounds in spiked and unspiked samples, were proved to be 46 %.							
⁶ Results made subject: absolute recoveries, calculated by comparing the concentrations of target compounds in spiked and unspiked samples, were proved to be 144 %.							
⁷ Results made subject: absolute recoveries, calculated by comparing the concentrations of target compounds in spiked and unspiked samples, were proved to be 215 %.							
⁸ Results made subject: absolute recoveries, calculated by comparing the concentrations of target compounds in spiked and unspiked samples, were proved to be 50 %.							
⁹ Results made subject: absolute recoveries, calculated by comparing the concentrations of target compounds in spiked and unspiked samples, were proved to be 35 %.							
¹⁰ Results made subject: absolute recoveries, calculated by comparing the concentrations of target compounds in spiked and unspiked samples, were proved to be 156 %.							
¹¹ Results made subject: absolute recoveries, calculated by comparing the concentrations of target compounds in spiked and unspiked samples, were proved to be 47 %.							
Note: The limits of quantification were multiplied by 2 for the samples influent R1, R2 and R4 because we used 2 times lower sample than usually. Dried and crushed sludge was too low.							

CODIGREEN : monitoring of pharmaceutical substances in sludges from Braunschweig reactor - full-scale trials

		Berlin		
		1754 (Braunschweig 1)	1755 (Braunschweig 2)	1756 (Braunschweig 3)
	DM (g/L)	31,5	29	29
	oDM (g/L)	21	20,1	20,2
Concentrations en ng/g	Limit of quantification			
Pharmaceutical Compound				
Analgesic / Anti-inflammatory				
Paracetamol	5	13	< 5	< 5
Diclofenac	5	237	106	214 ¹
Phenazone	5	20	16	27
Antidepressant				
Fluoxetine	10	51 ²	< 10	44 ³
Anticonvulsant				
Carbamazepine	5	233	111	239 ⁴
Primidone	5	8	< 5	< 5
Antilipidemic				
Bezafibrate	5	18	< 5	10
Gemfibrozil	5	8	6	8
Betablockers				
Metoprolol	5	176	76	155 ⁵
Propranolol	5	22	8	17
Antibiotics				
Sulfonamides				
Sulfamerazine	5	< 5	< 5	< 5
Sulfamethoxazole	5	< 5	< 5	< 5
Sulfachloropyridazine	5	< 5	< 5	< 5
Diaminopyrimidine				
Trimethoprim	10	< 10	< 10	< 10
Macrolides				
Somme Erythromycine / Erythromycine-H2O	5	6	< 5	< 5

¹ Results made subject: absolute recoveries, calculated by comparing the concentrations of target compounds in spiked and unspiked samples, were proved to be 182%

² Results made subject: absolute recoveries, calculated by comparing the concentrations of target compounds in spiked and unspiked samples, were proved to be 26%

³ Results made subject: absolute recoveries, calculated by comparing the concentrations of target compounds in spiked and unspiked samples, were proved to be 34%

⁴ Results made subject: absolute recoveries, calculated by comparing the concentrations of target compounds in spiked and unspiked samples, were proved to be 228%

⁵ Results made subject: absolute recoveries, calculated by comparing the concentrations of target compounds in spiked and unspiked samples, were proved to be 156%

7.5 References

- EU-WRRL (2000): EU-Wasserrahmenrichtlinie (EU Water framework directive). <http://www.bmu.de/binnengewasser/gewaesserschutzpolitik/europa/doc/3063.php>
- Kopp, J. (2009): Wasseranteile in Klärschlammuspensionen – Messmethode und Praxisrelevanz; Veröffentlichung des Institutes für Siedlungswasserwirtschaft der TU Braunschweig, Heft 66.
- KTBL (2005): Kuratorium für Technik und Bauwesen in der Landwirtschaft e.V. (Hrsg.): Gasausbeuten in landwirtschaftlichen Biogasanlagen; Darmstadt 2005
- Sewage Sludge Ordinance, 2010: 2. Arbeitsentwurf zur Novelle der AbfKlärV; Stand Sept. 2010; <http://www.bmu.de/abfallwirtschaft/downloads/doc/46373.php>
- Trenkle (1998): ASE – Möglichkeiten eines neuen Verfahrens zur Extraktion von organischen Schadstoffen aus Festsubstanzen. VDLUFA-Kongress 1998, Gießen;

verfügbar online unter [http://www.landwirtschaft-mlr.baden-wuerttemberg.de/servlet/PB//show/](http://www.landwirtschaft-mlr.baden-wuerttemberg.de/servlet/PB//show/1073517_11/ltz_ASE%20Verfahrensm%C3%B6gl.%20zur%20Extraktion%20org.%20Schadst.%20aus%20Festsubstanzen.pdf)

[1073517_11/ltz_ASE%20Verfahrensm%C3%B6gl.%20zur%20Extraktion%20org.%20Schadst.%20aus%20Festsubstanzen.pdf](http://www.landwirtschaft-mlr.baden-wuerttemberg.de/servlet/PB//show/1073517_11/ltz_ASE%20Verfahrensm%C3%B6gl.%20zur%20Extraktion%20org.%20Schadst.%20aus%20Festsubstanzen.pdf)

- Wittenberg, M. 2003. Stoffstromanalyse und Bewertung von Umweltschutzmaßnahmen am Beispiel der Abwasserwirtschaft eines Automobilwerkes; Veröffentlichung des Institutes für Siedlungswasserwirtschaft der TU Braunschweig, Heft 71.