

Final Report of project number 10032582

**“Investigation of pre-ozonation on the
performance of membrane filtration
(Oxeram 1 – D 4.2)”**

Principal: Berliner Wasserbetriebe (BWB)



Anstalt des öffentlichen Rechts
Neue Jüdenstraße 1
10179 Berlin

Supported by: Kompetenzzentrum
Wasser Berlin gGmbH
Cicerostr. 24
10709 Berlin

Duration: January 2009 – Dezember 2009

Project Management: Prof. Dr.-Ing. Martin Jekel
Accomplishment: Dipl.-Ing. Cornelia Genz
Technische Universität Berlin
Institut für Technischen Umweltschutz
Fachgebiet Wasserreinhaltung
Fasanenstraße 1A, D-10623 Berlin
wrh@tu-berlin.de

Berlin, April 2010

Acknowledgements

The project team appreciates the sponsoring of the Oxeram project by BWB. We thank every person involved in the project for their help by solving technical problems and for input in discussions.

Thank you!

Abstract

Low-pressure membrane filtration of secondary effluents allows disinfection and, combined with chemical coagulation, advanced phosphorus removal. However, the loss of filtration performance due to membrane fouling is still a fundamental problem and has a strong impact on the costs of the process. Biopolymers as well as colloids in the range of 50 to 350 nm were identified as main foulants during ultrafiltration (UF).

In this project the impact of a pre-treatment by ozonation (2-10 mg O₃/L) and subsequent coagulation (FeCl₃: 2-6 mg Fe³⁺/L) on the performance of a polymer UF membrane was studied. No free dissolved ozone was in contact with the membrane. Lab tests were performed using Amicon test cells in dead-end mode fed with 500 mL secondary effluent of the WWTP Ruhleben (Berlin) and the flux decline during filtration was measured. The effect of the two pre-treatment steps on the character of DOC, especially the biopolymer fraction, was investigated using size exclusion chromatography.

The pre-treatment enables phosphorus removal of 75 up to 95 % with permeate concentrations of 30 to 50 µg P/L. In filtration tests pre-ozonation without flocculation leads to a less distinct flux decline (1-7 %). Coagulation without pre-ozonation increases the flux by 5 to 14 % compared to filtration of effluent without pre-treatment. The combination of both pre-treatment steps improves the filtration performance up to 30 % and reduces the filtration time for 500 mL by 50 %.

Different mechanisms are considered as reasons for the improved performance. It is known that coagulation partially removes the fouling-active biopolymers and humic substances. The pre-treatment with ozone, even at low dosages (2 mg/L), leads to a significant decrease of UV₂₅₄ absorbance, pointing on a shift to more polar molecules. Higher ozone dosages (> 6 mg/L) additionally induce disintegration of biopolymers and a shift to smaller organic compounds.

The interaction between ozonation and coagulation leads to a partial complexation of iron in solution. As a consequence, less iron is provided for the coagulation process. As the percentage of complexation of iron decreases with increasing coagulant dosage, the synergetic effect of pre-ozonation and coagulation on the filtration performance increases with increasing iron dosage.

These results suggest that combining pre-ozonation and coagulation can be a promising pre-treatment process to reduce the fouling of organic membranes, without the necessity of applying free dissolved ozone on the membrane surface.

Zusammenfassung

Die Filtration von Klärwerksabläufen mit Niederdruckmembranen bietet in Kombination mit einer Flockungsstufe eine wirkungsvolle Möglichkeit für das Erreichen niedriger Phosphorkonzentrationen und einer zusätzlichen Entfernung von Pathogenen. Das Hauptproblem beim Betrieb von Niederdruckmembranen stellt nach wie vor der durch Fouling auftretende Verlust der Filtrationsleistung dar. Als Folge des Foulings müssen die Membranen regelmäßig physikalisch bzw. chemisch gereinigt werden, was zu einer Verringerung ihrer Standzeit und somit zu höheren Kosten führt. Biopolymere und Kolloide in der Größenordnung 50-350 nm wurden als Hauptverursacher des Foulings während der Ultrafiltration (UF) identifiziert.

Im Rahmen dieses Projektes wurde untersucht, ob durch eine Ozonierung (2-10 mg O₃/L) vor der Flockungsstufe (FeCl₃: 2-6 mg Fe³⁺/L) das Fouling der nachgeschalteten Membran reduziert und somit die Leistungsfähigkeit der Membranfiltration verbessert werden kann. Es wurden Labortests mit Amicon-Zellen im Dead-End-Modus durchgeführt, wobei die Membran zu keiner Zeit mit freiem Ozon in Kontakt stand. 500 ml Klarlauf der Kläranlage Ruhleben (Berlin) wurden filtriert und die Fluxabnahme kontinuierlich gemessen. Die Auswirkungen der beiden Vorbehandlungen auf den Charakter des DOC, im speziellen auf die Biopolymerfraktion, wurden mit Hilfe der Größenausschlusschromatographie untersucht.

Die Behandlung des Klarlaufes mit einer Kombination aus Flockung und UF-Membran ermöglichte, unabhängig von der Ozonierung, Phosphorentfernungsraten von 75 bis 95 %, korrespondierend mit Phosphorkonzentrationen von 30 bis 50 µg P/L im Permeat der UF-Membran. Die Ozonierung führte zu einem geringen Anstieg des Fluxes zwischen 1 und 7 %. Ein weitaus größerer Effekt von 5 bis 14 % Fluxzunahme, verglichen mit der Filtration des Klarlaufes ohne weitere Vorbehandlungen, wurde durch die Flockung erzielt. Die Kombination aus Ozonierung und Flockung verbesserte die Filtrationsleistung der Membran um bis zu 30 % und reduzierte die Filtrationszeit für 500 ml Klarlauf um 50 %.

Für die verbesserte Filtrationsleistung kommen verschiedene Ursachen in Betracht. Es ist bekannt, dass Flockung die fouling-aktiven Biopolymere und Huminstoffe teilweise entfernt. Die Vorbehandlung mit Ozon führt schon bei niedrigen Ozondosen (2 mg/L) zu einer signifikanten Abnahme des SAK₂₅₄, was auf eine Verschiebung hin zu polareren Molekülen hindeutet. Höhere Ozondosen (> 6 mg/L) induzieren zusätzlich eine Zerkleinerung der Biopolymere und eine Veränderung hin zu kleineren organischen Bestandteilen.

Das Zusammenwirken von Ozonierung und Flockung führt zu einer partiellen Komplexierung des Eisens in Lösung, weshalb weniger Eisen für den Flockungsprozess zur Verfügung steht. Da der prozentuale Anteil an komplexiertem Eisen mit steigender Flockungsmitteldosis abnimmt, vergrößert sich der synergetische Effekt von Ozonierung und Flockung auf die Filtrationsleistung mit steigender Eisendosis.

Die bisher im Rahmen des Projekts durchgeführten Versuche zeigen, dass die Kombination aus Ozonierung und Flockung eine viel versprechende Vorbehandlung vor der Ultrafiltration darstellt, um Fouling von organischen Membranen zu reduzieren ohne die Notwendigkeit, die Membranoberfläche mit freiem Ozon in Kontakt zu bringen.

Contents

| | | |
|--------|--|----|
| 1 | Introduction | 1 |
| 2 | Material and Methods..... | 3 |
| 2.1.1 | Jar tests | 3 |
| 2.1.2 | Ozonation unit | 4 |
| 2.1.3 | Filtration tests..... | 6 |
| 2.1.4 | Backwash trials | 8 |
| 2.1.5 | Microfiltration (MF) tests..... | 9 |
| 2.2 | Analytics..... | 9 |
| 2.2.1 | Turbidity < 1 µm | 10 |
| 3 | Results | 12 |
| 3.1 | Filtration Tests..... | 12 |
| 3.1.1 | Flux decline and filtration time | 12 |
| 3.1.2 | Total Soluble Phosphorus (P _{T,f})..... | 15 |
| 3.1.3 | Liquid Chromatography – Organic Carbon Detection (LC-OCD) | 17 |
| 3.1.4 | Dissolved Organic Carbon (DOC) | 20 |
| 3.1.5 | Residual Iron | 21 |
| 3.1.6 | Turbidity < 1 µm | 22 |
| 3.1.7 | Temperature, pH and electric conductivity | 23 |
| 3.1.8 | Ultraviolet Absorbance at 254 nm (UVA 254) | 24 |
| 3.1.9 | Absorbance at 436 nm (Colour 436) | 25 |
| 3.1.10 | Dissolved Chemical Oxygen Demand (COD _f) | 26 |
| 3.2 | Microfiltration (MF) tests..... | 28 |
| 3.3 | Backwash trials | 29 |
| 4 | Conclusion and Perspective | 34 |
| 5 | References | 36 |
| 6 | Annex | 37 |
| 6.1 | Calculation of the pressure needed for MF filtration tests | 37 |
| 6.2 | Diagrams | 37 |
| 6.2.1 | Ozonation | 37 |
| 6.2.2 | Flux decline | 42 |
| 6.2.3 | Total Soluble Phosphorus (P _{T,f})..... | 44 |
| 6.2.4 | LC-OCD | 47 |
| 6.2.5 | DOC | 51 |
| 6.2.6 | Residual Iron | 52 |
| 6.2.7 | Turbidity < 1 µm | 55 |
| 6.2.8 | UVA 254 | 56 |
| 6.2.9 | Colour 436..... | 57 |
| 6.2.10 | COD _f | 58 |
| 6.3 | Data | 58 |
| 6.3.1 | P _{T,f} | 58 |
| 6.3.2 | PO ₄ -P | 62 |
| 6.3.3 | DOC | 66 |
| 6.3.4 | Residual Iron | 70 |
| 6.3.5 | Turbidity < 1 µm | 76 |
| 6.3.6 | Temperature, pH and electric conductivity | 79 |
| 6.3.7 | UVA 254 | 83 |
| 6.3.8 | Colour 436..... | 87 |
| 6.3.9 | COD _f | 92 |

List of Figures

| | |
|--|----|
| Figure 1: Ozonation unit | 5 |
| Figure 2: Ozonation of Ruhleben secondary effluent for filtration tests (2009-06-02) | 6 |
| Figure 3: Schematic set-up for trials with the Amicon test cell (adapted from Zheng (2010)) . | 7 |
| Figure 4: Set-up for trials with the Amicon test cell | 8 |
| Figure 5: Steel filter used for the 1 μm filtration | 11 |
| Figure 6: Flux decline curves for different coagulant dosages of 0-6 mg Fe^{3+}/L with and without pre-ozonation (Figure 6a: 10 mg O_3/L , Figure 6b: 2 mg O_3/L) | 13 |
| Figure 7: Flux decline curves for different ozone dosages of 0-10 mg O_3/L and a constant FeCl_3 addition of 2 mg Fe^{3+}/L (Figure 7a) and 6 mg Fe^{3+}/L (Figure 7b) | 14 |
| Figure 8: Filtration times for different ozone dosages of 0-10 mg O_3/L and a constant coagulant addition of 2 mg Fe^{3+}/L (Figure 8a) and 6 mg Fe^{3+}/L (Figure 8b) | 14 |
| Figure 9: Phosphorus concentrations of Ruhleben effluent after 0.45 μm filtration and after UF for different Fe^{3+} -concentrations of 0 - 6 mg Fe^{3+}/L with 2 mg O_3/L (Figure 9b) and 10 mg O_3/L (Figure 9a) pre-ozonation | 16 |
| Figure 10: Phosphorus concentrations of Ruhleben effluent after 0.45 μm filtration and after UF for Fe^{3+} -concentrations of 2 mg Fe^{3+}/L (Figure 10 a) and 6 mg Fe^{3+}/L (Figure 10b) and ozone dosages of 0-10 mg O_3/L | 16 |
| Figure 11: $P_{T,f}$ concentration in the permeate against $P_{T,f}$ concentrations in the effluent for different coagulant concentrations | 17 |
| Figure 12: LC-OCD diagram of Ruhleben secondary treated effluent with ozone dosages of 0-10 mg O_3/L and a fixed coagulant concentration of 2 mg Fe^{3+}/L | 17 |
| Figure 13: Biopolymer peak of Ruhleben secondary treated effluent analysed by LC-OCD with coagulant concentrations from 0 - 6 mg Fe^{3+}/L and an ozone dosage of 10 mg O_3/L before (Figure 13a) and after UF (Figure 13b) | 18 |
| Figure 14: Biopolymer peak of Ruhleben secondary treated effluent analysed by LC-OCD with coagulant concentrations from 0 - 6 mg Fe^{3+}/L and an ozone dosage of 2 mg O_3/L before (Figure 14a) and after UF (Figure 14b) | 18 |
| Figure 15: Biopolymer peak of Ruhleben secondary treated effluent analysed by LC-OCD with a coagulant concentration of 2 mg Fe^{3+}/L and different ozone dosages (0-10 mg O_3/L) before (Figure 15a) and after UF (Figure 15b) | 19 |
| Figure 16: Biopolymer peak of Ruhleben secondary treated effluent analysed by LC-OCD with a coagulant concentration of 6 mg Fe^{3+}/L and different ozone dosages (0-10 mg O_3/L) before (Figure 16a) and after UF (Figure 16b) | 19 |
| Figure 17: Relative DOC concentration for different coagulant dosages of 0-6 mg Fe^{3+}/L with and without pre-ozonation (Figure 17a: 2 mg O_3/L , DOC_0 : 9.8 mg/L; Figure 17b: 10 mg O_3/L , DOC_0 : 10.1 mg/L) | 20 |
| Figure 18: Relative DOC concentration for different ozone dosages of 0-10 mg O_3/L and a constant FeCl_3 addition of 2 mg Fe^{3+}/L (Figure 18a, DOC_0 : 9.7 mg/L) and 6 mg Fe^{3+}/L (Figure 18b, DOC_0 : 10.9 mg/L) | 21 |
| Figure 19: Residual iron concentrations of Ruhleben effluent after 0.45 μm filtration and after UF for different Fe^{3+} -concentrations of 0 - 6 mg Fe^{3+}/L with pre-ozonation dosages of 2 mg O_3/L (UF II-A) and 10 mg O_3/L (UF I-B) | 21 |
| Figure 20: Residual iron concentrations of Ruhleben effluent after 0.45 μm filtration and after UF for Fe^{3+} -concentrations of 2 mg Fe^{3+}/L (UF III-A) and 6 mg Fe^{3+}/L (UF IV-A) and ozone dosages of 0-10 mg O_3/L | 22 |
| Figure 21: Turbidity < 1 μm for samples treated with 10 mg O_3/L and different subsequent coagulant dosages of 0-6 mg Fe^{3+}/L | 23 |
| Figure 22: Turbidity < 1 μm for samples treated with 2 mg O_3/L and different subsequent coagulant dosages of 0-6 mg Fe^{3+}/L | 23 |

| | |
|--|----|
| Figure 23: Relative UVA 254 for different coagulant dosages of 0-6 mg Fe ³⁺ /L with and without pre-ozonation (Figure 23a: 2 mg O ₃ /L, UVA 254 ₀ : 26.70/m; Figure 23b: 10 mg O ₃ /L, UVA 254 ₀ : 27.08/m) | 24 |
| Figure 24: Relative UVA 254 for different ozone dosages of 0-10 mg O ₃ /L and a constant FeCl ₃ addition of 2 mg Fe ³⁺ /L (Figure 24a, UVA 254 ₀ : 27.00/m) and 6 mg Fe ³⁺ /L (Figure 24b, UVA 254 ₀ : 27.04/m), respectively | 25 |
| Figure 25: Relative Colour 436 for different coagulant dosages of 0-6 mg Fe ³⁺ /L with and without pre-ozonation (Figure 25a: 2 mg O ₃ /L, Colour 436 ₀ : 1.43/m; Figure 25b: 10 mg O ₃ /L, Colour 436 ₀ : 1.68/m)..... | 25 |
| Figure 26: Relative Colour 436 for different ozone dosages of 0-10 mg O ₃ /L and a constant FeCl ₃ addition of 2 mg Fe ³⁺ /L (Figure 26a, Colour 436 ₀ : 1.72/m) and 6 mg Fe ³⁺ /L (Figure 26b, Colour 436 ₀ : 1.65/m), respectively | 26 |
| Figure 27: Relative COD _f for different coagulant dosages of 0-6 mg Fe ³⁺ /L with and without pre-ozonation (Figure 27a: 2 mg O ₃ /L, COD _{f,0} : 30.2 mg/L ;Figure 27b: 10 mg O ₃ /L, COD _{f,0} : 30.1 mg/L) | 26 |
| Figure 28: Relative COD _f for different ozone dosages of 0-10 mg O ₃ /L and a constant FeCl ₃ addition of 2 mg Fe ³⁺ /L (Figure 28a, COD _{f,0} : 27.8 mg/L) and 6 mg Fe ³⁺ /L (Figure 28b, COD _{f,0} : 29.1 mg/L), respectively | 27 |
| Figure 29: Flux decline curves for different coagulant concentrations of 0 and 4 mg Fe ³⁺ /L with an applied pressure of 0.2 bar | 28 |
| Figure 30: Flux decline curves for different ozone dosages of 0 and 6 mg O ₃ /L and coagulant concentrations of 0 and 4 mg Fe ³⁺ /L with an applied pressure of 0.5 bar | 28 |
| Figure 31: Flux decline curves for different coagulant concentrations of 0 and 4 mg Fe ³⁺ /L with an applied pressure of 0.7 bar | 29 |
| Figure 32: Flux decline curves of BW experiments and corresponding filtration times comparing untreated Ruhleben effluent and Ruhleben effluent pre-treated with 6 mg O ₃ /L and 4 mg Fe ³⁺ /L | 30 |
| Figure 33: Flux decline curves of BW experiments and corresponding filtration times comparing coagulated Ruhleben effluent (4 mg Fe ³⁺ /L) and Ruhleben effluent pre-treated with 6 mg O ₃ /L and 4 mg Fe ³⁺ /L | 32 |
| Figure 34: Flux decline curves of BW experiments comparing coagulated Ruhleben effluent and Ruhleben effluent pre-treated with 2, 6 or 10 mg O ₃ /L and 4 mg Fe ³⁺ /L | 33 |

List of Tables

| | |
|--|----|
| Table 1: Fixed and variable parameters | 3 |
| Table 2: Conditions of the coagulation in jar tests with and without pre-ozonation | 4 |
| Table 3: Trial series of the backwash experiments | 9 |
| Table 4: Trial series of the MF tests..... | 9 |
| Table 5: Examined parameters..... | 10 |
| Table 6: Overview of results of UF trials – Ozonation of Ruhleben secondary treated effluent with different combinations of Fe ³⁺ -concentrations (0 - 6 mg Fe/L) and ozone dosages (0-10 mg O ₃ /L) – overview of results of UF trials..... | 37 |
| Table 7: Overview of results of UF trials – Flux decline curves of Ruhleben secondary treated effluent with different combinations of Fe ³⁺ -concentrations (0 - 6 mg Fe/L) and ozone dosages (0-10 mg O ₃ /L) | 42 |
| Table 8: Overview of results of BW trials – Flux decline curves of untreated Ruhleben secondary effluent and Ruhleben secondary effluent with 4 mg Fe ³⁺ /L and different ozone dosages (0-10 mg O ₃ /L)..... | 44 |
| Table 9: Overview of results of UF trials – P _{T,f} of Ruhleben secondary treated effluent with different combinations of Fe ³⁺ -concentrations (0 - 6 mg Fe/L) and ozone dosages (0-10 mg O ₃ /L)..... | 44 |
| Table 10: Overview of results of BW trials – P _{T,f} of untreated Ruhleben secondary effluent and Ruhleben secondary effluent with 4 mg Fe ³⁺ /L and different ozone dosages (0-10 mg O ₃ /L)..... | 46 |
| Table 11: P _{T,f} results of MF trials..... | 47 |
| Table 12: Overview of results of UF trials – BP peaks of LC-OCD diagrams of Ruhleben secondary treated effluent with different combinations of Fe ³⁺ -concentrations (0 - 6 mg Fe/L) and ozone dosages (0-10 mg O ₃ /L) | 47 |
| Table 13: Overview of results of BW trials – BP peaks of LC-OCD diagrams of untreated Ruhleben secondary effluent and Ruhleben secondary effluent with 4 mg Fe ³⁺ /L and different ozone dosages (0-10 mg O ₃ /L)..... | 50 |
| Table 14: BP peaks of LC-OCD diagrams - results of MF trials..... | 51 |
| Table 15: Overview of results of BW trials – DOC of untreated Ruhleben secondary effluent and Ruhleben secondary effluent with 4 mg Fe ³⁺ /L and different ozone dosages (0-10 mg O ₃ /L)..... | 51 |
| Table 16: Overview of results of UF trials – Residual iron of Ruhleben secondary treated effluent with different combinations of Fe ³⁺ -concentrations (0 - 6 mg Fe/L) and ozone dosages (0-10 mg O ₃ /L) | 52 |
| Table 17: Overview of results of BW trials – Residual iron of untreated Ruhleben secondary effluent and Ruhleben secondary effluent with 4 mg Fe ³⁺ /L and different ozone dosages (0-10 mg O ₃ /L) | 54 |
| Table 18: Overview of results of UF trials – Turbidity < 1 µm of Ruhleben secondary treated effluent with different combinations of Fe ³⁺ -concentrations (0 - 6 mg Fe/L) and ozone dosages (0-10 mg O ₃ /L) | 55 |
| Table 19: Overview of results of BW trials – UVA 254 of untreated Ruhleben secondary effluent and Ruhleben secondary effluent with 4 mg Fe ³⁺ /L and different ozone dosages (0-10 mg O ₃ /L) | 56 |
| Table 20: Overview of results of BW trials – Colour 436 of untreated Ruhleben secondary effluent and Ruhleben secondary effluent with 4 mg Fe ³⁺ /L and different ozone dosages (0-10 mg O ₃ /L) | 57 |

| | |
|--|----|
| Table 21: Overview of results of BW trials – COD _f of untreated Ruhleben secondary effluent and Ruhleben secondary effluent with 4 mg Fe ³⁺ /L and different ozone dosages (0-10 mg O ₃ /L)..... | 58 |
| Table 22: P _{T,f} of Ruhleben secondary treated effluent with different combinations of Fe ³⁺ -concentrations (0 - 6 mg Fe/L) and ozone dosages (0-10 mg O ₃ /L) – results of UF trials..... | 58 |
| Table 23: P _{T,f} of untreated Ruhleben secondary effluent and Ruhleben secondary effluent with 4 mg Fe ³⁺ /L and different ozone dosages (0-10 mg O ₃ /L) – results of BW trials | 60 |
| Table 24: P _{T,f} results of MF trials..... | 62 |
| Table 25: PO ₄ -P of Ruhleben secondary treated effluent with different combinations of Fe ³⁺ -concentrations (0 - 6 mg Fe/L) and ozone dosages (0-10 mg O ₃ /L) – results of UF trials..... | 62 |
| Table 26: PO ₄ -P of untreated Ruhleben secondary effluent and Ruhleben secondary effluent with 4 mg Fe ³⁺ /L and different ozone dosages (0-10 mg O ₃ /L) – results of BW trials | 64 |
| Table 27: DOC of Ruhleben secondary treated effluent with different combinations of Fe ³⁺ -concentrations (0 - 6 mg Fe/L) and ozone dosages (0-10 mg O ₃ /L) – results of UF trials..... | 66 |
| Table 28: DOC of untreated Ruhleben secondary effluent and Ruhleben secondary effluent with 4 mg Fe ³⁺ /L and different ozone dosages (0-10 mg O ₃ /L) – results of BW trials | 68 |
| Table 29: Residual iron of Ruhleben secondary treated effluent with different combinations of Fe ³⁺ -concentrations (0 - 6 mg Fe/L) and ozone dosages (0-10 mg O ₃ /L) – results of UF trials..... | 70 |
| Table 30: Residual iron of untreated Ruhleben secondary effluent and Ruhleben secondary effluent with 4 mg Fe ³⁺ /L and different ozone dosages (0-10 mg O ₃ /L) – results of BW trials | 74 |
| Table 31: Turbidity < 1 µm of Ruhleben secondary treated effluent with different combinations of Fe ³⁺ -concentrations (0 - 6 mg Fe/L) and ozone dosages (0-10 mg O ₃ /L) – results of UF trials..... | 76 |
| Table 32: Temperature, pH and electric conductivity of Ruhleben secondary treated effluent with different combinations of Fe ³⁺ -concentrations (0 - 6 mg Fe/L) and ozone dosages (0-10 mg O ₃ /L) – results of UF trials..... | 79 |
| Table 33: Temperature, pH and electric conductivity of untreated Ruhleben secondary effluent and Ruhleben secondary effluent with 4 mg Fe ³⁺ /L and different ozone dosages (0-10 mg O ₃ /L) – results of BW trials..... | 80 |
| Table 34: Temperature, pH and electric conductivity results of MF trials | 83 |
| Table 35: UVA 254 of Ruhleben secondary treated effluent with different combinations of Fe ³⁺ -concentrations (0 - 6 mg Fe/L) and ozone dosages (0-10 mg O ₃ /L) – results of UF trials..... | 83 |
| Table 36: UVA 254 of untreated Ruhleben secondary effluent and Ruhleben secondary effluent with 4 mg Fe ³⁺ /L and different ozone dosages (0-10 mg O ₃ /L) – results of BW trials | 86 |
| Table 37: Colour 436 of Ruhleben secondary treated effluent with different combinations of Fe ³⁺ -concentrations (0 - 6 mg Fe/L) and ozone dosages (0-10 mg O ₃ /L) – results of UF trials..... | 87 |
| Table 38: Colour 436 of untreated Ruhleben secondary effluent and Ruhleben secondary effluent with 4 mg Fe ³⁺ /L and different ozone dosages (0-10 mg O ₃ /L) – results of BW trials | 90 |

| | |
|--|----|
| Table 39: COD _f of Ruhleben secondary treated effluent with different combinations of Fe ³⁺ - concentrations (0 - 6 mg Fe/L) and ozone dosages (0-10 mg O ₃ /L) – results of UF trials..... | 92 |
| Table 40: COD _f of untreated Ruhleben secondary effluent and Ruhleben secondary effluent with 4 mg Fe ³⁺ /L and different ozone dosages (0-10 mg O ₃ /L) – results of BW trials | 94 |

List of Abbreviations

| | |
|--------|--|
| BP | Biopolymer |
| BW | Backwash |
| LC-OCD | Liquid Chromatography - Organic Carbon Detection |
| J | measured flux |
| J_0 | pure water flux |
| MF | Microfiltration |
| MWCO | Molecular weight cut off |
| RPM | Rotations per minute |
| UF | Ultrafiltration |
| WWTP | Wastewater treatment plant |

1 Introduction

The European Water Framework Directive (EU-Wasserrahmenrichtlinie 2000) establishes several principles for water management with the goal to reach a “good ecological status” of all surface waters until 2015. Consequently, the Berlin regional wastewater disposal scheme (Senatsverwaltung für Stadtentwicklung (Ed.) 2001) aims at water quality class II for the local rivers (River Spree and River Havel), corresponding with a low eutrophic status.

In order to prevent eutrophication and growth of algae, the discharge of phosphorus from the Berlin waste water treatment plants into the surface waters of the region (Berlin/Brandenburg) has to be minimized. According to a previous study and following a verified mathematical correlation of total phosphorus and algae growth (expressed by chlorophyll-A concentration), the average tolerable phosphorus level to ensure surface water quality class II is 16-82 µg P/L. (Senatsverwaltung für Stadtentwicklung (Ed.) 2001)

As a consequence, the Berlin public utilities (Berliner Wasserbetriebe) consider to expand the treatment train of the wastewater treatment plant (WWTP) Ruhleben by a process consisting of (pre-)coagulation and subsequent membrane filtration process, a so-called “advanced treatment stage” (Gnirß 2008). This additional treatment shall reduce the medium annual phosphorus effluent concentration from 0.3 – 0.4 mg P/L down to a target concentration of 0.05 – 0.1 mg P/L, which is believed to guarantee the above mentioned water quality class II.

In general, low-pressure membrane filtration of secondary effluents allows disinfection and, combined with chemical coagulation, advanced phosphorus removal. However, the loss of filtration performance due to membrane fouling is still a fundamental problem and has a strong impact on the costs of the process.

Organic fouling of membranes by formation of a cake layer on the membrane surface, pore blocking or in-pore adsorption results in a reduction of the trans-membrane flux (operating with a constant trans-membrane pressure) or an increase of the trans-membrane pressure loss (operating with a constant trans-membrane flux) with increasing filtration time. As a consequence, membranes have to be periodically cleaned applying physical or chemical cleaning procedures, leading to a reduction of operation time.

Organic fouling is caused by particles and by larger dissolved organic substances. Zheng et al. (2009) and Te Poele (2006) found that biopolymers (BP) in the form of proteins and polysaccharides as well as colloids in the size of 10–450 nm are mainly responsible for the fouling of low-pressure membranes. With regard to dissolved organic substances (DOC), only 10 % of the DOC contained in Ruhleben effluent contributes to the fouling process (Laabs 2004). Using size exclusion chromatography (LC-OCD), these substances typically elute within the so-called “biopolymer peak”, consisting mainly of polysaccharides, organic colloids and proteins.

A promising approach to reduce organic fouling and to improve the membrane filtration performance is the application of ozone. The combination of coagulation and ozonation using relative low O₃ dosages (1 - 2 mg/L) can lead to the formation of larger, more stable flocs as a

result of the so-called “microflocculation effect” (Jekel 1998), hence having a positive effect on the membrane filtration performance. Beyond this microflocculation effect higher ozone dosages (10 - 12 mg O₃/L) lead to partial oxidation of organic substances and micropollutants (Bahr et al. 2007).

The present study investigates more precisely the question if a pre-treatment by ozonation would be suitable to improve the subsequent coagulation/membrane filtration process at the WWTP Ruhleben. Lab-scale tests were performed using Amicon test cells applying simultaneous monitoring of filtration performance by measuring trans-membrane flux and fouling potential by BP analysis. Furthermore, it is investigated which combination of the two processes ozonation/coagulation leads to optimal results, with the aim to find the optimal ratio of ozone dosage and coagulant concentration.

2 Material and Methods

In this project the impact of a pre-treatment by ozonation and subsequent coagulation on the performance of a polymeric ultrafiltration (UF) membrane was studied. Secondary effluent of the WWTP Ruhleben was treated with different combinations of coagulant concentration and ozone dosages. Ferric Chloride (FeCl_3) was used as coagulant. As shown in Table 1, two different trial series were conducted. Series 1 comprised experiments with a constant ozone dosage of 2 and 10 $\text{mg O}_3/\text{L}$, respectively, and a varying coagulant concentration (0-6 $\text{mg Fe}^{3+}/\text{L}$), whereas series 2 consisted of experiments with varying ozone dosage (0-10 $\text{mg O}_3/\text{L}$) and constant coagulant concentration of 2 and 6 $\text{mg Fe}^{3+}/\text{L}$, respectively. All trials were conducted in 2009.

Table 1: Fixed and variable parameters

| Name of experiment | Ozone dosage [mg/L] | Coagulant concentration [mg/L] | Date |
|--------------------|----------------------|--------------------------------|----------|
| UF I-A | 10 | 2, 6 | 02.06. * |
| UF I-B | | | 08.06. |
| UF I-C | | | 07.07. |
| UF II-A | 2 | 2, 6 | 15.06. |
| UF II-B | | | 30.06. |
| UF II-C | | | 14.07. |
| UF III-A | 0, 2, 4, 6, 8 und 10 | 2 | 21.07. |
| UF III-B | | | 28.07. |
| UF IV-A | 0, 2, 6 und 10 | 6 | 11.08. |
| UF IV-B | | | 08.09. |
| UF V-A | 0, 2, 6 und 10 | 4 | 15.09. |
| UF V-B | | | 22.09. |
| UF V-C | | | 17.11. |

* not all parameters measured

Additionally to these UF filtration tests, backwash (BW) experiments have been conducted (described in chapter 2.1.4) and filtration tests with an MF membrane (described in chapter 2.1.5).

2.1.1 Jar tests

To optimise the coagulation jar tests were performed according to „technical rule DVGW W 218 (1998)“ with secondary treated effluent from WWTP Ruhleben. FeCl_3 was used as coagulant with a concentration of 1-6 $\text{mg Fe}^{3+}/\text{L}$. Two types of jar tests were conducted:

- Coagulation
- Pre-ozonation with Coagulation

During the experiments there was no variation of pH due to the high buffer capacity of the secondary treated effluent and all experiments were conducted at room temperature. The ozonated water was prepared using an ozone generator from WEDECO. The preparation was performed in a separate container by continuously bubbling ozone gas into a small volume of

distilled-deionized water. Aliquots of this ozone stock solution were drawn and injected into the jar. The volume of each aliquot to deliver a predetermined ozone dosage of 1-2 mg O₃/L to the test water in the jar had been calculated before. The addition of ozonated water was followed by a stirring period of 1.5 minutes at 100 rpm and the subsequent mixing with the coagulant FeCl₃. Table 2 depicts the test conditions of the coagulation with 1 - 6 mg Fe³⁺/L in jar tests with and without pre-ozonation.

Table 2: Conditions of the coagulation in jar tests with and without pre-ozonation

| Performance | Pre-ozonation and Coagulation conditions | |
|-------------|--|---|
| Coagulation | Pre-ozonation and coagulation | Ozone addition: 1-2 mg O ₃ /L |
| | | Stirring: 1.5 minutes at 100 rpm |
| | | Coagulant addition: 1-6 mg Fe ³⁺ /L |
| | | Stirring: 30 seconds at 400 rpm 5 minutes at 60 rpm |

2.1.2 Ozonation unit

Pre-ozonation and coagulation trials should also be conducted with higher ozone dosages of 10 mg O₃/L. Obtaining these ozone dosages with the help of a stock solution as described in chapter 2.1.1 would have led to an intense dilution of the sample due to the relatively huge amount of stock solution needed. Therefore preparation of samples with high ozone dosages was conducted with an ozonation unit existing since March 2009 at the TU Berlin.

As this ozonation unit is either able to produce low ozone dosages of 2 mg O₃/L or high ozone dosages of 10 mg O₃/L in Ruhleben secondary effluent and in order to achieve a good comparability of the experiments, from the end of April all ozonation steps were performed at the ozonation unit. Therefore ozonation for Amicon test cell experiments was only conducted using the ozonation unit, which is shown in Figure 1.



Figure 1: Ozonation unit

The ozonation unit produces gaseous ozone from pure oxygen using an ozone generator from WEDECO (type Modular 8HC, ITT WEDECO GmbH, Germany). The gaseous ozone provided by the ozone generator was directly introduced into the sample in a 4-L-semi-batch stirred tank reactor. An ozone mass balance according to Equation 1 was set up automatically by a computer as in-gas and off-gas ozone concentration, dissolved ozone and gas flow rate were measured continuously.

$$O_{3,consumed} = \int (O_{3,in-gas} - O_{3,off-gas}) dt - O_{3,dissolved} \quad \text{Equation 1}$$

Additionally, analysis of the pH was carried out in a by-pass. Figure 2 shows an example from ozonation for filtration tests with a target ozone dosage of 10 mg O₃/L. For completion of the mass balance, the off-gas ozone was completely stripped with pure oxygen. Target ozone dosage was 2 mg O₃/L and 10 mg O₃/L, respectively, corresponding to 0.2 and 0.9 mg O₃/mg DOC. These specific ozone dosages are in the range of those used from Bahr et al. (2007), who showed a decrease in BP concentration with increasing specific ozone consumptions from 0.2 - 1.4 mg O₃/mg DOC. As a variance of factors influence the consumption of ozone in secondary effluent, aspired ozone dosages were slightly variable as an exact adjustment was not possible.

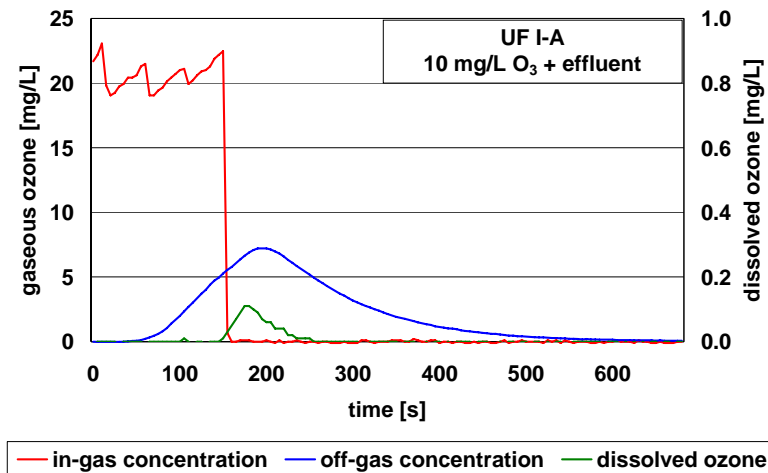

Figure 2: Ozonation of Ruhleben secondary effluent for filtration tests (2009-06-02)

Depending on water quality and the target ozone dosage, ozone input lasted about 5 - 15 minutes and was carried out at 360 rotations per minute (rpm). Free dissolved ozone was only detectable in small amounts up to 0.2 mg O₃/L during trials with pre-ozonation dosages of 10 mg O₃/L and high in-gas ozone concentrations of approximately 20 mg O₃/L. By application of lower in-gas ozone concentrations of approximately 12 mg O₃/L no free dissolved ozone was detectable. Coagulation with FeCl₃ was conducted according to „technical rule DVGW W 218“ with secondary treated effluent from WWTP Ruhleben except the volume of the beaker, which was 4 L instead of 2 L. Direct addition of FeCl₃ into the 4-L-semi-batch stirred tank reactor was followed by a stirring period of 30 seconds at 360 rpm with subsequent stirring at 60 rpm for 5 minutes.

2.1.3 Filtration tests

Amicon dead-end test cells (stirred ultrafiltration cell, model 8200, Millipore Corporation, USA) with a volume of 200 ml and an effective membrane filtration area of 28.7 cm² were used to determine the fouling potential as flux decline over time. The attached feed reservoir permits filtration of samples up to 4 L. The sample is filled into the water reservoir and pressurized using nitrogen gas. Slowly stirring prevents the flocs from settling. Membrane flux is measured by collecting permeate in a beaker on an electric balance which is connected with a computer. Thus change in weight is measured over time. Flux decline results from the stirred cell experiments are shown as normalized flux J/J_0 over permeate volume. J_0 is the pure water flux and J the permeate flux. This presentation allows for a better comparison of different flux decline curves, i.e. all curves start at $J/J_0=1$. A schematic set-up of the Amicon test cell trials is illustrated in Figure 3.

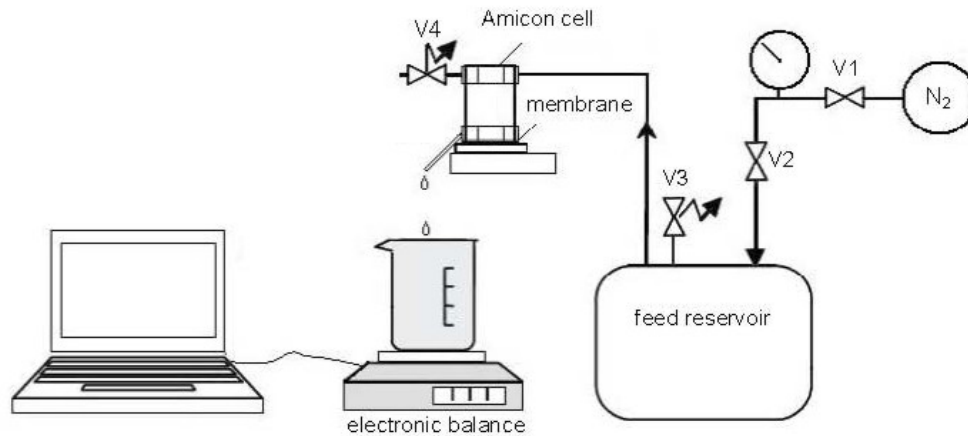

Figure 3: Schematic set-up for trials with the Amicon test cell (adapted from Zheng (2010))

Amicon test cells were fed in dead-end mode with 500 ml sample. The membrane is fixed at the bottom of the Amicon test cell. For all trials a NADIR[®] UP150 ultrafiltration membrane (MICRODYN-NADIR GmbH, Germany) was used. This UF-membrane is made of permanent hydrophilized polyethersulphone (PES) and has a molecular weight cut off (MWCO) of 150 kDa corresponding to a pore size of 26 nm. Each filtration test was performed using a new membrane. Prior to the experiments, each membrane was washed by a leaching procedure. Membranes were soaked in pure water for at least 24 h and subsequently filtrated with 2 L pure water in order to remove wetting agents and production residues and to reach a stable permeate flux under 1 bar. 100 ml of pure water are filtered through the membrane immediately before the experiment for determining the pure water flux J_0 of the membrane. As during the experiments, flux is recorded with the help of a balance that is connected with a computer. For each filtration trial only membranes within a 20 % variation of pure water flux were applied. Pre-treated Ruhleben secondary effluent was filled into the feed reservoir and a constant pressure of 1 bar was applied. All experiments are run at room temperature (approximately 22°C) and constant pressure (1 bar). Figure 4 shows the Amicon test cell set-up in the laboratory at the TU Berlin.

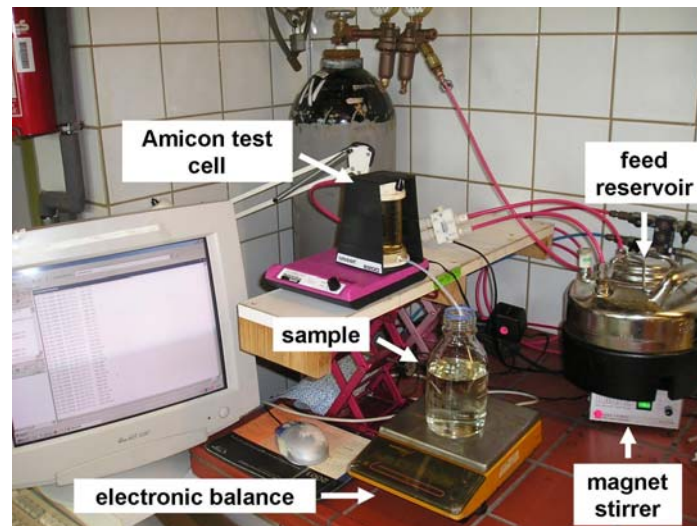

Figure 4: Set-up for trials with the Amicon test cell

2.1.4 Backwash trials

UF backwash (BW) experiments were performed to study fouling of differently treated Ruhleben effluent. Coagulated samples were again compared to samples treated with a combination of pre-ozonation and subsequent coagulation. Three different trial series of BW experiments were conducted and are displayed in Table 3. The concentrations used were 0 and 4 mg Fe^{3+} /L and pre-ozonation was either conducted with 0, 2 or 6 mg O_3 /L. The preparation of the membrane was performed as described by Jermann et al. (2008) and Zheng et al. (2009). Deviant from these procedures pressure was always 1 bar and the number of filtration cycles amounted to five instead of the described three cycles. Before each trial pre-treatment of the membrane and determination of pure water flux were performed as described in chapter 2.1.3. Each cycle 500 ml permeate were generated. Afterward the membrane was backwashed using 50 ml of the previously generated permeate. Additionally, prior to every cycle membrane flux was assessed with 100 ml of pure water. Parameters measured were the same as for the filtration tests shown in Table 5, except for turbidity $< 1 \mu\text{m}$. Samples were taken from the effluent, treated effluent, permeate after 1st, 3rd and 5th cycle. Additionally samples from the BW water were withdrawn after every 1st, 3rd and 5th cycle for LC-OCD analysis.

Table 3: Trial series of the backwash experiments

| Name of experiment | Ozone dosage [mg/L] | Coagulant concentration [mg/L] | Date |
|--------------------|---------------------|--------------------------------|------------|
| BW I-A | 0 | 0 | 29.09.2009 |
| BW I-B | 6 | 4 | |
| BW I-C | 0 | 0 | 06.10.2009 |
| BW I-D | 6 | 4 | |
| BW II-A | 0 | 4 | 14.10.2009 |
| BW II-B | 6 | | |
| BW II-C | 0 | 4 | 21.10.2009 |
| BW II-D | 6 | | |
| BW III-A | 0 | | 27.10.2009 |
| BW III-B | 2 | 4 | |
| BW III-C | 6 | | |
| BW III-D | 0 | | 28.10.2009 |
| BW III-E | 2 | 4 | |
| BW III-F | 6 | | |
| BW III-G | 10 | | |

2.1.5 Microfiltration (MF) tests

Filtration tests with a MF-membrane were conducted using the same experimental set-up as described for UF tests in chapter 2.1.3. For these trials a NADIR[®] MV020 MF-membrane (MICRODYN-NADIR GmbH, Germany) made of polyvinylidene fluoride (PVDF) with a nominal pore size of 0.2 µm was used. In order to work with comparable permeate flowrates as in the UF tests, the theoretically needed pressure for these MF experiments was calculated (annex, chapter 6.1). Hence, the initial pressure for the MF-trials was 0.2 bar. Filtration of Ruhleben effluent and Ruhleben effluent treated with 4 mg Fe³⁺/L took about 4 hours for the generation of 500 ml permeate. This was approximately four times longer than with the UF-membrane and an applied pressure of 1 bar and made a realisation of the experiments during one day unfeasible. Thus trial with higher pressures of 0.5 and 0.7 bar, respectively were conducted. All trial series conducted with the MF-membrane are listed in Table 4.

Table 4: Trial series of the MF tests

| Name of experiment | Pressure [bar] | Ozone dosage [mg/L] | Coagulant concentration [mg/L] | Date |
|--------------------|----------------|---------------------|--------------------------------|------------|
| MF I-A | 0,2 | 0 | 0,4 | 20.10.2009 |
| | | 0 | 0 | |
| MF I-B | 0,5 | 0 | 4 | |
| | | 6 | 4 | |
| MF I-C | 0,7 | 0 | 0,4 | |

2.2 Analytics

The sum parameters Ultraviolet Absorbance at 254 nm (UVA 254), Absorbance at 436 nm (Colour 436), Dissolved Organic Carbon (DOC), Dissolved Chemical Oxygen Demand (COD_f), Turbidity and Turbidity < 1 µm were determined. The effect of the two pre-treatment steps on the character of DOC, especially the BP fraction, was investigated by use of size

exclusion chromatography (Liquid Chromatography – Organic Carbon Detection (LC-OCD)). Additionally to these parameters phosphate, total soluble phosphorus and residual iron concentration were measured. The standard parameters temperature, pH and electric conductivity were also determined. Table 5 shows all measured parameters with their corresponding pre-filtration through a cellulose nitrate filter.

Table 5: Examined parameters

| Parameter | Filtered through |
|---|--------------------|
| Temperature | - |
| pH | - |
| Electric Conductivity | - |
| Ultraviolet Absorbance at 254 nm (UVA 254) | 0.45 μm |
| Absorbance at 436 nm (Colour 436) | 0.45 μm |
| Dissolved Chemical Oxygen Demand (COD_f) | 0.45 μm |
| Dissolved Organic Carbon (DOC) | 0.45 μm |
| Liquid Chromatography – Organic Carbon Detection (LC-OCD) | 0.45 μm |
| Turbidity < 1 μm | 1.00 μm |
| Phosphate ($\text{PO}_4\text{-P}$) | 0.45 μm |
| Total Soluble Phosphorus ($\text{P}_{\text{T},f}$) | 0.45 μm |
| Residual Iron Concentration | 0.45 μm |

UVA 254 and Colour 436 were measured with a photometer (Lambda 12, Perkin-Elmer, Germany). COD_f analysis was performed with the help of COD Cuvette Tests (LCK 414 COD, HACH LANGE GmbH, Germany). DOC was determined according to DIN EN 1484 (Water analysis – Guidelines for the determination of total organic carbon (TOC) and dissolved organic carbon (DOC); German version EN 1484: 1997) using a HighTOC analyser (Elementar, Germany). LC-OCD analysis was performed utilizing a system of the DOC-Laboratory Dr. Huber (Germany) that quantitatively distinguishes between different fractions of DOC. Turbidity < 1 μm was analysed according to DIN EN ISO 7027. The turbidimeter (Turbidimeter 2100N, HACH LANGE GmbH, Germany) is calibrated with the help of formazine standards and turbidity is directly readable in NTU (Nephelometric Turbidity Unit). Flow injection analysis (FIAstar 5000, FOSS, Germany) was used to analyse phosphate and total soluble phosphorus. Determination of residual iron was realized by atomic absorption spectroscopy (Atomic Absorption, Spectrometer SpectrAA400, Graphite Tube Atomizer GTA 96, Varian Deutschland GmbH, Germany).

2.2.1 Turbidity < 1 μm

As colloids between 10 - 450 nm are known to be exceptionally responsible for membrane fouling, a closer look on these small colloids is obtained by a 1 μm filtration. Figure 5 depicts the steel filter, which is used for the preparation of 1 μm samples for the turbidity measurement. This special filter is used, because it allows filtration without formation of a cake layer, which would prevent particles even smaller than 1 μm from merging into the permeate. The steel filter is wrapped with an aquarium tube (left picture in Figure 5). Compressed air, coming out of this aquarium tube, creates bubbles, which enclose the filter and prevent the formation of a cake layer.



Figure 5: Steel filter used for the 1 μm filtration

3 Results

3.1 Filtration Tests

Diagrams in this chapter are chosen exemplarily and represent typical results of the corresponding trial series. Data of all parameters and trial series are listed in the annex (chapter 6.3). Additionally, all diagrams of flux decline curves, BW trials and BP peaks of the LC-OCD analysis are shown in chapter 6.2.2 and chapter 6.2.4. For a better overview, the annex contains also diagrams of the parameters turbidity $< 1 \mu\text{m}$ (chapter 6.2.7) and residual iron (chapter 6.2.6), as they were not consistent during all trial series. Diagrams of the ozonation unit showing the in-gas, off-gas and dissolved ozone concentration are depicted in chapter 6.2.1. Diagrams for BW trials are exemplarily shown in the corresponding sections of chapter 6.2.

In most of the diagrams bars of a distinct colour present samples after application of 0-6 mg Fe^{3+}/L and corresponding samples with additional pre-ozonation are shown as striped bars of the same colour. Different shades of a distinct colour of plain-coloured and striped bars, respectively, indicate the time of sample drawing. Samples drawn before UF are shown in a more intense shade of colour than samples drawn after UF.

Results of data after UF for COD_f , DOC, UVA 254 and Colour 436 were only a few percentage points below those after $0.45 \mu\text{m}$ filtration. This deviation is in the range of measuring inaccuracy. Therefore only samples after $0.45 \mu\text{m}$ filtration were taken into consideration for calculation of elimination rates.

3.1.1 Flux decline and filtration time

Flux decline results from Amicon filtration tests are shown as normalized flux J/J_0 over permeate volume. J_0 represents the pure water flux, whereas J is the measured flux. This presentation allows for a better comparison of different flux decline curves, as all curves start at $J/J_0=1$. In each experiment 500 ml treated or untreated Ruhleben effluent has been filtered. Flux decline curves of samples treated without pre-ozonation are depicted in red (0 mg Fe^{3+}/L), orange (2 mg Fe^{3+}/L) and yellow (6 mg Fe^{3+}/L), whereas corresponding samples pre-treated with ozone are displayed in different shades of green. Average flux decline for untreated Ruhleben effluent after filtration of 500 ml was 90 %.

In Figure 6 flux decline curves of trial series with a constant pre-ozonation dosage of 2 mg O_3/L (Figure 6b) and 10 mg O_3/L (Figure 6a), respectively, and two coagulant concentrations (2 and 6 mg Fe^{3+}/L) are presented. Pre-ozonation without subsequent coagulation results in a slight flux increase of 2 % applying 2 mg O_3/L and leads to a maximum flux increase of 3 % with an application of 10 mg O_3/L (Figure 6a). The effect of coagulation exceeds the effect of pre-ozonation clearly. Both trials reveal a remarkable flux increase of approximately 10 % with coagulant concentrations of 2 mg Fe^{3+}/L , whereas application of higher coagulant concentrations of 6 mg Fe^{3+}/L lead only to an additional slight flux increase of 3 %. Application of ozone raises the flux additionally. This effect is hardly detectable with low ozone dosages of 2 mg O_3/L (Figure 6b) but clearly visible with high

ozone dosages of 10 mg O₃/L (Figure 6a) resulting in an additional flux increase of 6 % with the application of 6 mg Fe³⁺/L. Application of 10 mg O₃/L and subsequent coagulation with 6 mg Fe³⁺/L results in the maximum flux increase of 20 % compared to the untreated Ruhleben effluent.

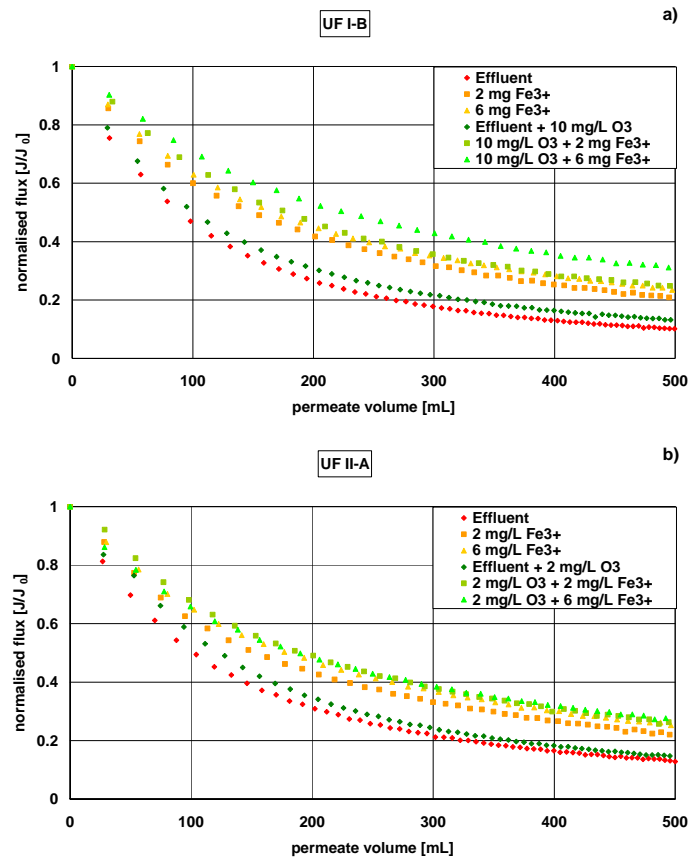

Figure 6: Flux decline curves for different coagulant dosages of 0-6 mg Fe³⁺/L with and without pre-ozonation (Figure 6a: 10 mg O₃/L, Figure 6b: 2 mg O₃/L)

As visible in Figure 7 flux decline decreases significantly with application of FeCl₃, and, as it had been in previous trial series described in Figure 6, higher coagulant concentrations of 6 mg Fe³⁺/L (Figure 7b) again result in a comparable higher flux of 12 %. Combining pre-ozonation and coagulation improves the filtration performance and becomes apparent due to the additional higher flux. This synergetic effect deriving from both treatment steps, pre-ozonation and coagulation, increases with the concentration of the applied coagulant. Application of 2 mg Fe³⁺/L results in a successive flux increase of 2 %, whereas coagulation with 6 mg Fe³⁺/L leads to a stepwise increase of 3 % in flux. Thus, maximum flux after filtration of 500 ml effluent is achieved with 10 mg O₃/L pre-ozonation and subsequent coagulation with 6 mg Fe³⁺/L (Figure 7b). This corresponds to an improvement in flux at the end of the experiment of 20 % compared with the effluent without pre-treatment and 9 % compared to the coagulated sample. This maximum flux increase is equal to the maximum flux improvement of trial UF I-B (Figure 6a), conducted under the same conditions (10 mg O₃/L and 6 mg Fe³⁺/L). Oxidation effects on the surface of the membrane can be excluded as in none of the samples free dissolved ozone was present after the pre-ozonation step, as the off-gas ozone was completely stripped with pure oxygen.

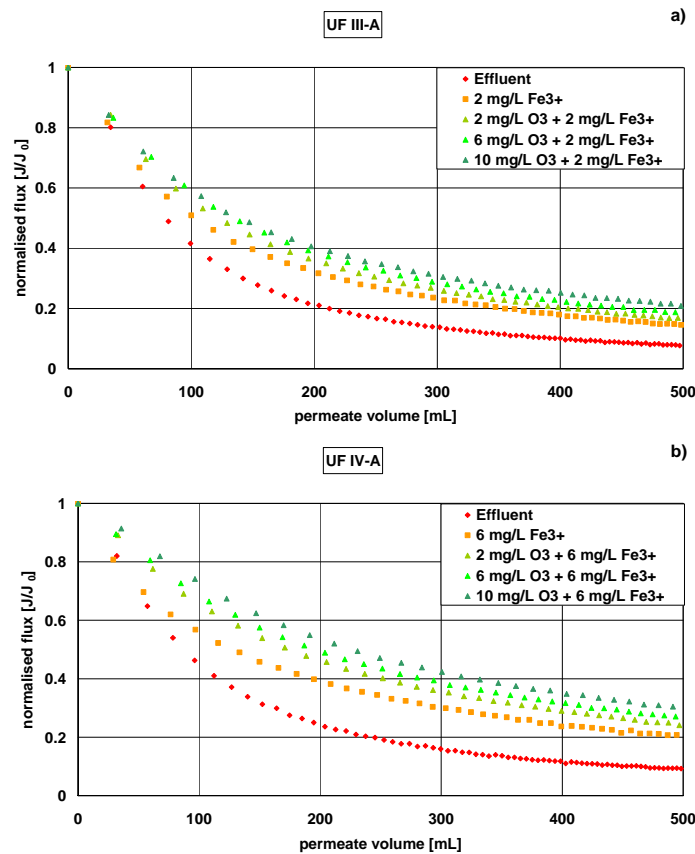

Figure 7: Flux decline curves for different ozone dosages of 0-10 mg O₃/L and a constant FeCl₃ addition of 2 mg Fe³⁺/L (Figure 7a) and 6 mg Fe³⁺/L (Figure 7b)

Increase of filtration performance and especially the positive effect of pre-ozonation become even more considerable in Figure 8 showing the filtration times needed for each sample corresponding to both trials of Figure 7. A combination of 10 mg O₃/L and subsequent coagulation with 2 mg Fe³⁺/L diminishes the filtration time needed for 500 ml Ruhleben effluent by 51 % compared with the effluent without pre-treatment (Figure 8a), whereas filtration time is reduced by 61 % applying the same pre-ozonation dosage followed by a coagulation with 6 mg Fe³⁺/L (Figure 8b). Comparing coagulated samples and samples treated with a combination of pre-ozonation and subsequent coagulation, filtration time is reduced by a maximum of 28 % (2 mg Fe³⁺/L) and 33 % (6 mg Fe³⁺/L), respectively, compared to the flux of the coagulated sample (ozone effect alone).

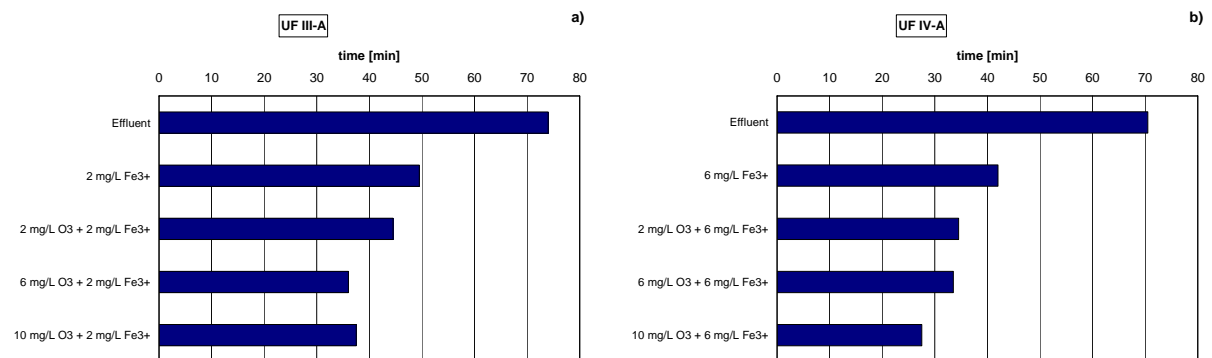

Figure 8: Filtration times for different ozone dosages of 0-10 mg O₃/L and a constant coagulant addition of 2 mg Fe³⁺/L (Figure 8a) and 6 mg Fe³⁺/L (Figure 8b)

Conclusion:

- ⇒ Pre-ozonation without subsequent coagulation results in a slight flux increase of approximately 2 %, independent on ozone dosage.
- ⇒ Coagulation with 2 mg Fe³⁺/L (6 mg Fe³⁺/L) increases the flux by 10 % (13 %) and minimizes filtration time by 33 % (40 %).
- ⇒ Pre-ozonation raises the flux additionally. This effect is hardly detectable with low ozone dosages of 2 mg O₃/L but application of 10 mg O₃/L results in an additional significant flux increase of approximately 6 %.
- ⇒ Combination of pre-ozonation with 10 mg O₃/L and subsequent coagulation with 2 mg Fe³⁺/L (6 mg Fe³⁺/L) leads to a decrease in filtration time of 51 % (61 %) compared to the effluent without pre-treatment, whereas a comparison with the coagulated effluent results in decreasing filtration times of 28 % (2 mg Fe³⁺/L) and 33 % (6 mg Fe³⁺/L), respectively, compared to the flux of the coagulated sample.
- ⇒ Maximal flux increase of 20 % (9 %) after filtration of 500 ml is achieved with an ozone dosage of 10 mg O₃/L and subsequent coagulation with 6 mg Fe³⁺/L in comparison with the effluent without pre-treatment (coagulated effluent).
- ⇒ The synergetic effect deriving from a combination of pre-ozonation and coagulation increases with the concentration of the applied coagulant.

3.1.2 Total Soluble Phosphorus (P_{T,f})

Effluent concentrations of Total Phosphorus (P_T) varied during the whole project between 188 µg P/L and 763 µg P/L. Average concentration of P_T was 338 ± 175 µg/L. Diagrams in Figure 9 and Figure 10 only show Total Soluble Phosphorus (P_{T,f}) data as UF totally retains the fraction of particulate phosphorus. Therefore only P_{T,f} is discussed. Error bars in these Figures are plotted but are invisible because of their small size. Average P_{T,f} concentrations of the effluent without pre-treatment amounted to 126 ± 50 µg P/L. For all trials the average concentration of phosphate (PO₄-P) was 76 ± 41 µg P/L. An overview of all PO₄-P data measured is given in the annex (chapter 6.3.2).

P_{T,f} data of trials with varying coagulant concentration and fixed ozone dosages are shown in Figure 9. There is no significant impact of ozonation on the concentration of P_{T,f} visible, but coagulation leads to a decline in the amount of P_{T,f}. Application of 2 mg Fe³⁺/L leads to an average P_{T,f} concentration of 46 ± 9 µg P/L, whereas 6 mg Fe³⁺/L result in an additional reduction of P_{T,f} concentration and average values of 36 ± 6 µg P/L were obtained.

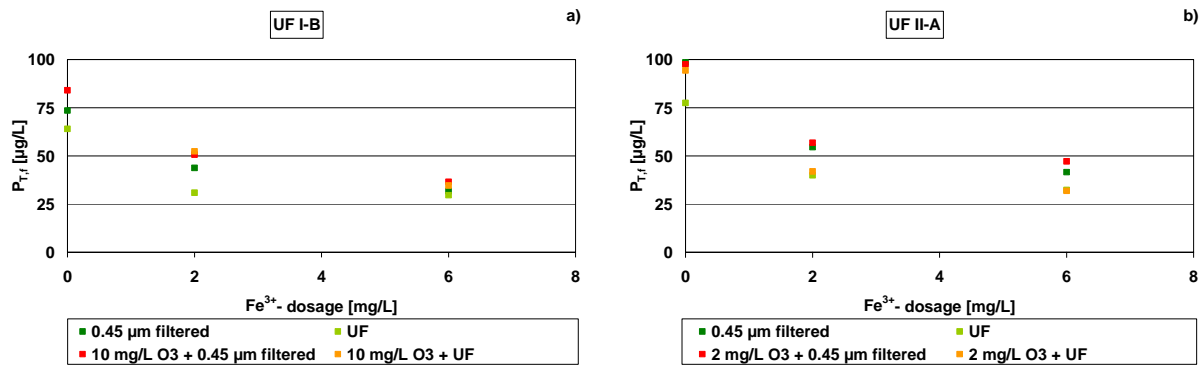

Figure 9: Phosphorus concentrations of Ruhleben effluent after 0.45 µm filtration and after UF for different Fe^{3+} -concentrations of 0 - 6 mg Fe^{3+}/L with 2 mg O_3/L (Figure 9b) and 10 mg O_3/L (Figure 9a) pre-ozonation

In Figure 10 results for $P_{T,f}$ concentrations of trials with a varying ozone dosage of 0-10 mg O_3/L and a fixed coagulant concentration of 2 mg Fe^{3+}/L (Figure 10a) and 6 mg Fe^{3+}/L (Figure 10b) are displayed. As in Figure 9 no significant effect of pre-ozonation is visible. Samples of the permeate seem to be a little lower in general during trial series UF II-A, but in Figure 10b showing trial series UF IV A this effect seems negligible. Pre-treatment with different ozone dosages and a coagulant concentration of 2 mg Fe^{3+}/L lead to an average $P_{T,f}$ concentration after UF of $52 \pm 4 \mu\text{g P/L}$ (Figure 10a). An increase of coagulant concentration to 6 mg Fe^{3+}/L results in a lower average $P_{T,f}$ concentration after UF of approximately $41 \pm 6 \mu\text{g P/L}$. Compared to corresponding $P_{T,f}$ concentrations illustrated in Figure 9 during these trials a slightly minor reduction in $P_{T,f}$ is observed.

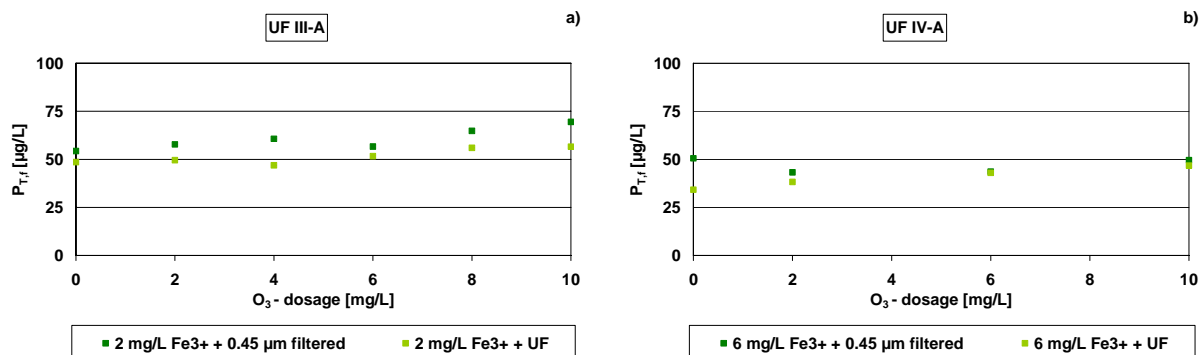

Figure 10: Phosphorus concentrations of Ruhleben effluent after 0.45 µm filtration and after UF for Fe^{3+} -concentrations of 2 mg Fe^{3+}/L (Figure 10 a) and 6 mg Fe^{3+}/L (Figure 10b) and ozone dosages of 0-10 mg O_3/L

A diagram of $P_{T,f}$ concentrations in the permeate against $P_{T,f}$ concentrations in the effluent for different coagulant concentrations of 2, 4 and 6 mg Fe^{3+}/L is depicted in Figure 11. It is clearly visible that in approximately 80 % of the data points coagulant concentrations of 2 mg Fe^{3+}/L result in phosphorus concentrations $< 60 \mu\text{g P/L}$. An increase in coagulant concentration to 4 mg Fe^{3+}/L leads to a reduction in $P_{T,f}$ of concentrations $< 50 \mu\text{g P/L}$. Application of higher coagulant concentrations (4 mg Fe^{3+}/L) does not lead to a further reduction in concentrations of $P_{T,f}$.

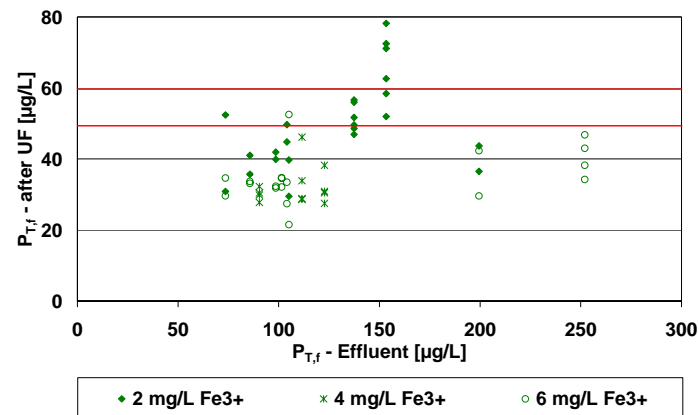

Figure 11: $P_{T,f}$ concentration in the permeate against $P_{T,f}$ concentrations in the effluent for different coagulant concentrations

Conclusion:

- ⇒ 2 mg Fe^{3+} /L leads to a concentration < 60 $\mu\text{g P/L}$.
- ⇒ Application of 4 mg Fe^{3+} /L reduces $P_{T,f}$ to a concentration < 50 $\mu\text{g P/L}$.
- ⇒ Coagulant concentrations > 4 mg Fe^{3+} /L do not result in an additional significant reduction of $P_{T,f}$ concentrations.
- ⇒ These findings are independent of pre-ozonation.

3.1.3 Liquid Chromatography – Organic Carbon Detection (LC-OCD)

A typical LC-OCD diagram is illustrated in Figure 12. It derives from an experiment with varying pre-ozonation dosage from 0-10 mg O_3 /L and a fixed coagulant concentration of 2 mg Fe^{3+} /L. This diagram shows a decrease in BP concentration and an increase of the humic substances peak. Ruhleben effluent is always depicted as a black line and coagulated samples as red lines. In Figure 12 to Figure 16 blue and green lines represent samples treated with ozone.

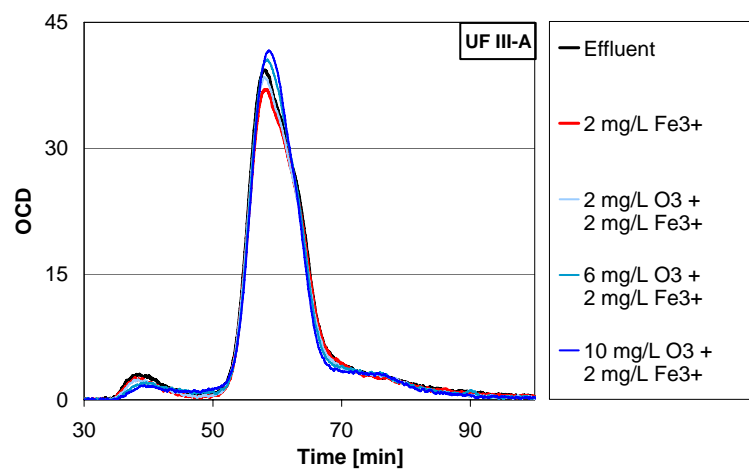

Figure 12: LC-OCD diagram of Ruhleben secondary treated effluent with ozone dosages of 0-10 mg O_3 /L and a fixed coagulant concentration of 2 mg Fe^{3+} /L

As BP are known as main foulants during UF, Figure 13 to Figure 16 reveal a closer look at the BP fraction, eluting approximately between 33 and 48 minutes. BP peaks before UF are depicted in Figure 13a to Figure 16a, whereas Figure 13b to Figure 16b show BP peaks after UF.

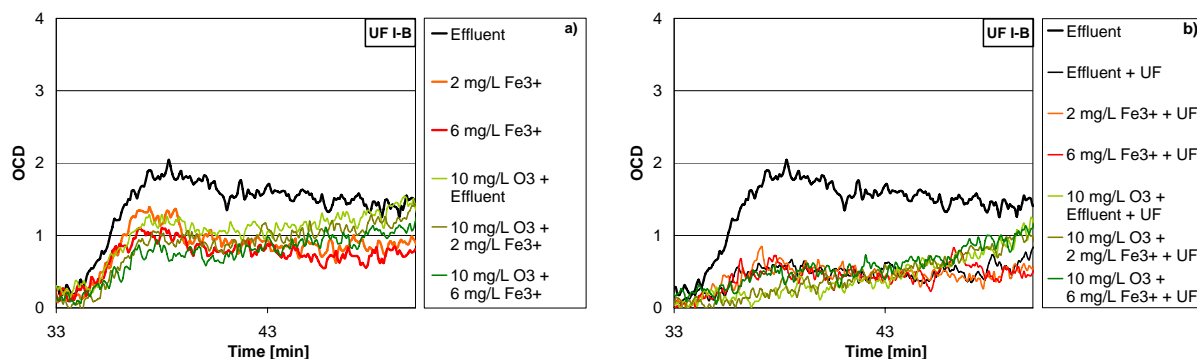

Figure 13: Biopolymer peak of Ruhleben secondary treated effluent analysed by LC-OCD with coagulant concentrations from 0 - 6 mg Fe³⁺/L and an ozone dosage of 10 mg O₃/L before (Figure 13a) and after UF (Figure 13b)

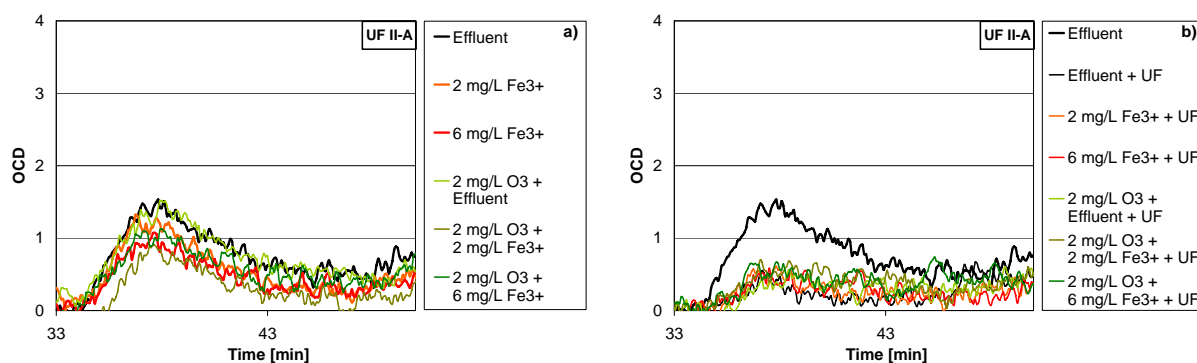

Figure 14: Biopolymer peak of Ruhleben secondary treated effluent analysed by LC-OCD with coagulant concentrations from 0 - 6 mg Fe³⁺/L and an ozone dosage of 2 mg O₃/L before (Figure 14a) and after UF (Figure 14b)

Figure 13 and Figure 14 show BP peaks from trials with a constant ozone dosage of 2 and 10 mg O₃/L, respectively, and two different coagulant concentrations (2 and 6 mg Fe³⁺/L). In both trials the BP peak representing the amount of BP in this sample, decreases with increasing dosage of FeCl₃. As visible in Figure 13a increasing the ozone dosage results in a further decline in the amount of BP eluting with the main BP peak around 38 minutes. Green lines, representing the ozonated samples, are always located below the corresponding sample without pre-ozonation (black and red lines). Simultaneously, ozonation with high ozone dosages of up to 10 mg O₃/L leads to a significant increase of BP with a smaller size, eluting around the 48 minutes (Figure 13a, green lines). The same increase is observed for the permeate. Green lines representing ozonated samples in the permeate with an elution time of approximately 48 minutes are clearly located above none ozonated permeate samples (black and red lines). As a shift to smaller BP is observed, ozone seems to transform BP to smaller BP fragments with longer retention times. In contrast to a change in the amount of BP another possibility is a change in the amount of BP that is detected by LC-OCD due to high ozone dosages. No conclusion can be drawn for the BP fraction of the samples treated with 2 mg O₃/L (Figure 14b), as there is no significant change in the BP peaks after pre-ozonation.

In general it is worth mentioning, that amounts of BP were relatively low during these trial series.

In Figure 15 and Figure 16 results for the BP fraction of Ruhleben secondary treated effluent with coagulant concentrations of 2 mg Fe³⁺/L (Figure 15) and 6 mg Fe³⁺/L (Figure 16) and different ozone dosages (0-10 mg O₃/L) before and after UF are presented. Black lines again represent the effluent without pre-treatment, red lines the coagulated effluent and the set of blue lines stands for pre-ozonated samples.

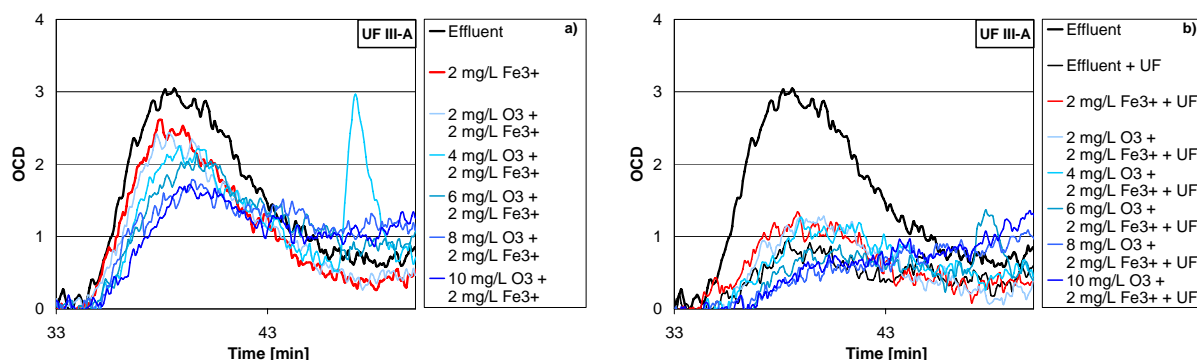

Figure 15: Biopolymer peak of Ruhleben secondary treated effluent analysed by LC-OCD with a coagulant concentration of 2 mg Fe³⁺/L and different ozone dosages (0-10 mg O₃/L) before (Figure 15a) and after UF (Figure 15b)

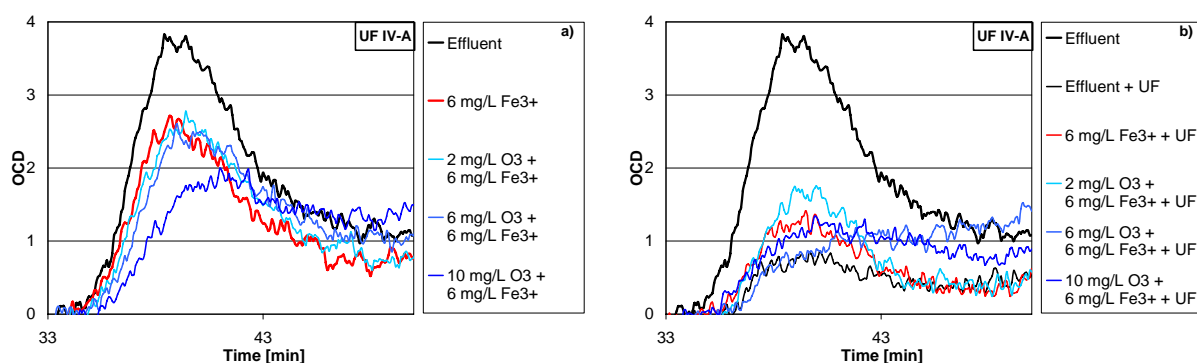

Figure 16: Biopolymer peak of Ruhleben secondary treated effluent analysed by LC-OCD with a coagulant concentration of 6 mg Fe³⁺/L and different ozone dosages (0-10 mg O₃/L) before (Figure 16a) and after UF (Figure 16b)

The BP fractions illustrated in Figure 15 and Figure 16 show a significant decrease for the samples only treated with coagulant. This removal in the amount of BP increases with increasing coagulant concentration from 2 mg Fe³⁺/L (Figure 15a, red line) to 6 mg Fe³⁺/L (Figure 16a, red line). A further decrease in the amount of BP and a shift to smaller molecules is observed with increasing dosage of ozone. This effect is more distinct with low coagulant concentrations (Figure 15a, 2 mg Fe³⁺/L). There is an overall change in the quantity of BP as the amount of BP eluting with the main BP peak around 38 minutes decreases clearly, whereas the amount of BP eluting around 48 minutes only increases slightly. These findings, equally to the results of Figure 13a, indicate a change in the structure as the amount of smaller BP increases. This increase is also observed for the samples after UF. Hence these smaller BP are not retained by the UF. In contrast, the amount of BP eluting around 38 minutes (higher molecular size) decreases significantly after UF. Thus this BP fraction is to a great extent retained by the UF leading to a decline in flux.

Conclusion:

- ⇒ The amount of BP decreases significantly after application of coagulant. This effect increases with increasing coagulant concentration.
- ⇒ Pre-ozonation has two effects on BP:
 - Decrease in the amount of BP eluting with the main peak around 38 minutes. This effect is more distinctive with low coagulant concentrations and increases with increasing ozone dosages.
 - High ozone dosages result in a shift to smaller molecules, which do not contribute to membrane fouling.
- These effects either result from fragmentation of BP molecules or the detectable amount of BP changes due to pre-ozonation.

3.1.4 Dissolved Organic Carbon (DOC)

DOC varied slightly during the project and was 10.9 ± 0.8 mg/L. A slight decrease of DOC due to coagulation can be observed in Figure 17 as well as in Figure 18. Coagulation with 6 mg Fe^{3+} /L leads to a maximum reduction of 10 % (Figure 17b), corresponding to a minimum DOC concentration of 9.1 mg/L. Increases of DOC in experiments with pre-ozonation can be explained with dissolving of particulate organic carbon due to ozonation.

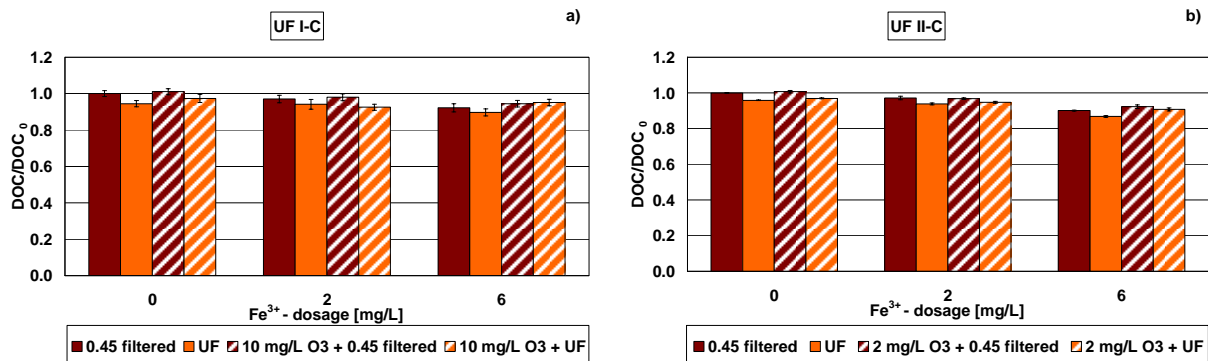

Figure 17: Relative DOC concentration for different coagulant dosages of 0-6 mg Fe^{3+} /L with and without pre-ozonation (Figure 17a: 2 mg O_3 /L, DOC_0 : 9.8 mg/L; Figure 17b: 10 mg O_3 /L, DOC_0 : 10.1 mg/L)

Figure 18 shows the results for a varying ozone dosage (0-10 mg O_3 /L) and a constant FeCl_3 concentration of 2 and 6 mg Fe^{3+} /L, respectively. It is clearly visible, that pre-ozonation has no effect on the removal of DOC. Coagulation with 2 mg Fe^{3+} /L results in an average reduction of 2 % DOC (Figure 13a) whereas 6 mg Fe^{3+} /L decrease DOC by 6 % (Figure 13b).

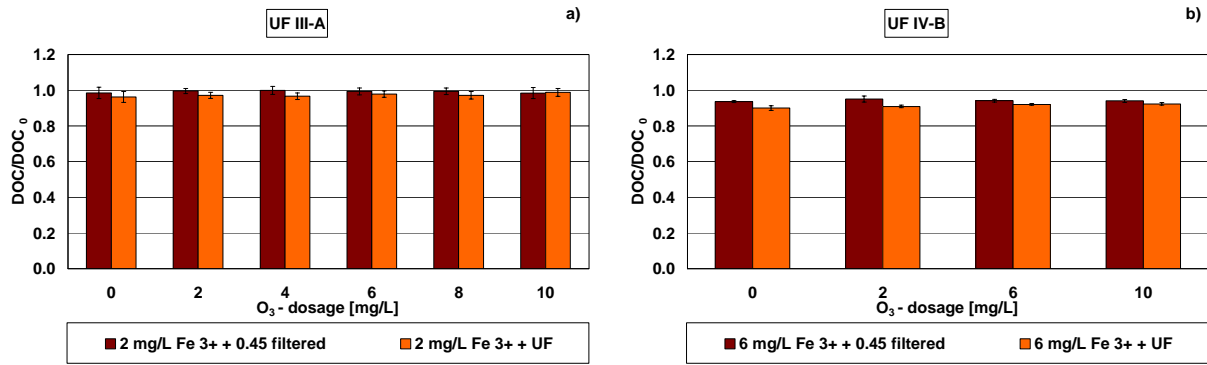

Figure 18: Relative DOC concentration for different ozone dosages of 0-10 mg O₃/L and a constant FeCl₃ addition of 2 mg Fe³⁺/L (Figure 18a, DOC₀: 9.7 mg/L) and 6 mg Fe³⁺/L (Figure 18b, DOC₀: 10.9 mg/L)

3.1.5 Residual Iron

Results of residual iron concentrations after 0.45 μm filtration and after UF are presented in Figure 19 and Figure 20. Ozone dosage is fixed in trials presented in Figure 19 and coagulant concentrations vary, whereas during the experiments shown in Figure 20 ozone dosages vary and coagulant concentrations are fixed. Initial residual iron concentrations of the untreated Ruhleben effluent after 0.45 μm filtration were 24.9 ± 3.6 μg/L during trial series UF I and UF II, whereas a higher initial residual iron concentration after 0.45 μm filtration of 41.2 ± 1.2 μg/L was measured during trial series UF III and UF IV.

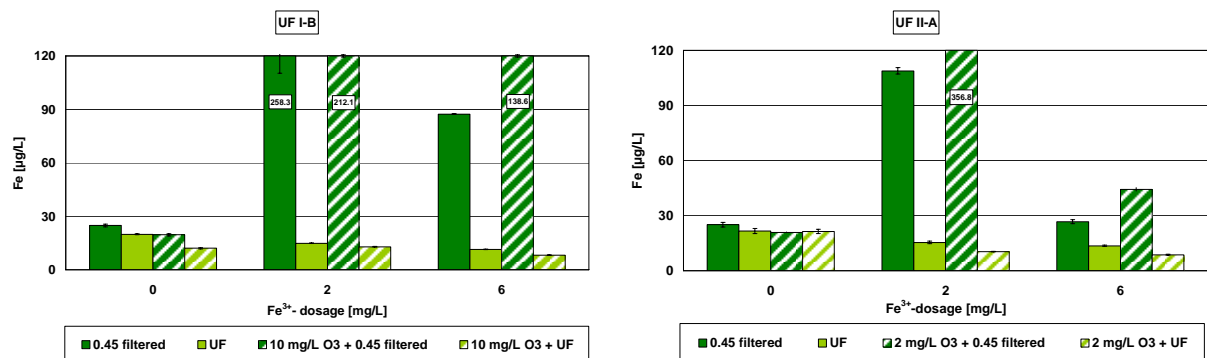

Figure 19: Residual iron concentrations of Ruhleben effluent after 0.45 μm filtration and after UF for different Fe³⁺-concentrations of 0 - 6 mg Fe³⁺/L with pre-ozonation dosages of 2 mg O₃/L (UF II-A) and 10 mg O₃/L (UF I-B)

Concentrations for residual iron after 0.45 μm filtration increase with the application of FeCl₃ (Figure 19). This increase is higher with 2 mg Fe³⁺/L than with 6 mg Fe³⁺/L resulting in a maximum residual iron concentration of 258 μg/L (Figure 19a). Independent on the applied ozone dosage and despite of the huge variability in residual iron concentrations after 0.45 μm filtration an additional increase in residual iron concentrations is observed predominantly after pre-ozonation. This increase in colloidal iron comes to a maximum concentration of 357 μg/L after pre-ozonation with 2 mg O₃/L and subsequent coagulation with 2 mg Fe³⁺/L (Figure 19b). Thus it comes to a filtering function of the UF-membrane due to the increased colloidal iron making the cake layer more dense and an increase in flux decline. Most probably in samples with pre-ozonation organo-metal-complexes are formed which can not contribute to the process of coagulation any more. In trial series UF I-B depicted in Figure 19a the quantity of iron that is not available for the process of coagulation due to pre-ozonation amounts to

11 % for coagulation with 2 mg Fe³⁺/L and 2 % for coagulation with 6 mg Fe³⁺/L. Hence, with the application of low FeCl₃ concentrations of 2 mg Fe³⁺/L the percentage of coagulant that is lost for the process of coagulation is significant. As the percentage of formed organo-metal-complexes decreases with increasing iron dosage, the synergetic effect of pre-ozonation and coagulation on the filtration performance also increases with increasing coagulant concentration. After UF residual iron concentration is always low, even lower than in the effluent without pre-treatment. The average concentration of residual iron in trial UF I-B and UF II-A after UF was $14.2 \pm 4.6 \mu\text{g/L}$.

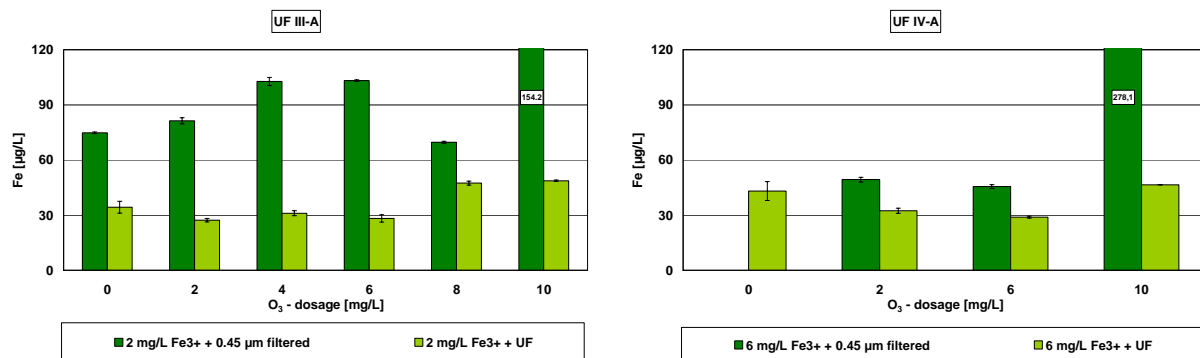

Figure 20: Residual iron concentrations of Ruhleben effluent after 0.45 µm filtration and after UF for Fe³⁺-concentrations of 2 mg Fe³⁺/L (UF III-A) and 6 mg Fe³⁺/L (UF IV-A) and ozone dosages of 0-10 mg O₃/L

In Figure 20 there is no distinct effect of pre-ozonation with different ozone dosages visible. Results of these trials show again that lower dosages of FeCl₃ lead to higher concentrations of residual iron. Diagrams of all trial series conducted are displayed in the annex (chapter 6.2.6). Considering results of all trials, in most of the cases residual iron concentration increases with increasing ozone dosage.

Conclusion:

- ⇒ Concentrations of residual iron (0.45 µm filtrate) increase with the application of FeCl₃. This increase is higher with low coagulant concentrations of 2 mg Fe³⁺/L than with 6 mg Fe³⁺/L.
- ⇒ Pre-ozonation in combination with coagulation causes increased residual iron concentrations most probably due to complexation.
- ⇒ Residual iron concentration after 0.45 µm filtration showed a tendency to increase with ozone dosage.
- ⇒ 10 mg O₃/L (2 mg O₃/L) combined with 2 mg Fe³⁺/L lead up to 212 µg/L (357 µg/L) residual iron.
- ⇒ No significant increase in residual iron concentration after UF-membrane is observed, thus the iron colloids are larger in diameter than the UF pores.

3.1.6 Turbidity < 1 µm

Average turbidity during trial series UF I and UF II was 2.9 ± 0.6 NTU. Figure 21 and Figure 22 display results of turbidity < 1 µm measurements. Exemplarily only four results of

turbidity < 1 μm measurements are displayed. Chapter 6.2.1 contains all diagrams showing turbidity < 1 μm data. Figure 21 depicts samples treated with 10 mg O_3/L and different subsequent coagulant concentrations of 0-6 mg Fe^{3+}/L whereas in Figure 22 pre-ozonation was conducted with 2 mg O_3/L . Even though the shown results in each of these figures derive from the same trial series no evaluation of these data was performed as the results are inconsistent and therefore a comparison of different trial series was not useful. Moreover no conclusion concerning a context between turbidity < 1 μm and flux decline could be drawn. However it is noteworthy, that in several trials, for example UF I-C (Figure 21), turbidity < 1 μm was always significantly lower for pre-ozonated samples, which correlates with the increasing flux after pre-ozonation. Contrary to the thesis that turbidity < 1 μm correlates with flux decline, higher fluxes are observed with increasing coagulant concentration (Figure 6), whereas in most cases turbidity < 1 μm was higher with 6 mg Fe^{3+}/L than with 2 mg Fe^{3+}/L . As colloids in the range of 10-450 nm were identified as main foulants during UF, the 1 μm filter used in these trials seems not adequate, as the fraction 450-1000 nm also passes this 1 μm filter and contributes to an unknown extent to turbidity measurements. Therefore more research is necessary, especially with a more appropriate filter, to check if after all there exists any correlation and if there is a chance to predict flux decline by turbidity measurement.

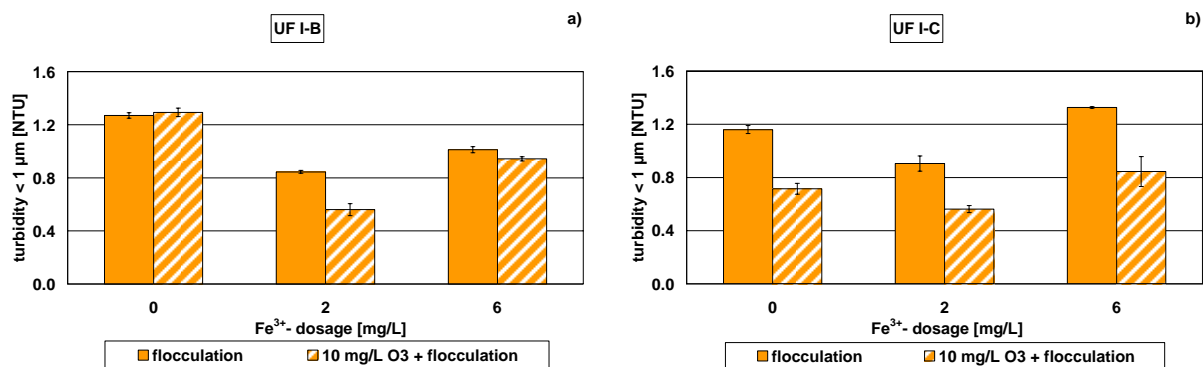

Figure 21: Turbidity < 1 μm for samples treated with 10 mg O_3/L and different subsequent coagulant dosages of 0-6 mg Fe^{3+}/L

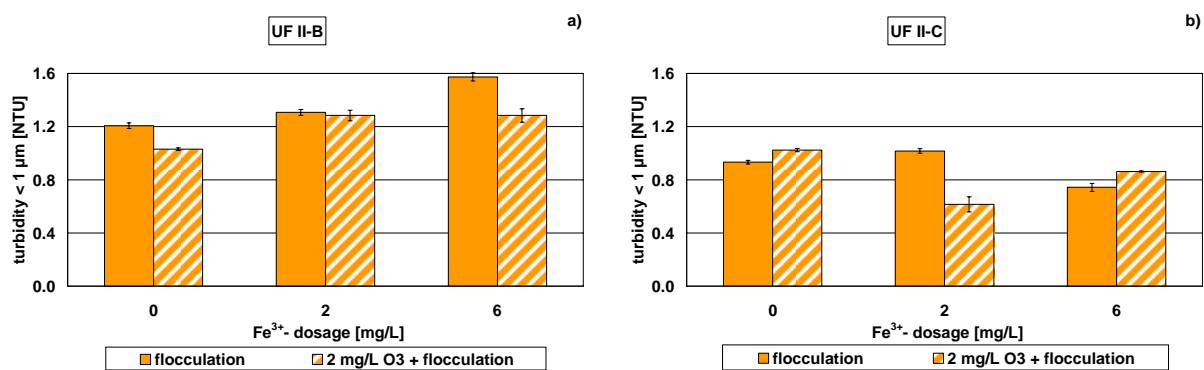

Figure 22: Turbidity < 1 μm for samples treated with 2 mg O_3/L and different subsequent coagulant dosages of 0-6 mg Fe^{3+}/L

3.1.7 Temperature, pH and electric conductivity

Temperature was nearly constant at 22.9 ± 1.5 $^{\circ}\text{C}$, as all experiments were conducted at room temperature. pH was always measured before and after each treatment process. Due to a high

buffer capacity of the secondary treated effluent of Ruhleben it showed only a slight increase from 7.3 ± 0.1 before to 7.9 ± 0.0 after pre-ozonation with $2 \text{ mg O}_3/\text{L}$ and 8.0 ± 0.1 after pre-treatment with $10 \text{ mg O}_3/\text{L}$. Increases in pH during ozonation occur most likely due to stripping of inorganic carbon. Conductivity is the third parameter which has been measured by default. It also showed a small variance and was approximately $1126 \pm 138 \mu\text{S}/\text{cm}$, depending on the predominant weather conditions.

3.1.8 Ultraviolet Absorbance at 254 nm (UVA 254)

Figure 23 and Figure 24 show the relative absorbance of UVA 254 characterizing the amount of aromatic compounds. Initial values of UVA 245 were approximately $28.05 \pm 1.38/\text{m}$. The addition of FeCl_3 leads to a constant decrease in relative absorbance with a maximum of 18 % of the initial relative absorbance (Figure 23a). Independent of coagulant concentration pre-ozonation leads to a decline of UVA 254 of 12 % (Figure 23b) and 42 % (Figure 23a) respectively, depending on the ozone dosage, indicating on the oxidation of aromatic structures. Comparing pre-ozonated samples among themselves an analogue decline of 10 % is observed for these samples. It is noticeable that there is no synergetic effect concerning pre-ozonation and subsequent coagulation, because the initial effect of 12 % and 42 % decrease is nearly constant, independent on the different combinations of pre-ozonation and coagulation. Altogether the maximum reduction (achieved with $10 \text{ mg O}_3/\text{L}$ pre-ozonation and subsequent coagulation with $6 \text{ mg Fe}^{3+}/\text{L}$) of UVA 254 is 56 % (Figure 23a).

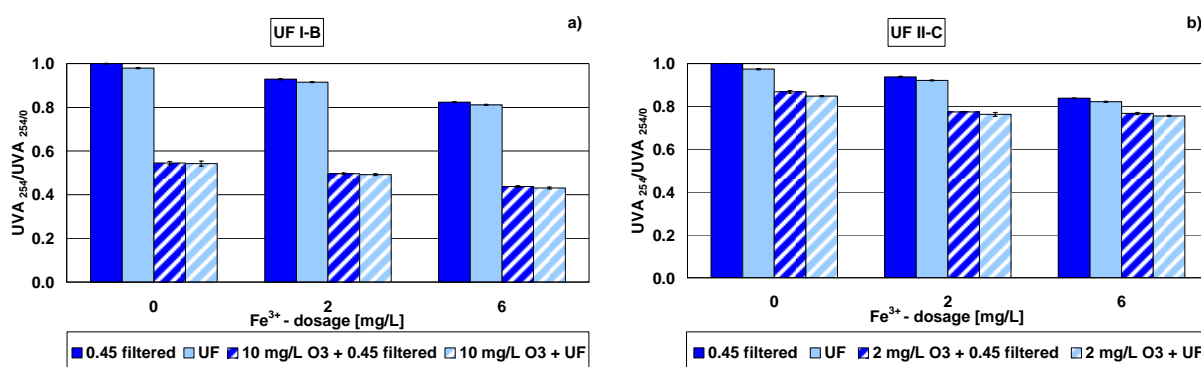

Figure 23: Relative UVA 254 for different coagulant dosages of 0-6 mg Fe^{3+}/L with and without pre-ozonation (Figure 23a: $2 \text{ mg O}_3/\text{L}$, $\text{UVA } 254_0$: $26.70/\text{m}$; Figure 23b: $10 \text{ mg O}_3/\text{L}$, $\text{UVA } 254_0$: $27.08/\text{m}$)

As displayed in Figure 24, increasing ozone dosages result in a constant decrease of relative UVA 254. Comparing Figure 24a and Figure 24b it becomes clear, that the effect of pre-ozonation exceeds the effect obtained due to coagulation, especially with ozone dosages $> 2 \text{ mg O}_3/\text{L}$. The maximum decline applying $10 \text{ mg O}_3/\text{L}$ amounts to 52 %, independent on coagulant concentration.

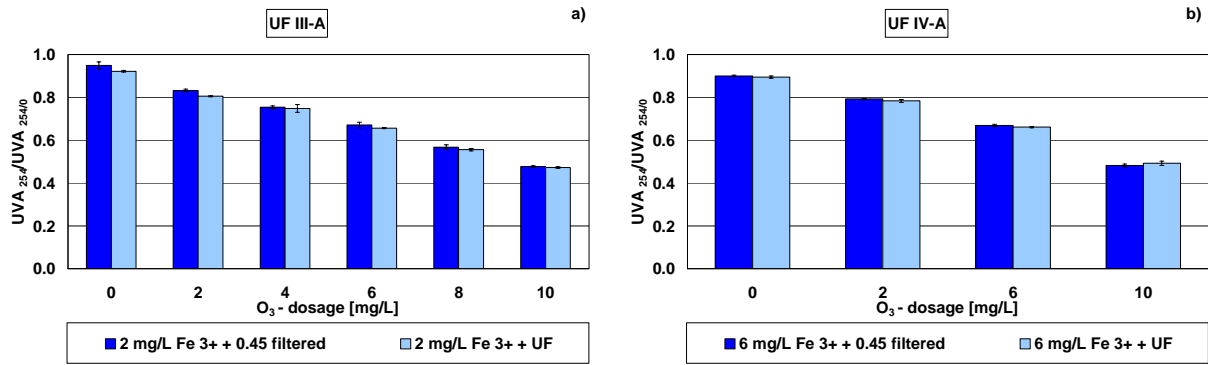

Figure 24: Relative UVA 254 for different ozone dosages of 0-10 mg O₃/L and a constant FeCl₃ addition of 2 mg Fe³⁺/L (Figure 24a, UVA 254₀: 27.00/m) and 6 mg Fe³⁺/L (Figure 24b, UVA 254₀: 27.04/m), respectively

In both trial series there is no significant difference between samples before and samples after UF.

3.1.9 Absorbance at 436 nm (Colour 436)

Results of Colour 436 primarily characterizing the amount of humic substances are depicted in Figure 25 and Figure 26 as relative absorbance. Initial values for Colour 436 in Figure 25 were 1.43/m and 1.68/m, respectively, whereas in Figure 26 Colour 436₀ was 1.72/m and 1.65/m, respectively. Average Colour 436 was 1.65 ± 0.11/m. As observed with UVA 254, increasing dosages of FeCl₃ decrease Colour 436 down to 82 % of the initial absorbance (Figure 25). An analogue decline of 11 % is observed for samples which were treated with ozone before coagulation. The initial effect of pre-ozonation is 39 % (2 mg O₃/L) and 74 % (10 mg O₃/L), respectively. As these initial effects are constant for each trial series, again no synergetic effect is obtained by the combination of pre-ozonation and coagulation. The maximum reduction in Colour 436 is 88 % (10 mg O₃/L and 6 mg Fe³⁺/L).

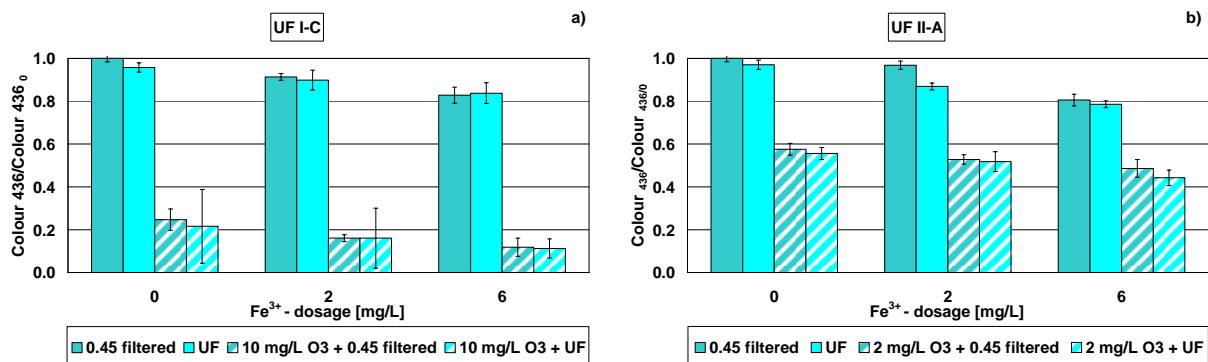

Figure 25: Relative Colour 436 for different coagulant dosages of 0-6 mg Fe³⁺/L with and without pre-ozonation (Figure 25a: 2 mg O₃/L, Colour 436₀: 1.43/m; Figure 25b: 10 mg O₃/L, Colour 436₀: 1.68/m)

A constant decline of relative Colour 436 is revealed by the data presented in Figure 26. As with UVA 254, a comparison of different coagulant concentrations of 2 and 6 mg Fe³⁺/L, respectively, combined with an increasing ozone dosage of 0-10 mg O₃/L, reveals approximately the same maximum reduction of Colour 436 (85 %). The effect of ozonation again exceeds the effect of coagulation especially with ozone dosages > 6 mg O₃/L.

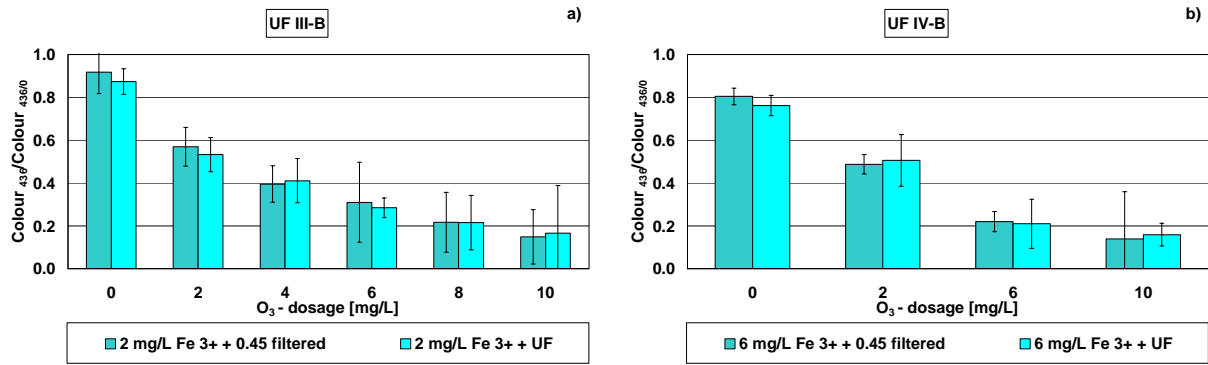

Figure 26: Relative Colour 436 for different ozone dosages of 0-10 mg O₃/L and a constant FeCl₃ addition of 2 mg Fe³⁺/L (Figure 26a, Colour 436₀: 1.72/m) and 6 mg Fe³⁺/L (Figure 26b, Colour 436₀: 1.65/m), respectively

3.1.10 Dissolved Chemical Oxygen Demand (COD_f)

COD_f of Ruhleben effluent was approximately 30.1 ± 2.1 mg/L during this project. Determination of COD_f was always a single value as this measurement is relatively time extensive. COD_{f,0} in trial series UF I-C (Figure 27a) was 30.2 mg/L and in trial series UF II-A (Figure 27b) 30.1 mg/L. Coagulation lead to a constant decrease in COD_f (Figure 27). The maximum reduction of COD_f was achieved with a treatment combination of 6 mg Fe³⁺/L and 10 mg O₃/L (Figure 27a) yielding in a relative COD_f of 85 %, corresponding to a concentration of 25.7 mg/L, whereas the samples treated without pre-ozonation but also coagulated with 6 mg Fe³⁺/L had a COD_f of 28.0 mg/L. This corresponds to a slightly higher relative COD_f of 93 %.

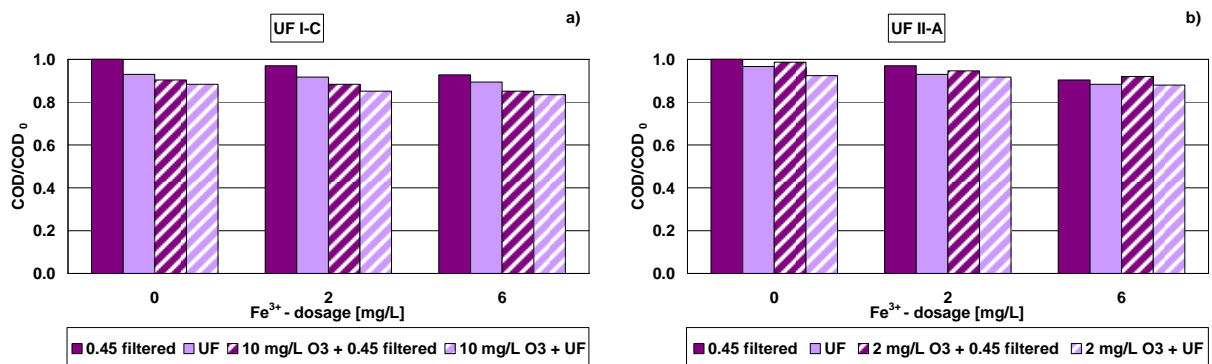

Figure 27: Relative COD_f for different coagulant dosages of 0-6 mg Fe³⁺/L with and without pre-ozonation (Figure 27a: 2 mg O₃/L, COD_{f,0}: 30.2 mg/L; Figure 27b: 10 mg O₃/L, COD_{f,0}: 30.1 mg/L)

The effect of pre-ozonation, especially with high dosages of 10 mg O₃/L, can be observed in Figure 28. Compared to the initial relative COD_f of the coagulated sample (Figure 28a and b), application of 10 mg O₃/L lead to an additional reduction of 7 % (10 mg O₃/L) and 5 % (2 mg O₃/L), respectively, corresponding to final COD_f concentrations of 25.3 mg/L and 25.0 mg/L, respectively. Total reduction of COD_f amounts to 9 % (10 mg O₃/L and 2 mg Fe³⁺/L) and 14 % (10 mg O₃/L and 6 mg Fe³⁺/L), respectively.

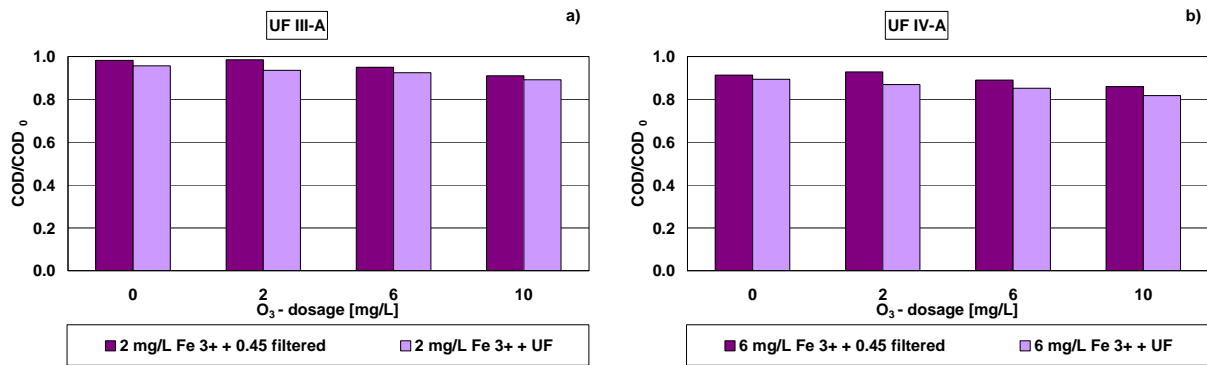

Figure 28: Relative COD_f for different ozone dosages of 0-10 mg O₃/L and a constant FeCl₃ addition of 2 mg Fe³⁺/L (Figure 28a, COD_{f,0}: 27.8 mg/L) and 6 mg Fe³⁺/L (Figure 28b, COD_{f,0}: 29.1 mg/L), respectively

3.2 Microfiltration (MF) tests

Figure 29 to Figure 31 show results of the microfiltration (MF) tests (0.2 μm pore size). Coagulation was always conducted with 4 mg Fe^{3+}/L . The only pre-ozonated sample shown in Figure 30 was prepared using 6 mg O_3/L . The first experimental trials were conducted with a pressure of 0.2 bar and resulted in an immediate flux decline of 91 % and 93 %, respectively after 100 ml of generated permeate dependent on pre-treatment (Figure 29). Due to these high flux decreases pressure was fixed at 0.5 bar during the second trial. Flux decline curves of this trial are displayed in Figure 30.

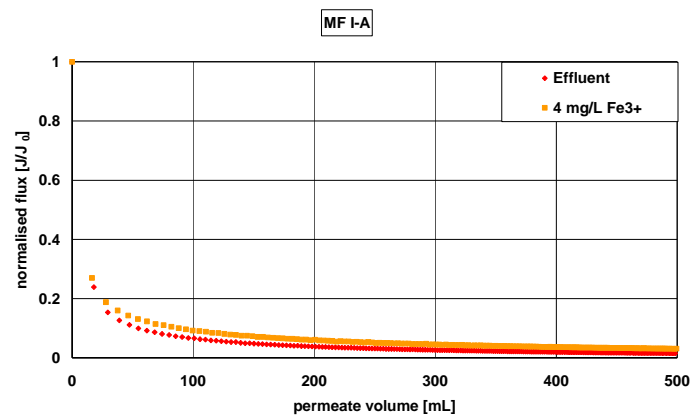

Figure 29: Flux decline curves for different coagulant concentrations of 0 and 4 mg Fe^{3+}/L with an applied pressure of 0.2 bar

The increased pressure seemed to improve the flux of the MF-membrane as after 100 ml of generated permeate flux decline of the untreated Ruhleben effluent and the coagulated sample was diminished to approximately 89 %. These findings were independent of pre-treatment as the increase in flux due to coagulation was negligible. Flux of the pre-ozonated sample increased slightly slower as after 100 ml of generated permeate flux decreased by 87 %.

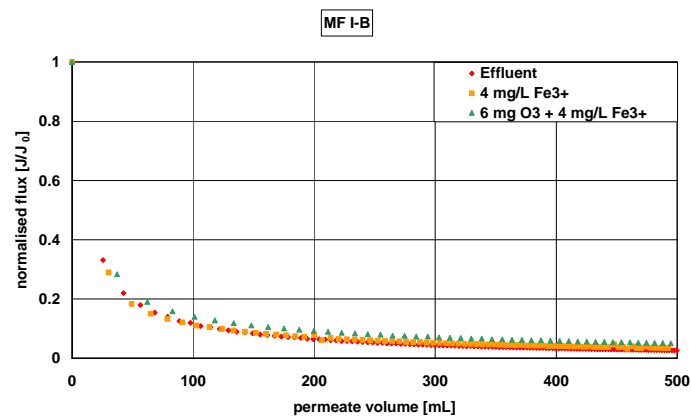

Figure 30: Flux decline curves for different ozone dosages of 0 and 6 mg O_3/L and coagulant concentrations of 0 and 4 mg Fe^{3+}/L with an applied pressure of 0.5 bar

During the third trial with an MF-membrane pressure was once again increased and amounted to 0.7 bar. Results of this trial are shown in Figure 31. No further increase in flux was

observed, as flux decreased and was approximately 7 % of the initial flux after filtration of 100 ml, comparable to the flux obtained with an applied pressure of 0.2 bar in Figure 29.

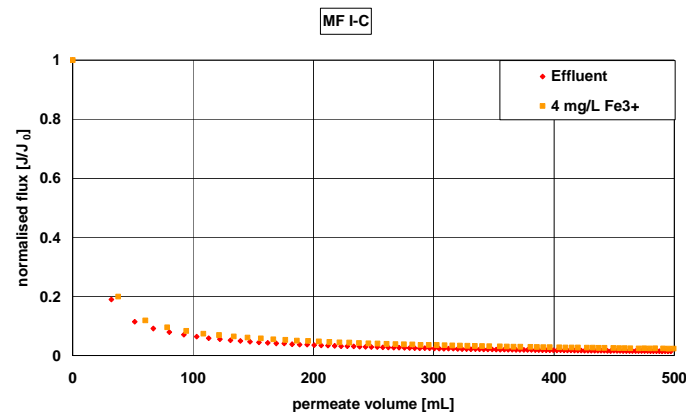

Figure 31: Flux decline curves for different coagulant concentrations of 0 and 4 mg Fe³⁺/L with an applied pressure of 0.7 bar

Independent on the applied pressure and pre-treatment, during generation of the first 100 ml permeate flux gradients show a major decrease of 87-93 %. Flux during MF trials was reduced to approximately 3 % of the initial normalised flux after producing 500 ml permeate independent on pre-treatment, whereas trials using an UF-membrane (chapter 3.1.1) resulted in 10 % (effluent without pre-treatment) to 30 % (10 mg O₃/L and 6 mg Fe³⁺/L) of the initial flux, depending on the different pre-treatment steps. This strong decrease in flux is likely caused by pore blocking of ferric colloids in the range of 0.2 µm due to the larger pore size of the MF-membrane of 0.2 µm compared to the pore size of 26 nm of the UF-membrane.

3.3 Backwash trials

In Figure 32 to Figure 34 flux decline curves and corresponding filtration times of the conducted BW trials are depicted. Each BW experiment was performed twice. As the results of corresponding BW experiments were analogue, only results of one experiment are shown. An overview of all obtained flux decline curves is given in the annex (chapter 6.2.2).

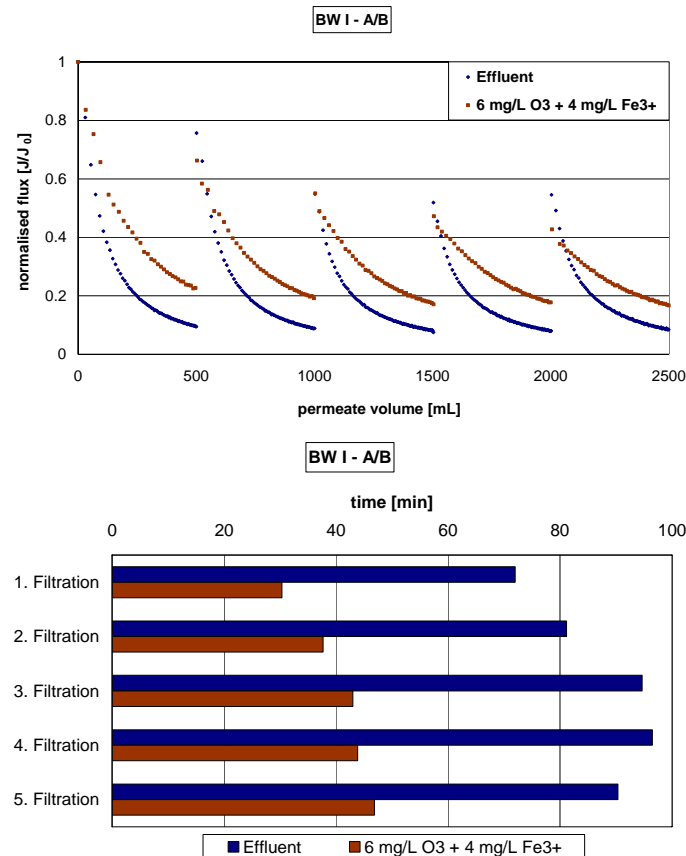

Figure 32: Flux decline curves of BW experiments and corresponding filtration times comparing untreated Ruhleben effluent and Ruhleben effluent pre-treated with 6 mg O₃/L and 4 mg Fe³⁺/L

Figure 32 displays flux decline curves and associated filtration times for the effluent without pre-treatment and the effluent treated with 6 mg O₃/L and 4 mg Fe³⁺/L. There are no significant differences in irreversible fouling visible. Flux decline curves of pre-treated samples are located above flux decline curves of the effluent without pre-treatment and flux at the end of each filtration cycle is always higher for pre-treated samples. This is also reflected in reduced filtration times of the treated effluent. Filtration of the effluent without pre-treatment took approximately twice as long as filtration of the treated effluent. Thus the formed filter cake layer on the membrane seems to be more porous as for the same amount of generated permeate less time is needed and higher fluxes are observed. For the effluent without pre-treatment flux is reduced to approximately 8 % of the initial flux, independent on the number of filtration cycles. In contrast flux of the treated effluent shows a decline in flux after each filtration cycle from 23 % to a minimum flux of 17 % after five filtration cycles. The first two filtration cycles cause similar main parts of irreversible fouling, as they reduce the initial flux by an average of 29 % (first filtration cycle) and 45 % (second filtration cycle), respectively, whereas irreversible fouling after four filtration cycles amounts to 45 % for the effluent and 57 % for the treated effluent. Reversible fouling is primarily caused by the first filtration cycle. After filtration of 500 ml effluent 76 % of the initial flux was restored by BW, whereas 66 % of the initial flux was recovered for the treated effluent. The percentage of reversible fouling caused by the first filtration cycle comes to 67 % for the effluent and 43 % for the treated effluent. Further filtration cycles lead to a nearly constant rate of reversible fouling of approximately 46 % for the effluent and 31 % for the ozonated and coagulated effluent. Filtration times reflect also the main fouling during the first two filtration cycles, as

filtration time of the effluent without pre-treatment increases from 72 minutes (first cycle) to 81 minutes (second cycle). Average time needed for the third, fourth and fifth filtration cycle is 94 minutes. An increase in filtration time from 30 minutes to 38 minutes to an average time of 45 minutes is observed for the treated effluent. Average reduction in filtration time during the first and second cycle amounts to 42 minutes, whereas time needed for filtration of 500 ml sample declined by an average of 49 minutes during filtration cycle 3 to filtration cycle 5.

Flux decline curves for the coagulated effluent (4 mg Fe³⁺/L) and the corresponding pre-ozonated sample are shown in Figure 33. The fraction of irreversible fouling decreases significantly with the application of 4 mg Fe³⁺/L compared to the effluent without pre-treatment in Figure 32 and comes to a maximum of only 22 % after the fifth filtration cycle. Application of 6 mg O₃/L and 4 mg Fe³⁺/L results in flux decline curves comparable to those depicted in Figure 32, which originate from a different trial day. Therefore irreversible fouling amounts to a similar maximum of 51 % after the fourth filtration cycle. Comparing directly samples with a coagulant concentration of 4 mg Fe³⁺/L with and without pre-ozonation shows that application of 6 mg O₃/L results in a clear increase of irreversible fouling. Analogue to these findings the percentage of reversible fouling decreases after pre-ozonation. Average flux of the coagulated sample at the end of each filtration cycle is constant and amounts to 16 %, whereas flux of the pre-ozonated and coagulated sample decreases from 21 % after the first cycle ad 19 % after the second cycle to 17 % after cycle 3 to cycle 5. It is obvious that pre-ozonation changes characteristics of foulants as after the application of ozone irreversible fouling increases significantly. In contrast this intense increase in irreversible fouling due to pre-ozonation resulting in a lower initial flux after BW, filtration times are reduced. During the first and second filtration cycle time needed for filtration of 500 ml sample is reduced by 14 and 7 minutes, respectively. Filtration times for cycle 3 to cycle 5 are nearly constant. Pre-ozonated samples needed only approximately 2 minutes less time.

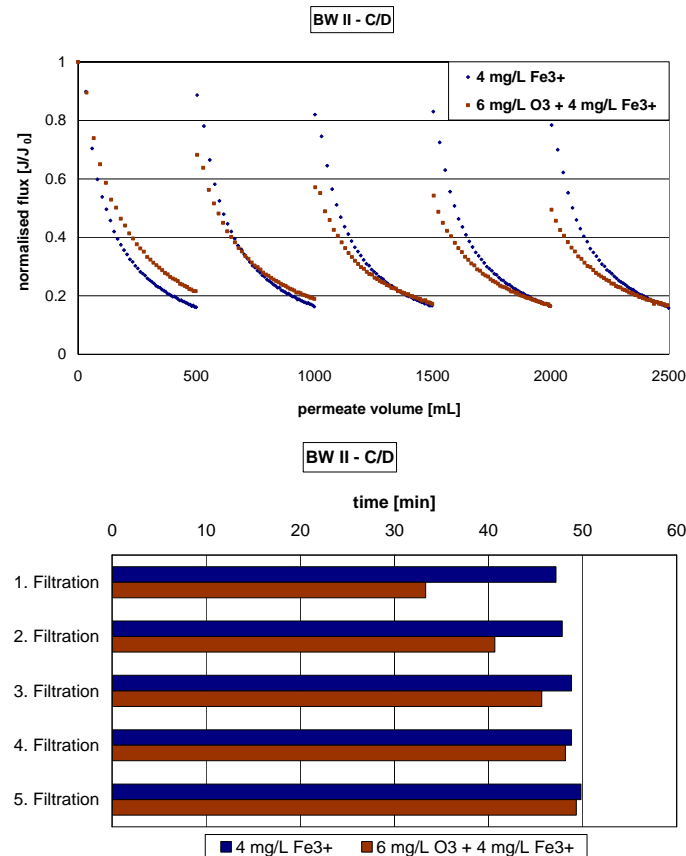

Figure 33: Flux decline curves of BW experiments and corresponding filtration times comparing coagulated Ruhleben effluent (4 mg Fe³⁺/L) and Ruhleben effluent pre-treated with 6 mg O₃/L and 4 mg Fe³⁺/L

In order to specify the influence of pre-ozonation on flux decline and fouling experiments with a constant coagulant concentration of 4 mg Fe³⁺/L and an increasing ozone dosage of 0-10 mg O₃/L were conducted. Results of these experiments are shown in Figure 34. Consistent with previous results pre-ozonation increased irreversible fouling. This effect amplifies with increasing ozone dosage. Application of 2 mg O₃/L leads only to a slightly lower initial flux after BW of approximately 2 % compared to the coagulated sample without pre-ozonation. High ozone dosages of 6 and 10 mg O₃/L result in significantly lower initial fluxes. Comparing the initial flux of the coagulated sample with the initial flux of the samples pre-ozonated with 6 mg O₃/L and 10 mg O₃/L, the difference in initial flux at the beginning of each new filtration cycle is constant and amounts to 21 % and 36 %, respectively. Thus, the increase in irreversible fouling for pre-ozonated samples derives only from the first filtration cycle. At the beginning of the fifth filtration cycle minimum initial fluxes of 51 % (6 mg O₃/L) and 39 % (10 mg O₃/L) are reached. Flux decline curves flatten with increasing pre-ozonation dosage as irreversible fouling increases. Thus, flux at the end of each filtration cycle decreases for high ozone dosages from 27 % after filtration of 500 ml to 21 % after filtration of 2500 ml with the application of 6 mg O₃/L and from 25 % to 20 % applying 10 mg O₃/L. In contrast samples pre-treated with low ozone dosages and samples without pre-treatment showed an average flux at the end of each filtration cycle of 18 % (0 mg O₃/L) and 22 % (2 mg O₃/L). For these trials a diagram of filtration times does not deliver more information, as initial pure water fluxes of the used membranes varied too much. Flux decline curves are related to different initial pure water fluxes. Filtration times do not include the

different fluxes of pure water that have a strong influence on the time needed for filtration of 500 ml sample.

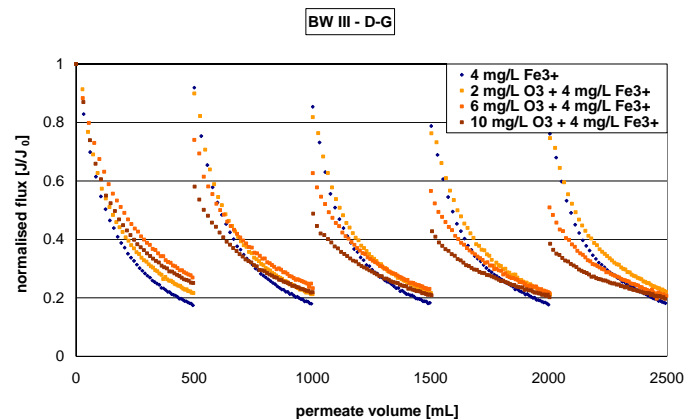

Figure 34: Flux decline curves of BW experiments comparing coagulated Ruhleben effluent and Ruhleben effluent pre-treated with 2, 6 or 10 mg O₃/L and 4 mg Fe³⁺/L

LC-OCD analysis from the effluent, treated effluent, permeate after 1st, 3rd and 5th cycle and from the BW water, withdrawn after every 1st, 3rd and 5th cycle seemed promising for obtaining more information of the reasons of fouling. As these data are inconsistent, they are only shown in the annex (chapter 6.2.4). Severe problems during sample extraction could derive from the flocs, that detach during BW from the membrane and are therefore contained in the BW water. As samples for LC-OCD analysis have to be pre-filtered by a 0.45 µm filter, these flocs accumulate on the filter and form a filter cake layer that retains more BP. The amount of flocs depends on sample drawing and thus fluctuates to a great extent. An alternative option could be a fractionation of the BW water by centrifugation. After separation of the iron flocs the adsorbed fraction of organics and the dissolved fraction of the supernatant could be analysed separately by LC-OCD.

Conclusion:

- ⇒ Irreversible fouling decreases significantly with application of coagulant (4 mg Fe³⁺/L) compared to the effluent without pre-treatment from 45 % to 22 % after 4 filtration cycles.
- ⇒ The first two filtration cycles cause main parts of irreversible fouling.
- ⇒ Pre-ozonation changes characteristics of foulants as especially high ozone dosages of 6 and 10 mg O₃/L result in a clear increase of irreversible fouling (21 % and 36 %, respectively), which is caused during the first filtration cycle.
- ⇒ Despite of the increase in irreversible fouling comparing samples coagulated with 4 mg Fe³⁺/L and samples treated with a combination of 6 mg O₃/L and 4 mg Fe³⁺/L filtration times of pre-ozonated samples are reduced by 30 % and 15 % during the first and second filtration cycle compared to the coagulated samples without pre-ozonation.
- ⇒ At the end of the first filtration cycle fluxes of samples pre-treated with ozone and coagulant are always higher as for the coagulated sample (up to 10 %), whereas flux after five filtration cycles is nearly the same for samples with and without pre-ozonation.

4 Conclusion and Perspective

The tested pre-treatment on Ruhleben effluent of pre-ozonation and subsequent coagulation enables good phosphorus removal with permeate concentrations of 25 to 50 µg P/L that are independent of pre-ozonation. Coagulation with 2 mg Fe³⁺/L leads to P_{T,f} concentrations < 60 µg P/L, whereas application of 6 mg Fe³⁺/L reduces P_{T,f} to concentrations < 50 µg P/L. In filtration tests with new membrane material pre-ozonation without coagulation leads to a less distinct flux decline of approximately 3 %. Coagulation without pre-ozonation increases the flux by 10 - 13 % (end of filtration) and reduces the filtration time by 33 - 40 % depending on the coagulant concentration. The combination of both pre-treatment steps applying 10 mg O₃/L and 6 mg Fe³⁺/L improves the filtration performance compared to the effluent without pre-treatment up to 20 % and reduces the filtration time for 500 mL by 61 %. Combining high ozone dosages (10 mg O₃/L) and low coagulant concentrations of 2 mg Fe³⁺/L increases the flux still by 15 % and leads to a reduction in filtration time of 51 % compared to effluent without pre-treatment. Thus, the synergetic effect deriving from a combination of pre-ozonation and coagulation increases with the concentration of the applied coagulant. Synergetic effects of low ozone dosages of 2 mg O₃/L are hardly visible.

The amount of BP correlates with flux decline. Different mechanisms are considered as reasons for the improved performance after pre-ozonation and subsequent coagulation. It is known that coagulation partially removes the fouling-active BP and humic substances. This effect increases with increasing coagulant concentration. The pre-treatment with ozone, even at low dosages (2 mg O₃/L), leads to a significant decrease of UVA 254, pointing on a shift to more polar molecules and reduces Colour 436 significantly. An increase in ozone dosage decreases the amount of BP eluting with the main peak around 38 minutes. This effect is more pronounced with low coagulant concentrations. Higher ozone dosages (> 6 mg/L) additionally seem to induce disintegration of BP and a shift to smaller organic compounds. The observed changes in the amount of BP and in elution times could also derive from a change in the detectable amount of BP due to pre-ozonation.

The interaction between ozonation and coagulation leads to a colloidal stabilisation of iron in solution. As a consequence, less iron is provided for the coagulation process. Thus, the synergetic effect of pre-ozonation and coagulation on the filtration performance increases with increasing iron dosage, as the percentage of stabilised colloidal iron in solution decreases with increasing iron dosage.

A clear impact of the microfloculation effect is not visible as results of turbidity < 1 µm measurements do not show a distinct effect on flux decline. In order to exclude the particle fraction of 450-1000 nm that also contributes to an unknown extent to turbidity measurements, further research with a filter of a pore size of approximately 450 nm seems reasonable. Thus only colloids in the range of 10-450 nm, which were identified as main foulants during UF, would be measured and a possible correlation could be shown. Hence, prediction of flux decline by turbidity measurement might be possible.

Concentrations of dissolved COD can be reduced by a combination of pre-ozonation and coagulation of up to 15 %, depending on the ozone dosage.

The conducted BW trials revealed that main parts of irreversible fouling were caused during the first two filtration cycles. Furthermore a clear increase of irreversible fouling due to pre-ozonation is observed after the first filtration cycle especially with high ozone dosages of 6 and 10 mg O₃/L. Thus, pre-ozonation seems to change characteristics of the foulants. In spite of the increase in irreversible fouling, filtration times of pre-ozonated samples are reduced by 30 % and 15 % for the first and second filtration cycle compared to corresponding samples, pre-treated only with coagulation. After the first filtration cycle the flux of samples without pre-ozonation is always lower than flux of samples pre-treated with ozone. At the end of five filtration cycles this effect is no more visible, as flux is nearly the same for all samples, independent on pre-ozonation, although initial flux was lower. One possible option for the increased irreversible fouling after pre-ozonation might be an increase of in-pore adsorption of disintegrated BP fragments.

These results suggest that combining pre-ozonation and coagulation is a promising pre-treatment process to reduce the fouling of organic membranes, without the necessity of applying free dissolved ozone onto the membrane surface. Concerning the problems of increased irreversible fouling after pre-ozonation it has to be considered, that BW conducted in these test trials differs from BW procedures at pilot plants. Beyond these differences in BW, Zheng (2010) found that high filtration pressures of approximately 1 bar result in more compact BP fouling which is more difficult to be hydraulically backwashed. Zheng (2010) showed an increase in irreversible fouling from 22 % to 30 % with an increase in filtration pressure from 0.8 to 1.0 bar, whereas filtration pressure of 0.6 and 0.4 bar only result in 19 % and 18 % irreversible fouling. This influence of filtration pressure on irreversible fouling was also confirmed by pilot-scale UF experiments. Furthermore only one type of PES UF-membrane with a MWCO of 150 kDa was tested. Possibly different UF-membranes differ in intensity of irreversible fouling and therefore more research is needed.

Conclusion:

- ⇒ Coagulation increases flux (10 % - 13 %) and minimizes filtration time (33 % - 40 %).
- ⇒ Pre-ozonation (10 mg O₃/L) leads to an additional maximum flux increase of 6 %.
- ⇒ Filtration time of the effluent without pre-treatment (coagulated effluent) is reduced by 50 % - 60 % (28 % - 33 %) with the combination of pre-ozonation and coagulation.
- ⇒ Benefits (maximal flux increase of 20 %) combining pre-ozonation (6 - 10 mg O₃/L) and coagulation increases with coagulant concentration.
- ⇒ Independent on pre-ozonation Total Soluble Phosphorus (P_{T,f}) is reduced to concentrations < 50 µg P/L by coagulation (4 and 6 mg Fe³⁺/L).
- ⇒ Coagulation and pre-ozonation have a positive effect on biopolymer removal and therefore lead to reduced membrane fouling.
- ⇒ High ozone dosages result in disintegration of biopolymers.
- ⇒ Mainly high ozone dosages lead to a complexation of iron and therefore increased residual iron.
- ⇒ Irreversible fouling is primarily caused by the first two filtration cycles.
- ⇒ Pre-ozonation increases irreversible fouling and the benefit in reduced filtration times is only visible for the first two filtration cycles.

5 References

- Bahr, C., Ernst, M. und Jekel, M. (2007): PILOTOX - Pilotuntersuchungen zur kombinierten oxidativ-biologischen Behandlung von Klärwerksabläufen für die Entfernung von organischen Spuren- und Wirkstoffen und zur Desinfektion. Schriftenreihe Kompetenzzentrum Wasser Berlin. Band 5. Berlin.
- DVGW (1998): Flockung in der Wasseraufbereitung; Teil 2: Flockungstestverfahren (Arbeitsblatt W 218). Wirtschafts- und Verlagsgesellschaft Gas und Wasser mbH. Bonn.
- EU-Wasserrahmenrichtlinie (2000): Richtlinie 2000/60/EG des Europäischen Parlaments und des Rates vom 23. Oktober 2000 zur Schaffung eines Ordnungsrahmens für Maßnahmen der Gemeinschaft im Bereich der Wasserpolitik.
- Gnirß, R. (2008): Membranfiltration in Berlin. Wasserwirtschaft Wassertechnik - wwt 2008 (7-8). 10-15.
- Jekel, M. (1998): Effects and mechanisms involved in preoxidation and particle separation processes. *Water Science and Technology* 37 (10). 1-7.
- Jermann, D., Pronk, W., Boller, M. (2008): Mutual Influences between Natural Organic Matter and Inorganic Particles and Their Combined Effect on Ultrafiltration Membrane Fouling. *Environmental Science and Technology* 42 (24). 9129-9136.
- Laabs, C. (2004): Fouling of low-pressure membranes by municipal wastewater: identification of principal foulants and underlying fouling mechanisms. Dissertation. Fachgebiet Wasserreinhaltung. Technische Universität Berlin.
- Senatsverwaltung für Stadtentwicklung (Ed.) (2001): Abwasserbeseitigungsplan Berlin. 1. Auflage. Berlin 2001.
- Te Poele, S. (2006): Foulants in ultrafiltration of wwtp effluent. Dissertation. Technische Universität Delft.
- Zheng, X. (2010): Major Organic Foulants in Ultrafiltration of Treated Domestic Wastewater and Their Removal by Bio-filtration as Pre-treatment. Dissertation. Fachgebiet Wasserreinhaltung. Technische Universität Berlin.
- Zheng, X; Ernst, M; Jekel, M. (2009): Identification and quantification of major organic foulants in treated domestic wastewater affecting filterability in dead-end ultrafiltration. *Water Research* 43 (1). 238-244.

6 Annex

6.1 Calculation of the pressure needed for MF filtration tests

Measured permeate flowrate at the beginning was approximately 35 ml/min. The effective membrane filtration area was $28.7 \text{ cm}^2 = 0.00287 \text{ m}^2$. Hence, flux during UF trials can be calculated as shown in Equation 2.

$$Flux_{UF} = \frac{0.035 \cdot 60 \text{ L/h}}{0.00287 \text{ m}^2} = 731.7 \text{ L/h} \cdot \text{m}^2 \quad \text{Equation 2}$$

Flux for the MF-membrane was declared with $> 1500 \text{ ml/m}^2 \cdot \text{h}$ at 0.7 bar. Equation 3 displays the calculation of the permeability of the MF-membrane.

$$permeability_{MF} = \frac{1500 \text{ L/m}^2 \cdot \text{h}}{0.7 \text{ bar}} = 2142.9 \text{ L/m}^2 \cdot \text{h} \cdot \text{bar} \quad \text{Equation 3}$$

The measured permeate flowrate of the UF-membrane divided by the permeability of the MF-membrane (Equation 4) delivers the theoretical flux needed to obtain an comparable permeate flow rate for the MF trials.

$$\frac{731.7 \text{ L/h} \cdot \text{m}^2}{2142.9 \text{ L/m}^2 \cdot \text{h} \cdot \text{bar}} = 0.34 \text{ bar} \quad \text{Equation 4}$$

The determined pressure for the MF experiments was 0.34 bar. As the declaration in the data sheet for the MF-membrane for the flux was $> 1500 \text{ L/m}^2 \cdot \text{h}$ the calculated pressure would decrease with increasing flux of the MF-membrane. Therefore it was decided to start with a pressure of 0.2 bar.

6.2 Diagrams

6.2.1 Ozonation

Table 6: Overview of results of UF trials – Ozonation of Ruhleben secondary treated effluent with different combinations of Fe^{3+} -concentrations (0 - 6 mg Fe/L) and ozone dosages (0-10 mg O_3 /L) – overview of results of UF trials

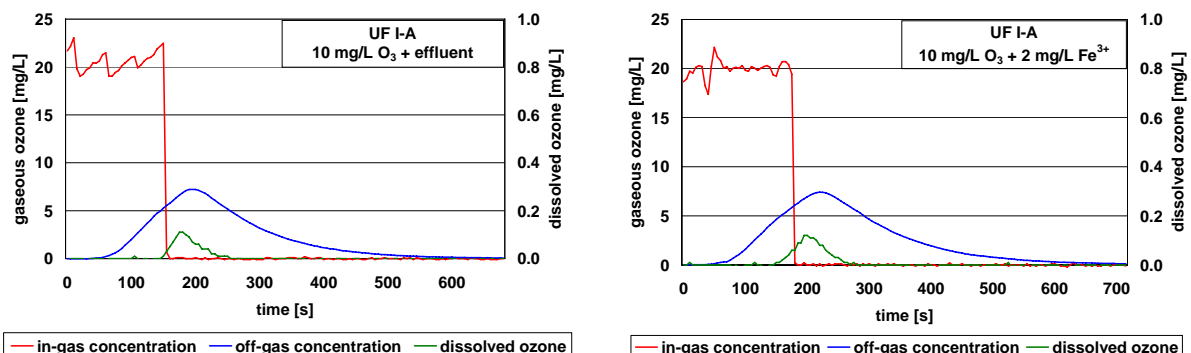

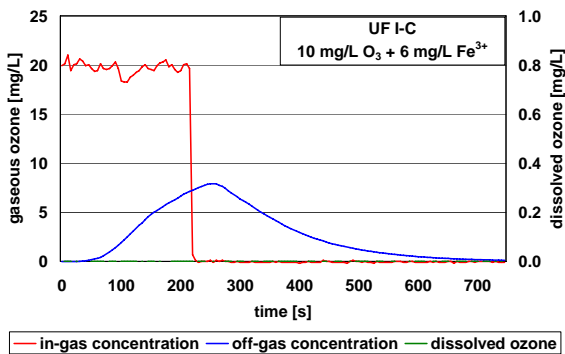
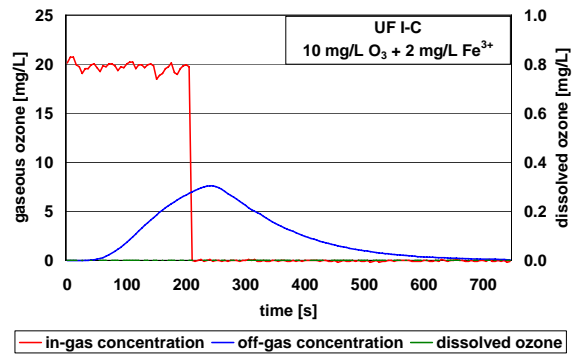
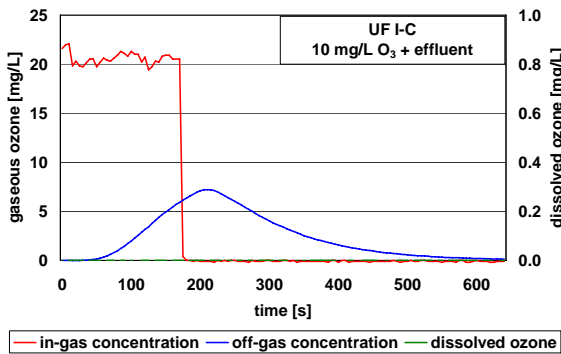
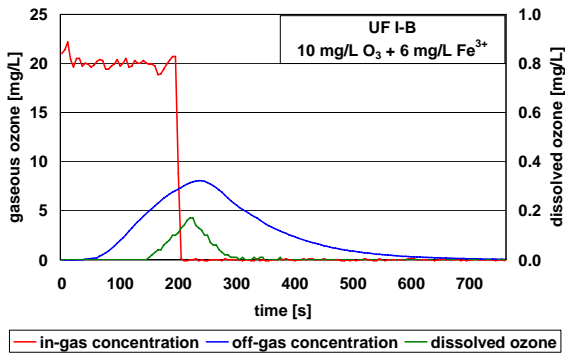
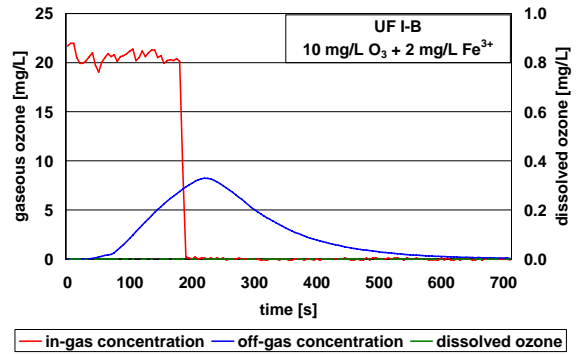
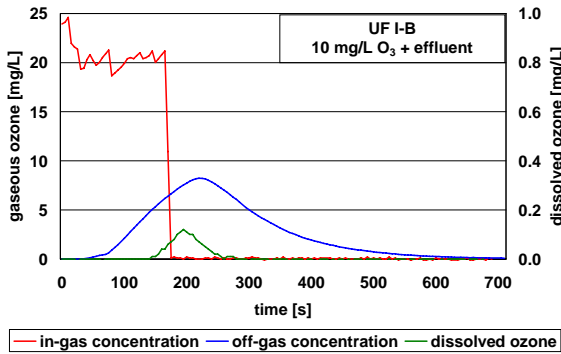
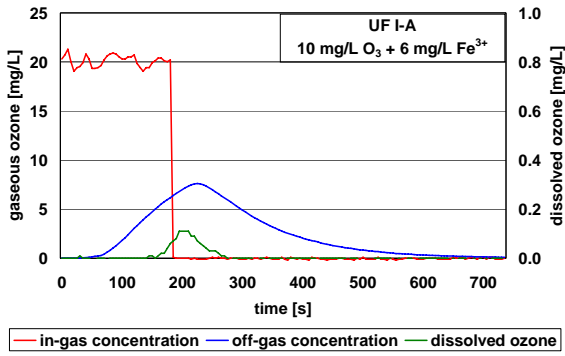

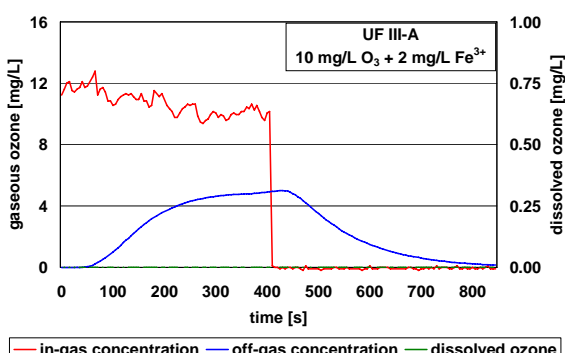
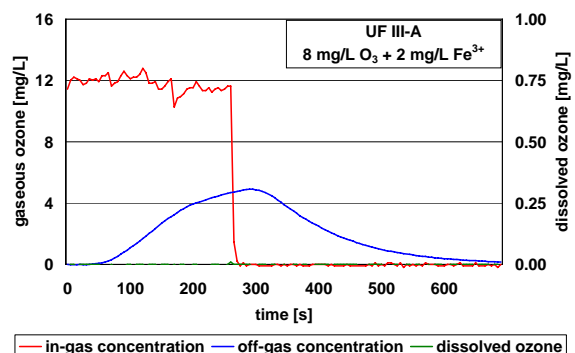
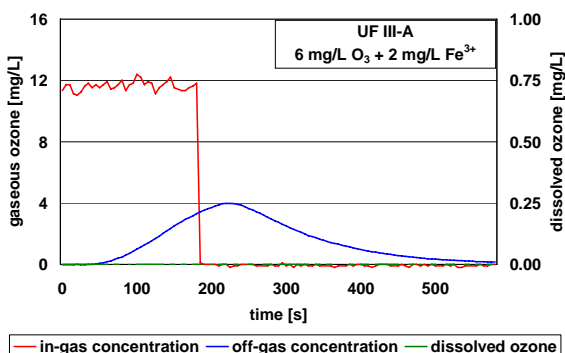
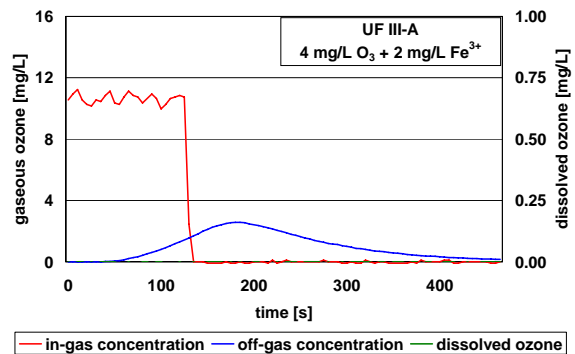
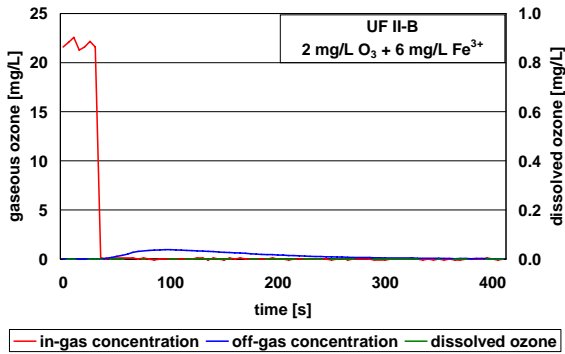
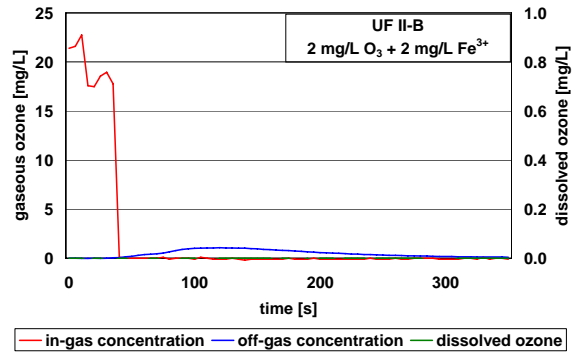
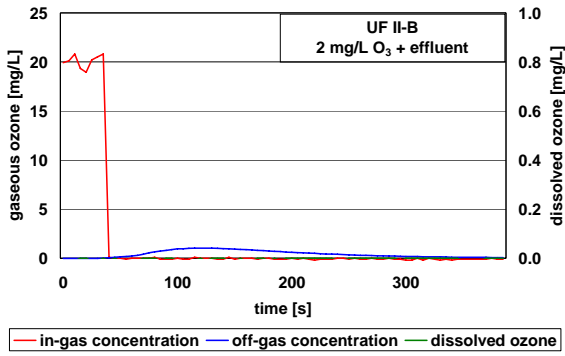

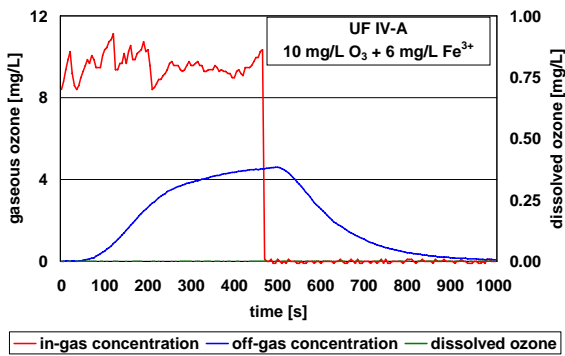
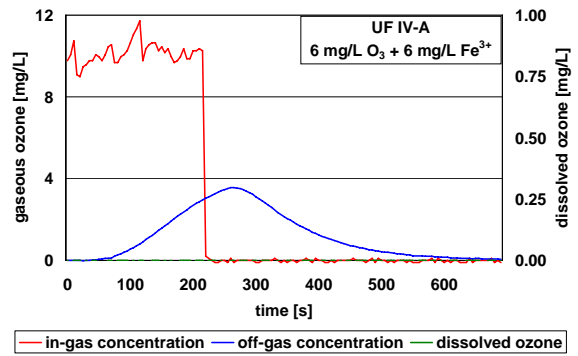
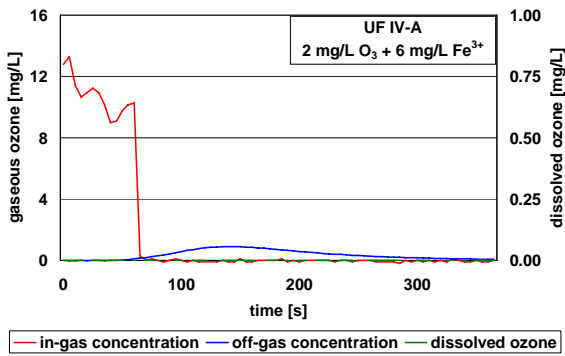
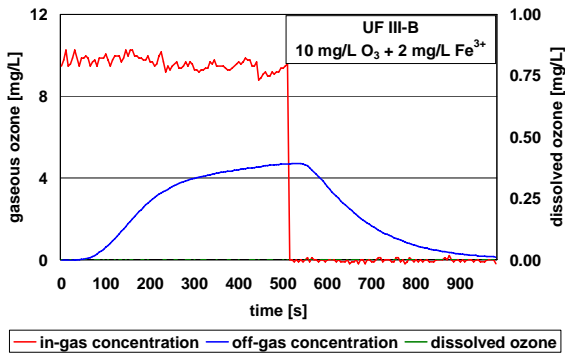
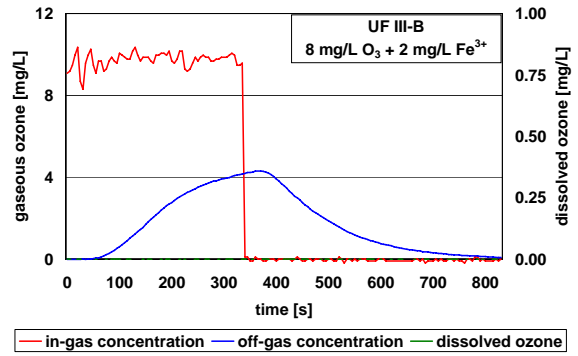
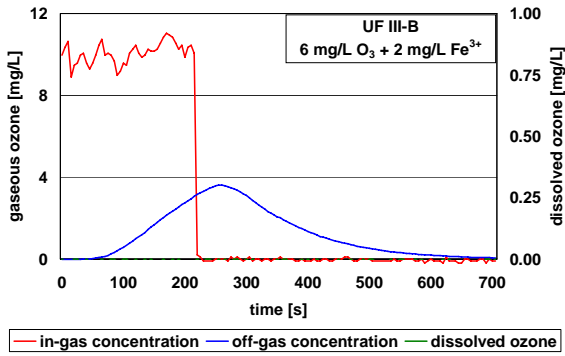
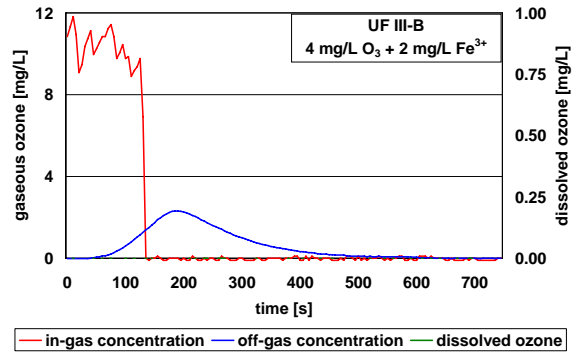
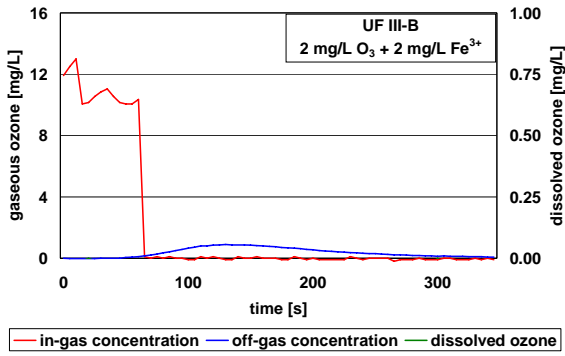

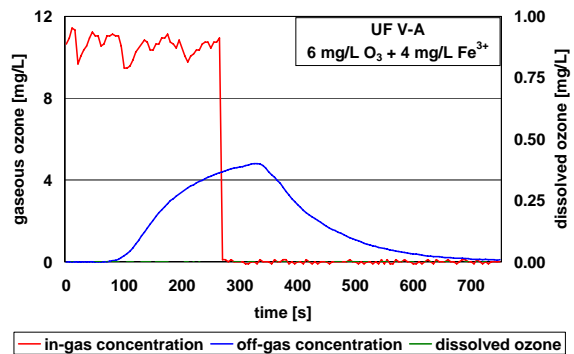
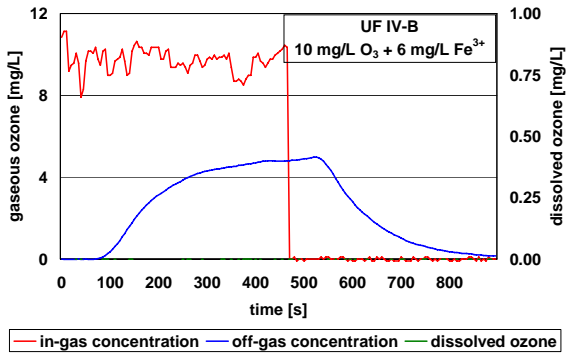
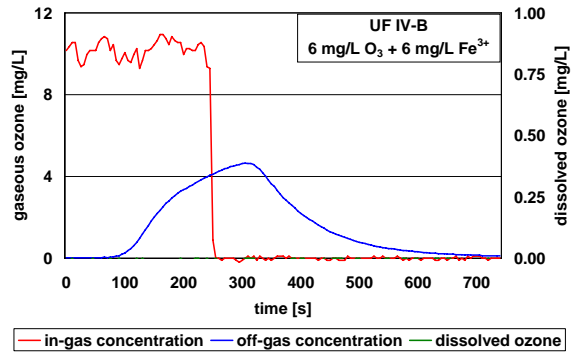
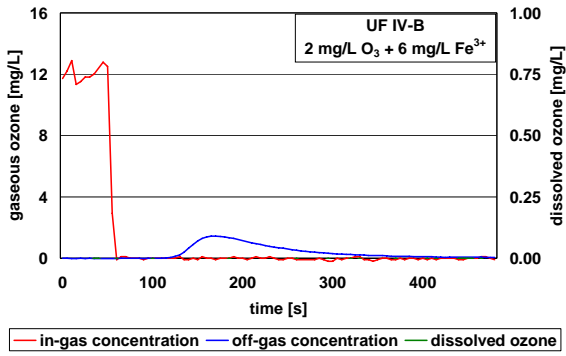

6.2.2 Flux decline

Table 7: Overview of results of UF trials – Flux decline curves of Ruhleben secondary treated effluent with different combinations of Fe³⁺-concentrations (0 - 6 mg Fe/L) and ozone dosages (0-10 mg O₃/L)

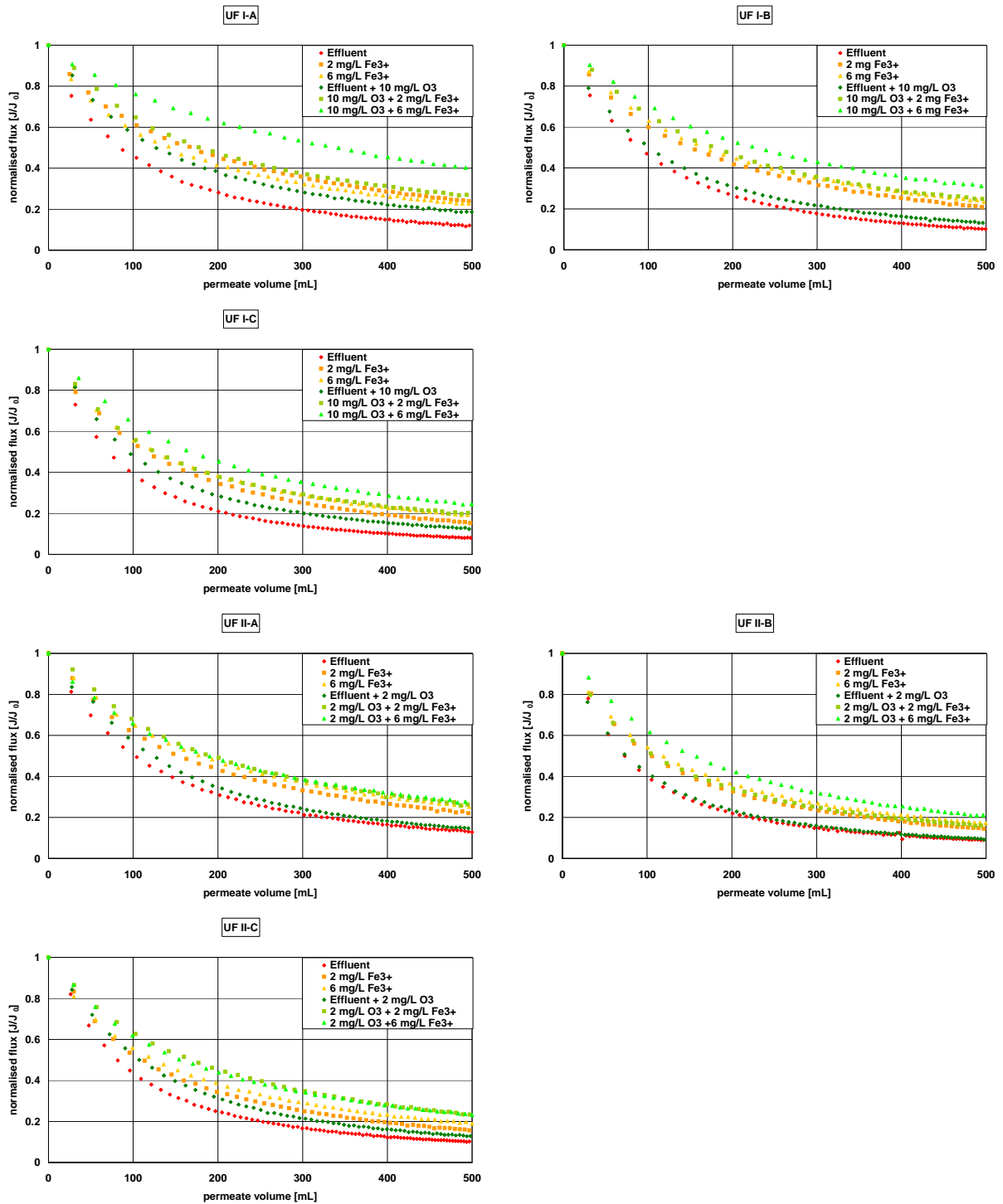

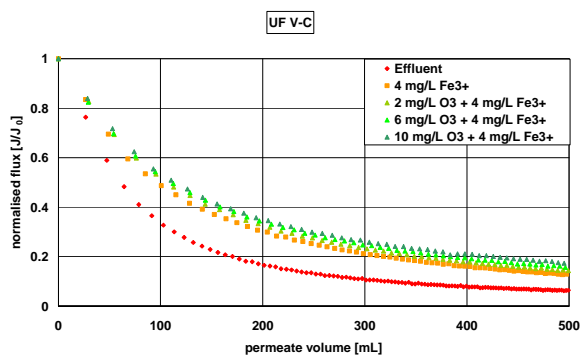
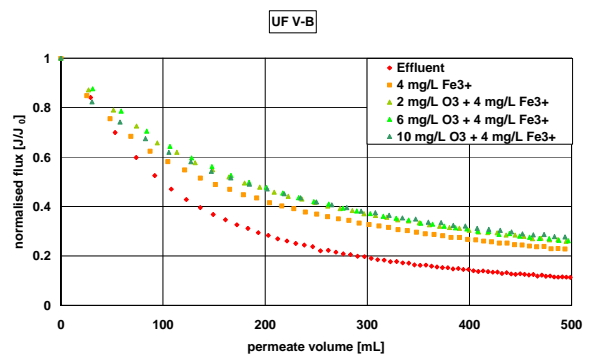
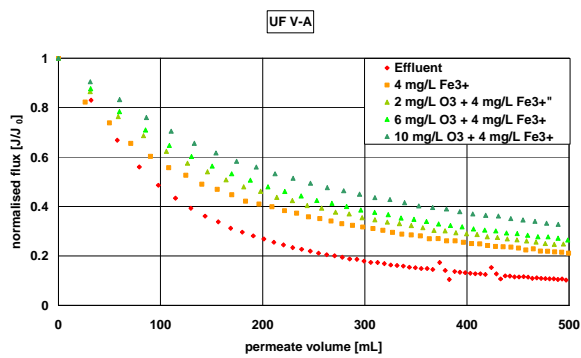
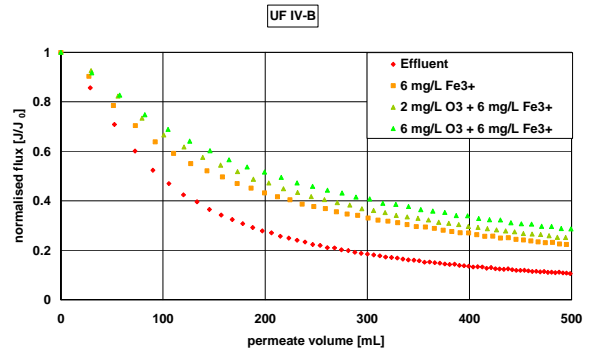
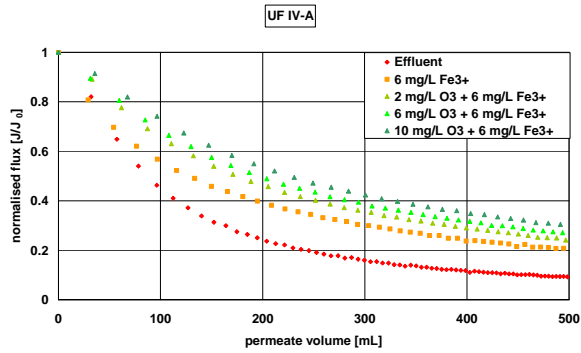
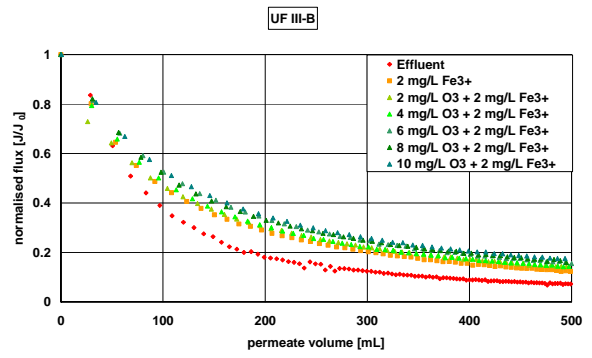
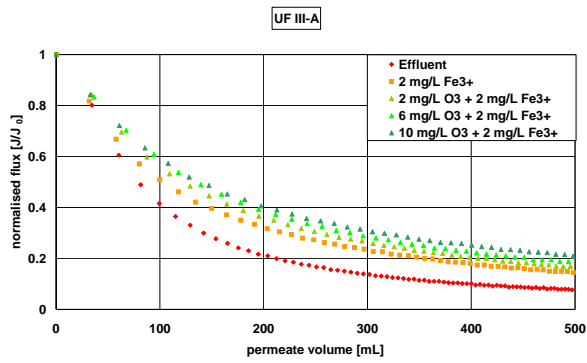
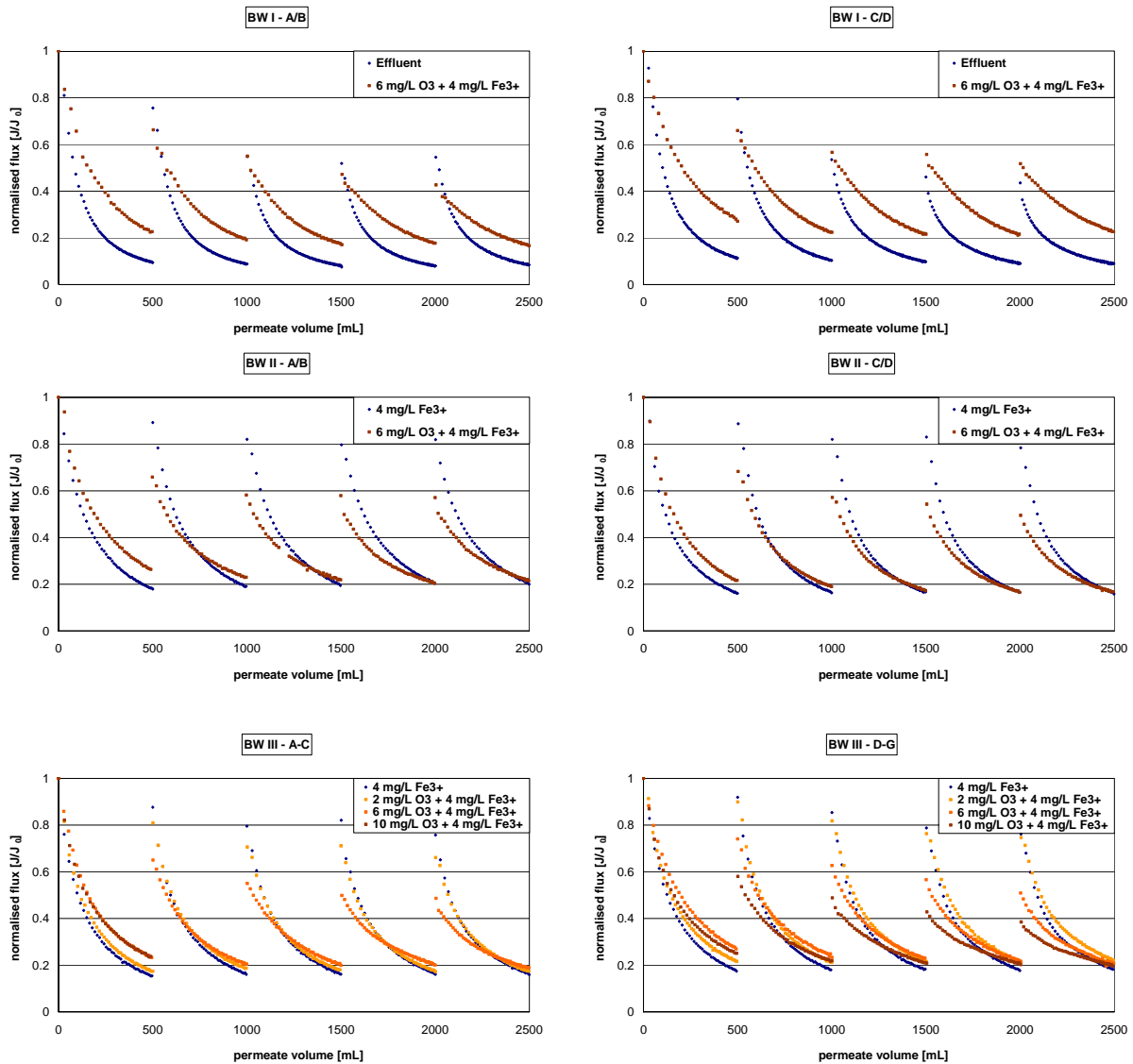
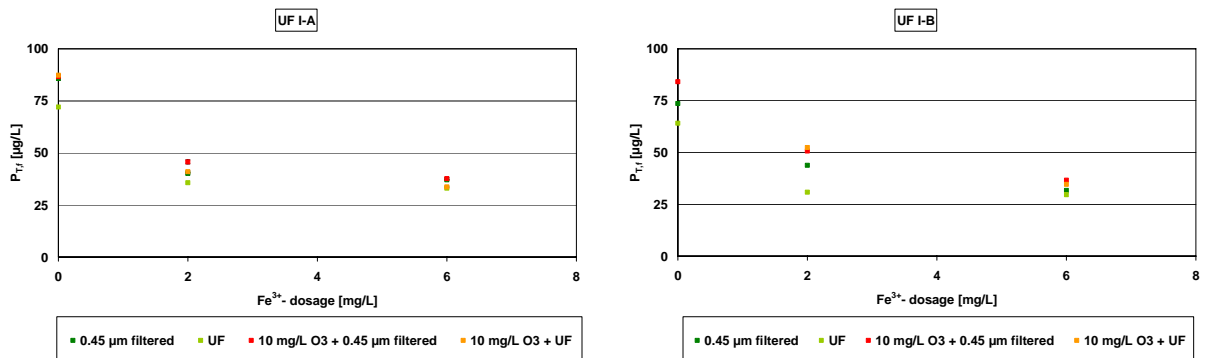

Table 8: Overview of results of BW trials – Flux decline curves of untreated Ruhleben secondary effluent and Ruhleben secondary effluent with 4 mg Fe³⁺/L and different ozone dosages (0-10 mg O₃/L)



6.2.3 Total Soluble Phosphorus (P_{T,f})

Table 9: Overview of results of UF trials – P_{T,f} of Ruhleben secondary treated effluent with different combinations of Fe³⁺-concentrations (0 - 6 mg Fe/L) and ozone dosages (0-10 mg O₃/L)



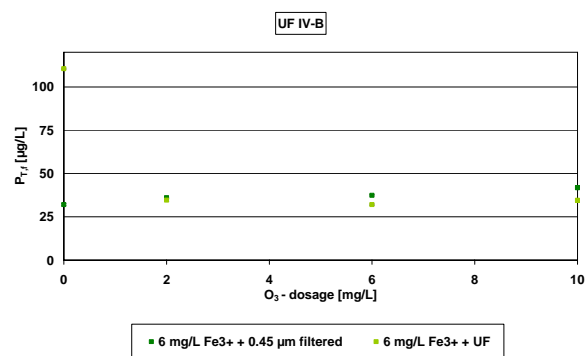
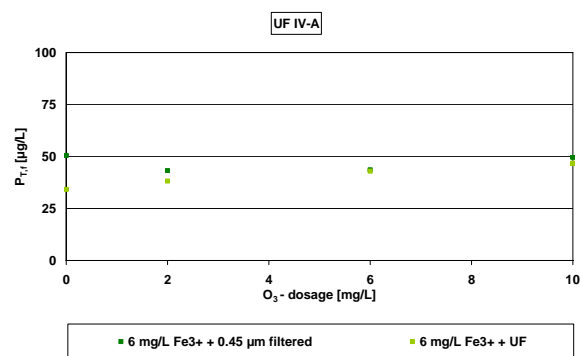
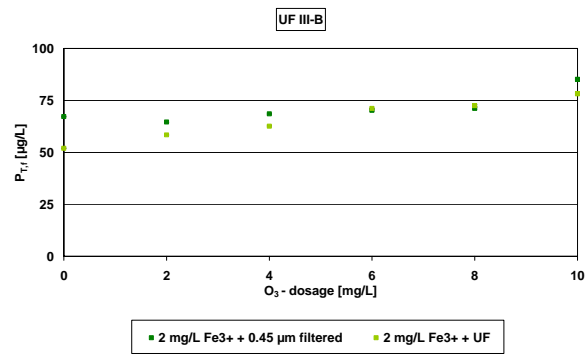
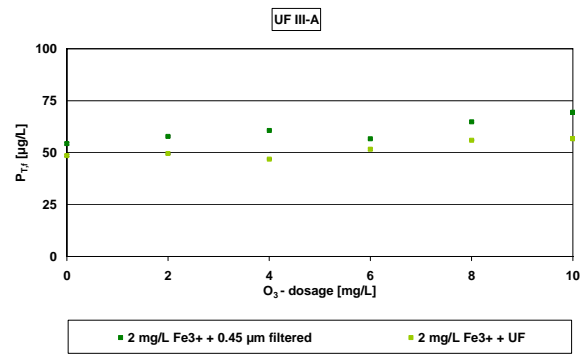
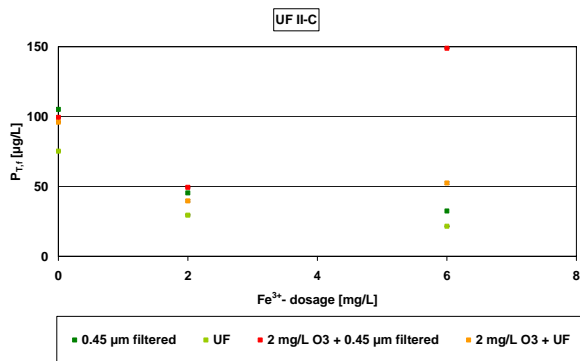
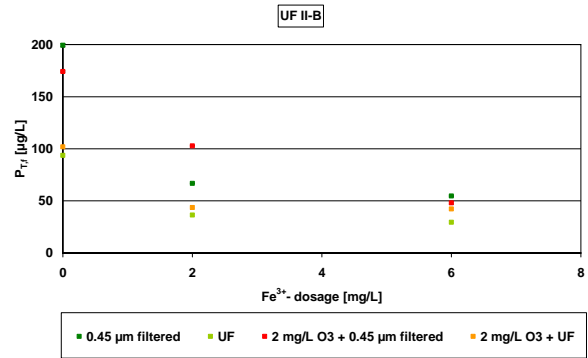
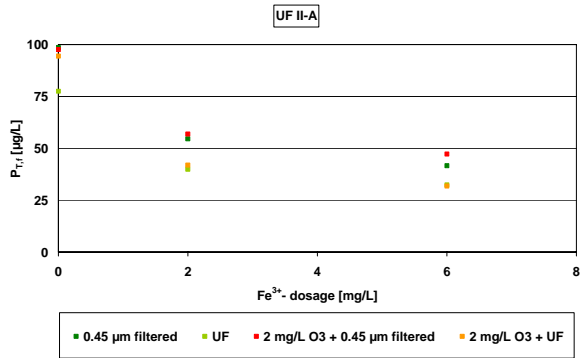
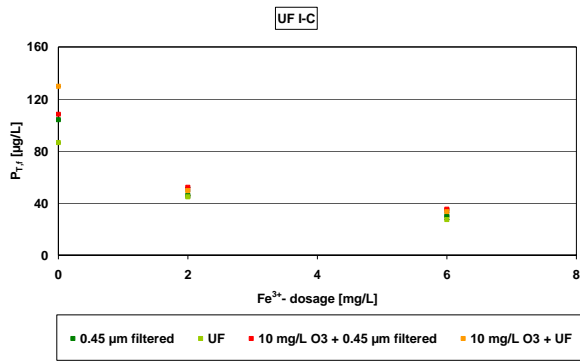

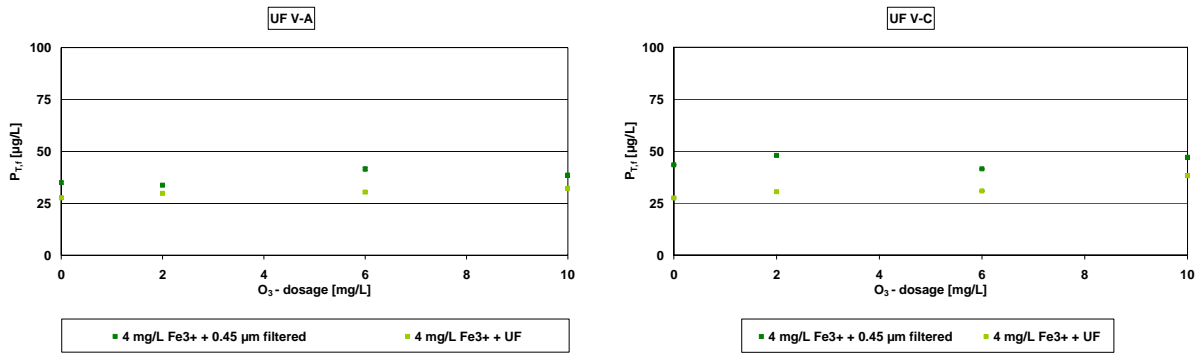

Table 10: Overview of results of BW trials – P_{T,F} of untreated Ruhleben secondary effluent and Ruhleben secondary effluent with 4 mg Fe³⁺/L and different ozone dosages (0-10 mg O₃/L)

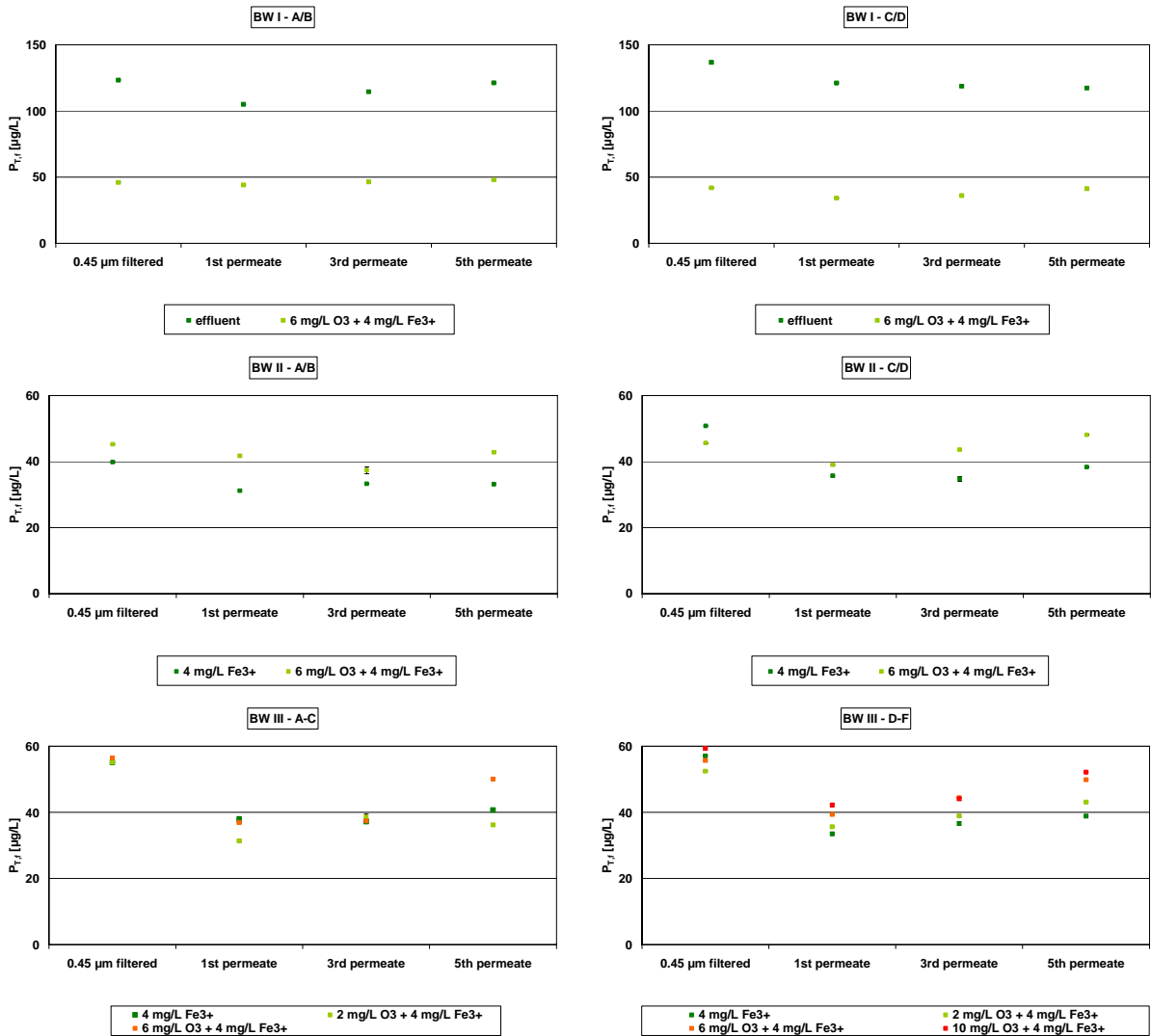
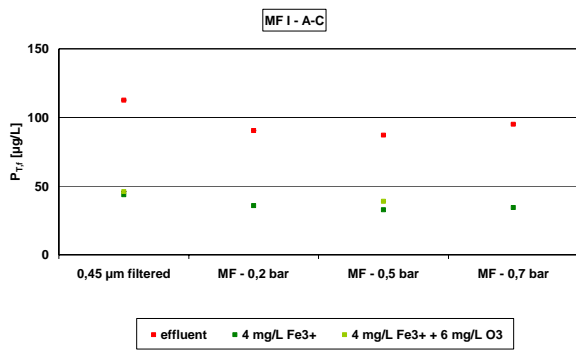
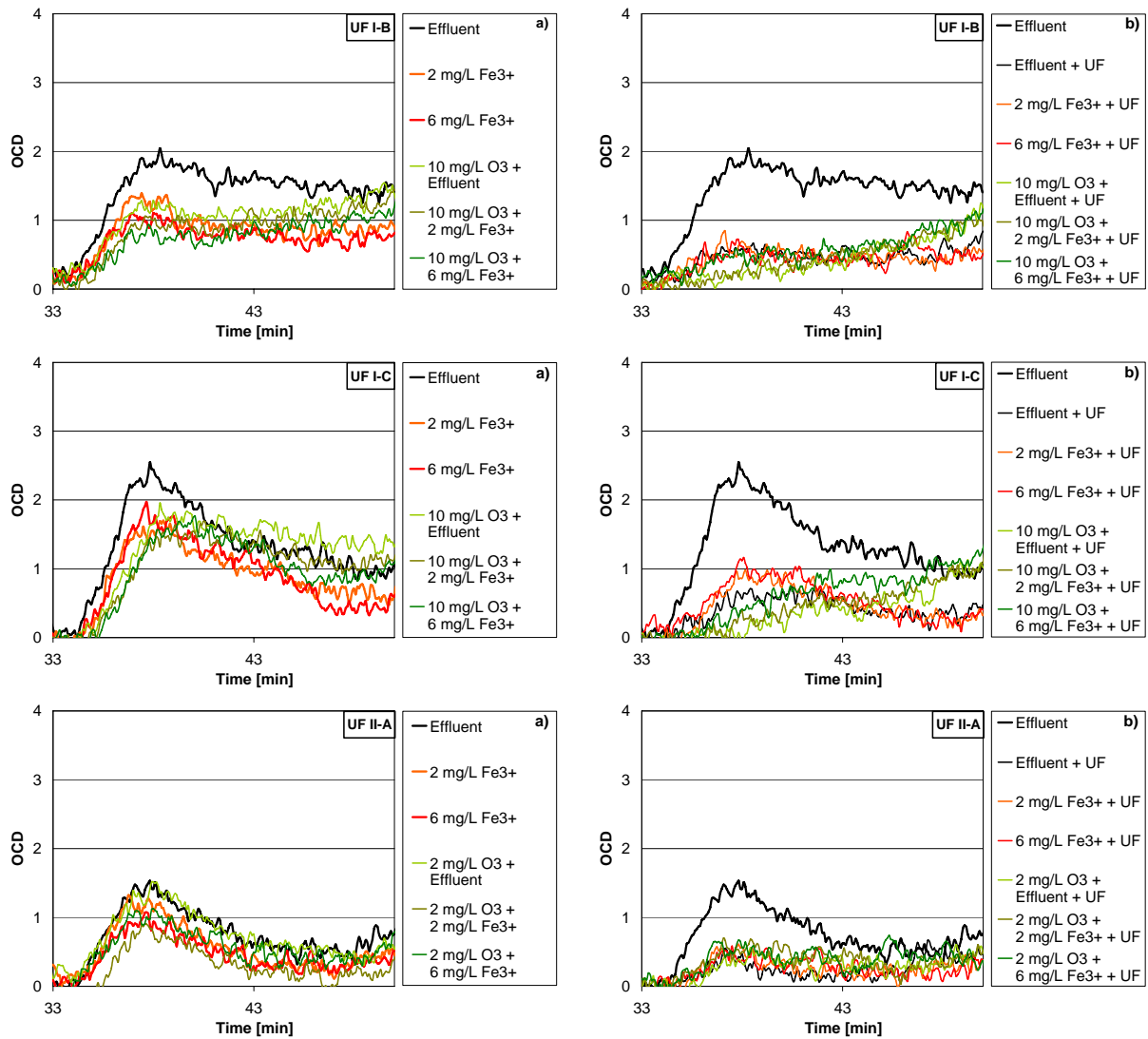

Table 11: $P_{T,f}$ results of MF trials



6.2.4 LC-OCD

Table 12: Overview of results of UF trials – BP peaks of LC-OCD diagrams of Ruhleben secondary treated effluent with different combinations of Fe^{3+} -concentrations (0 - 6 mg Fe/L) and ozone dosages (0-10 mg O_3 /L)



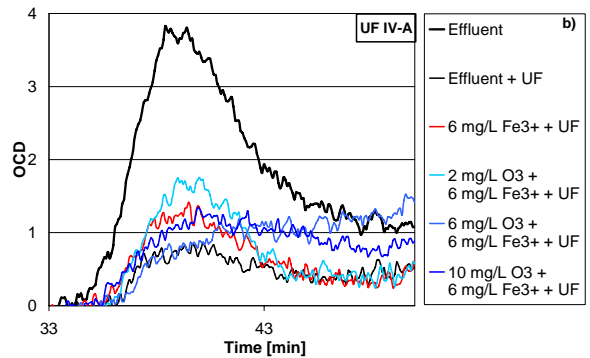
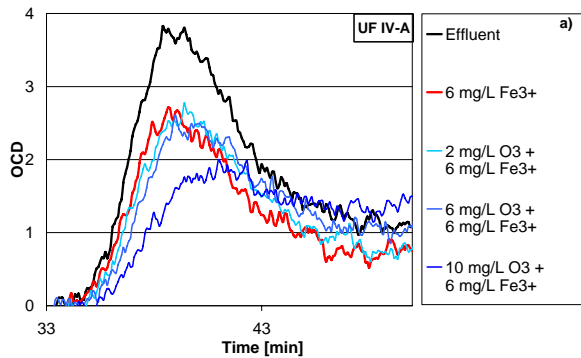
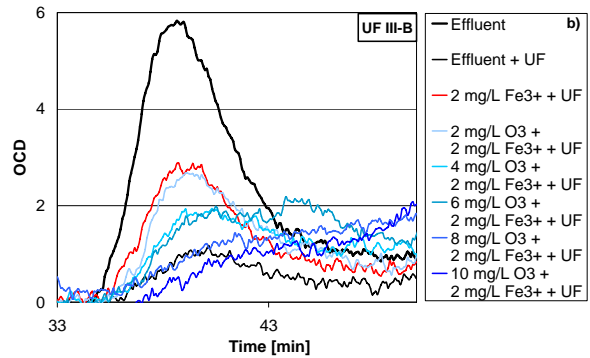
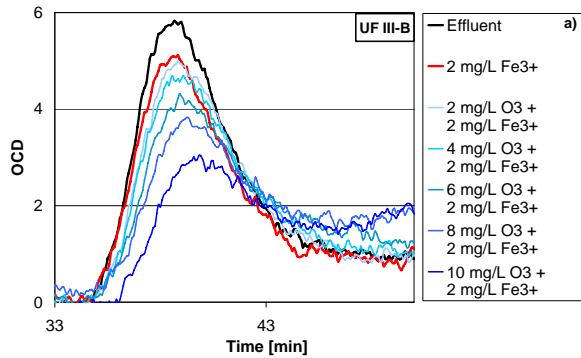
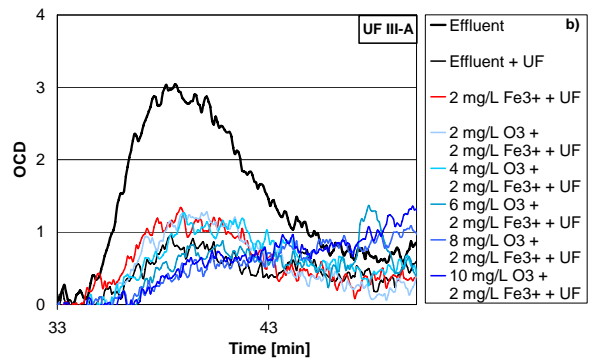
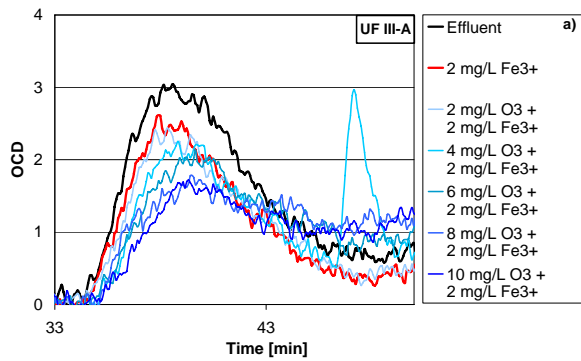
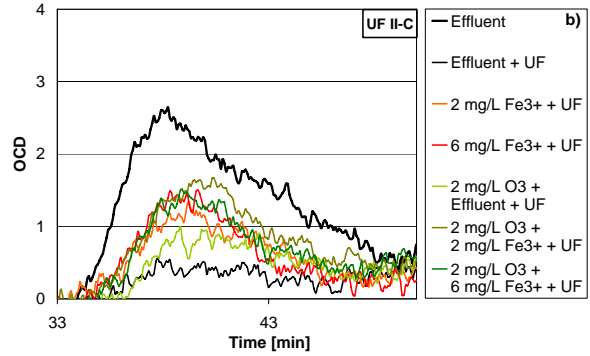
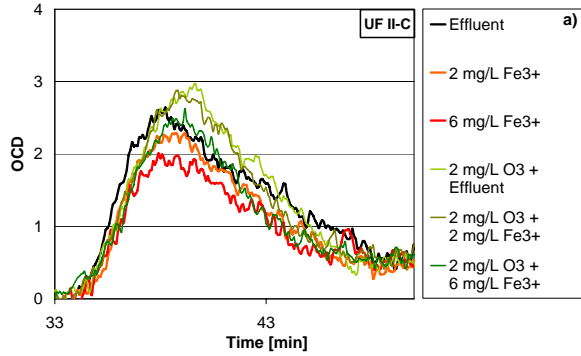
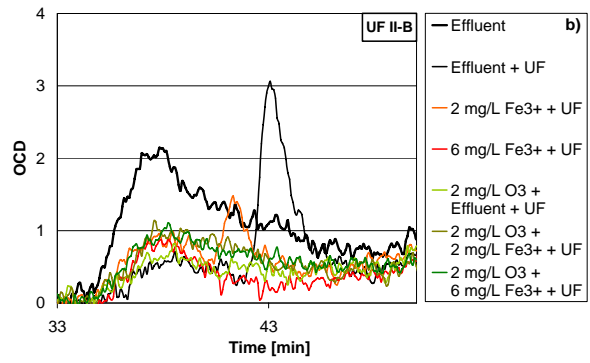
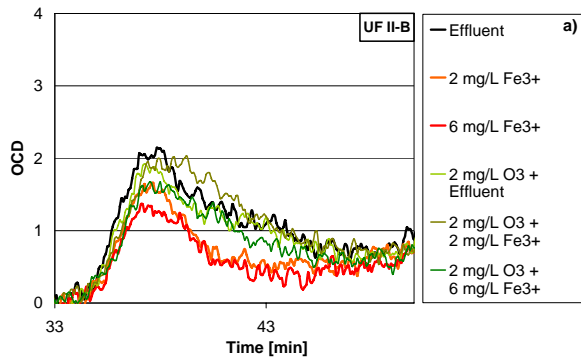

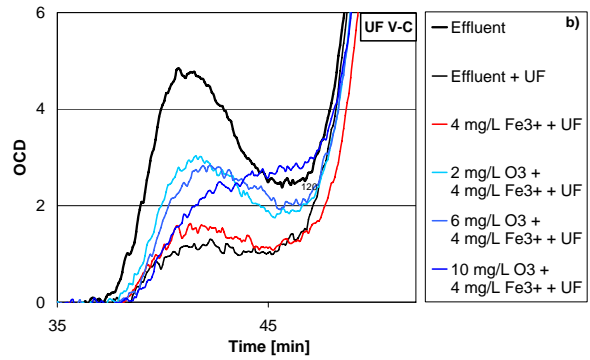
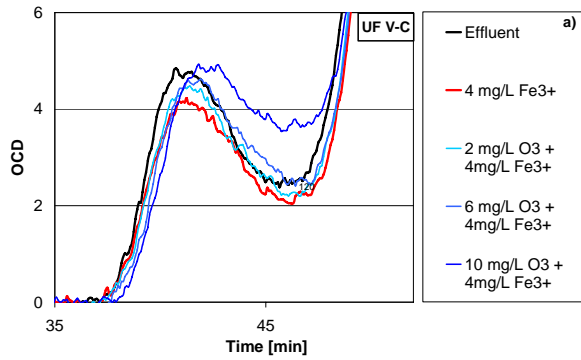
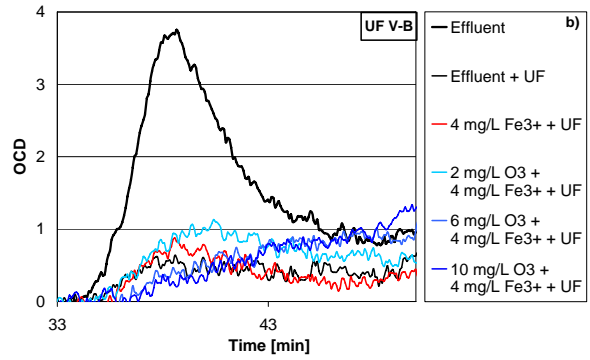
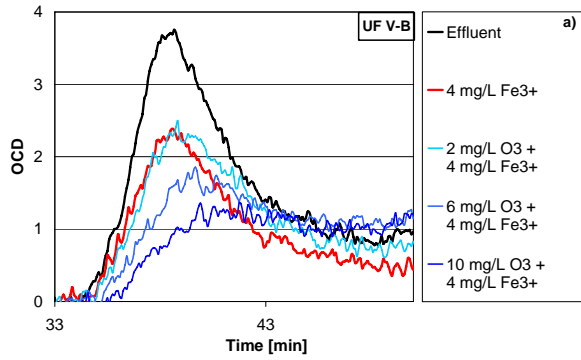
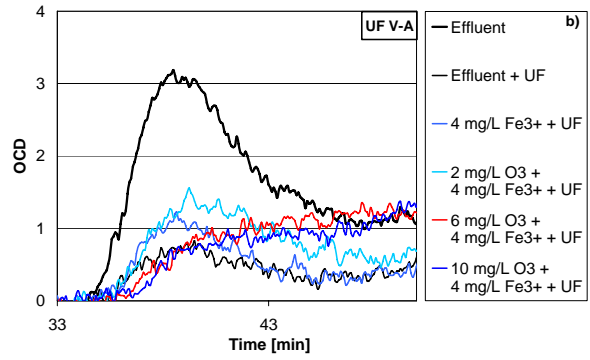
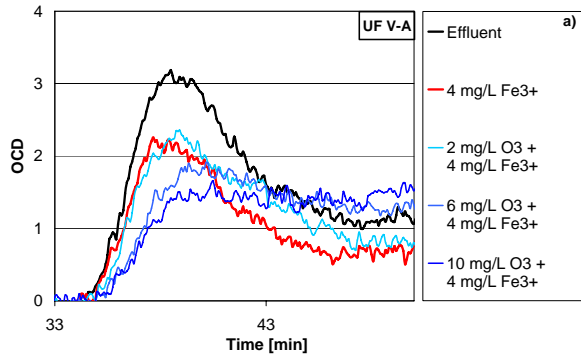
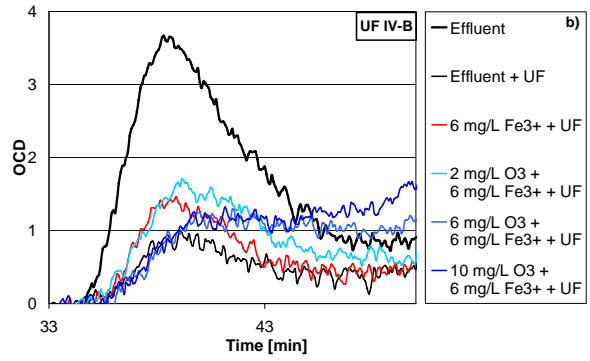
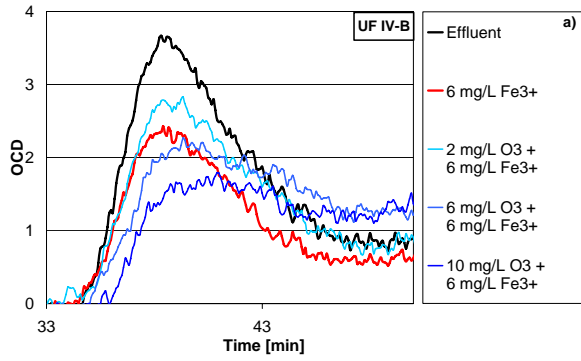
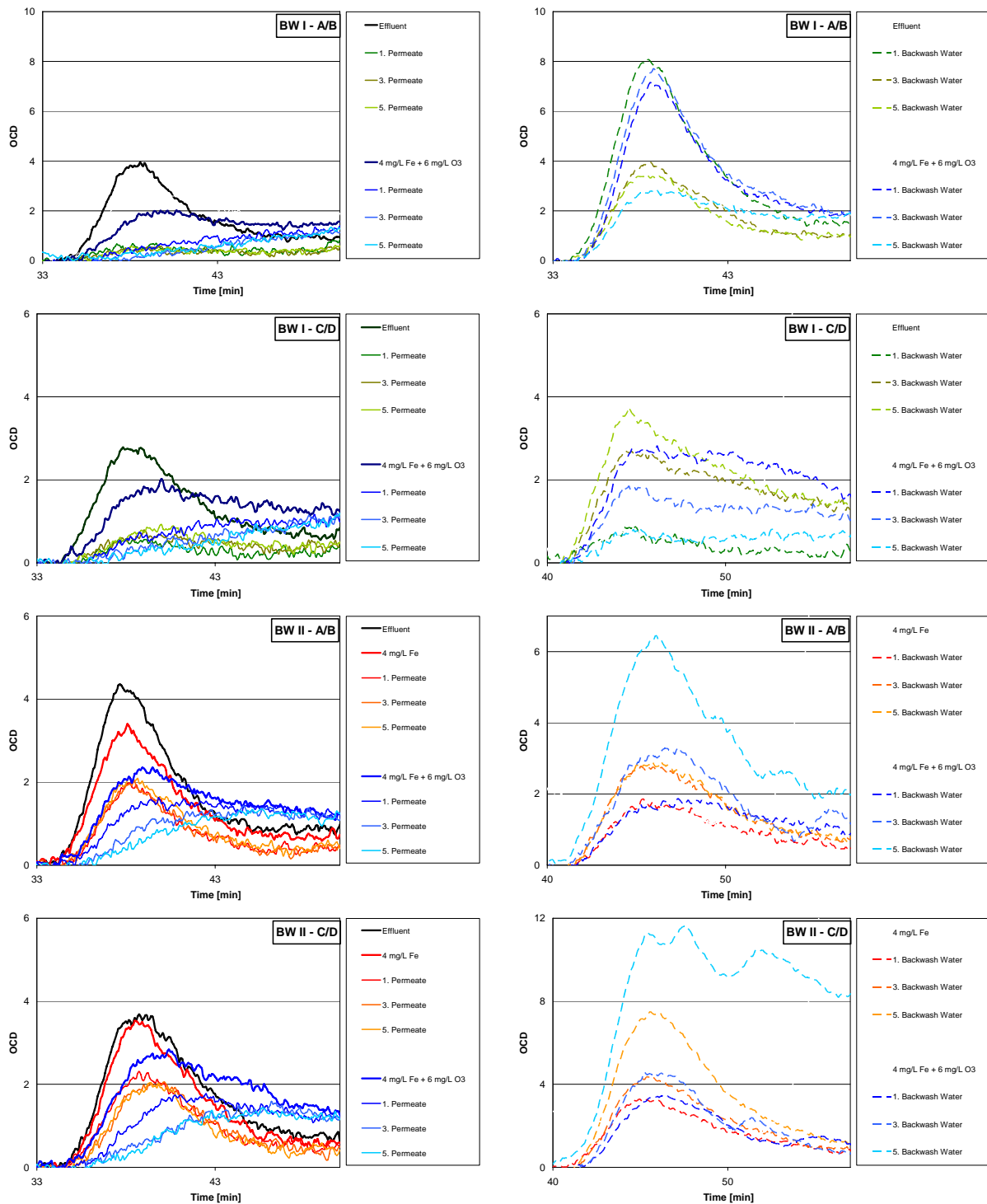

Table 13: Overview of results of BW trials – BP peaks of LC-OCD diagrams of untreated Ruhleben secondary effluent and Ruhleben secondary effluent with 4 mg Fe³⁺/L and different ozone dosages (0-10 mg O₃/L)



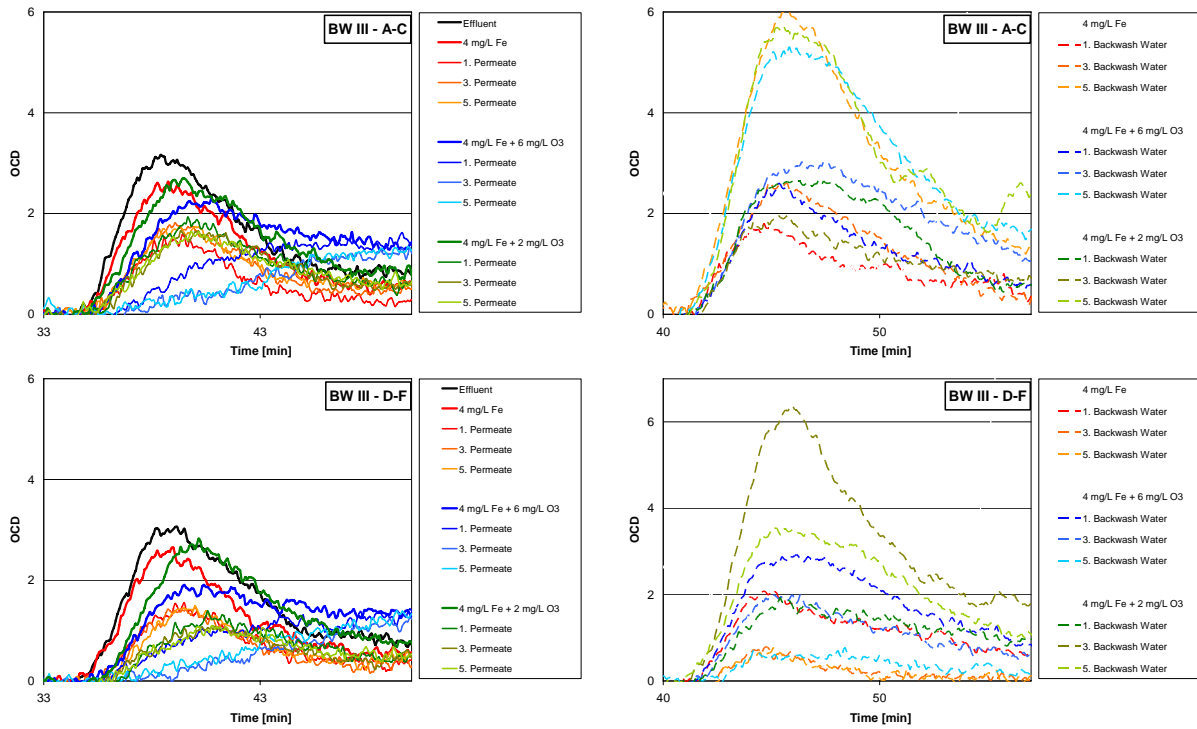
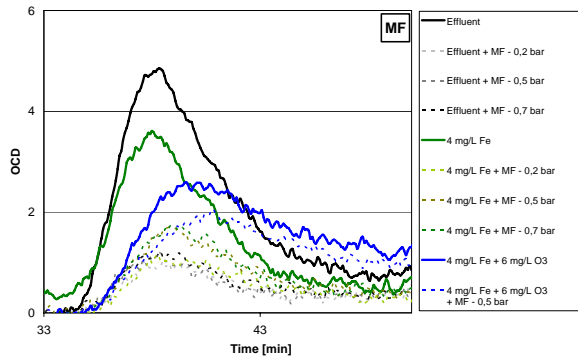
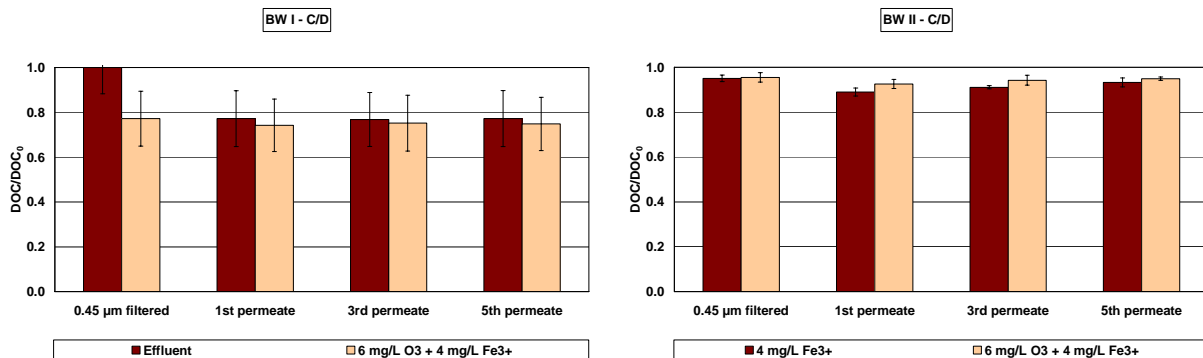

Table 14: BP peaks of LC-OCD diagrams - results of MF trials



6.2.5 DOC

Table 15: Overview of results of BW trials – DOC of untreated Ruhleben secondary effluent and Ruhleben secondary effluent with 4 mg Fe³⁺/L and different ozone dosages (0-10 mg O₃/L)



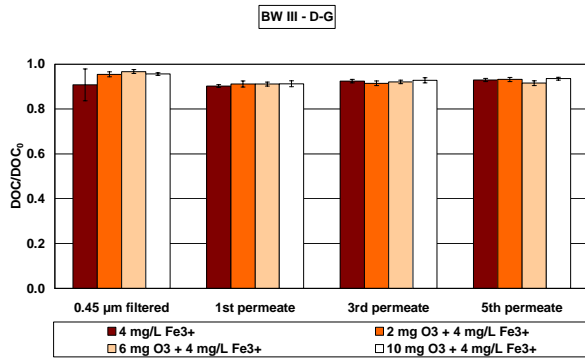

6.2.6 Residual Iron

Table 16: Overview of results of UF trials – Residual iron of Ruhleben secondary treated effluent with different combinations of Fe³⁺-concentrations (0 - 6 mg Fe/L) and ozone dosages (0-10 mg O₃/L)

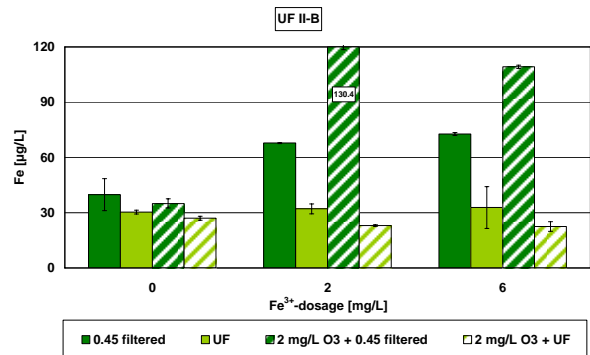
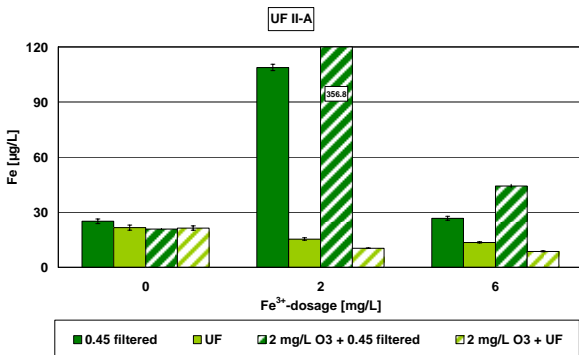
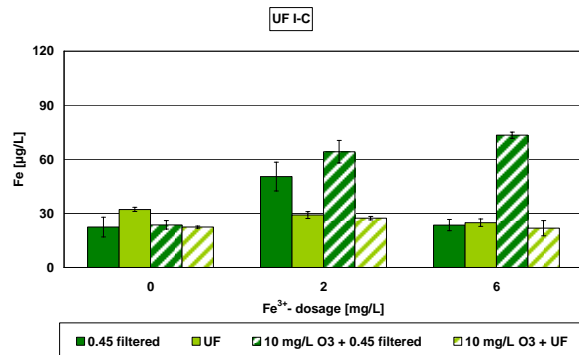
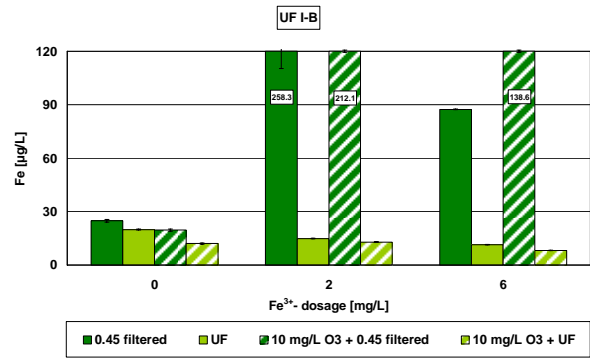
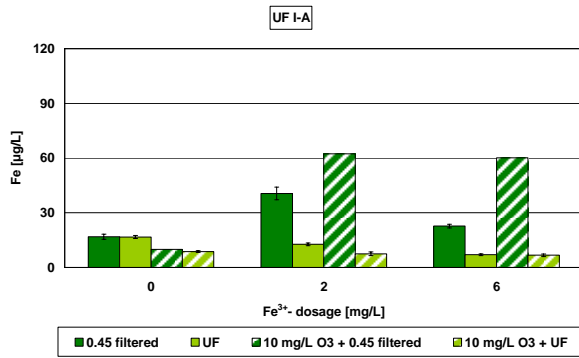

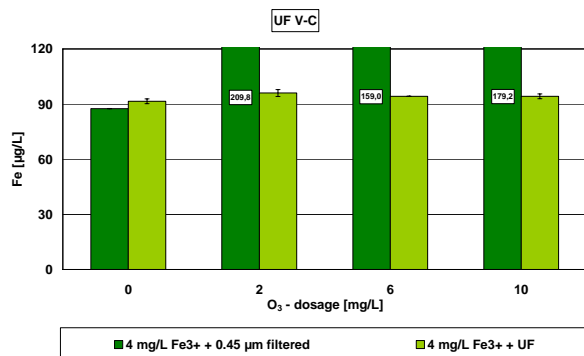
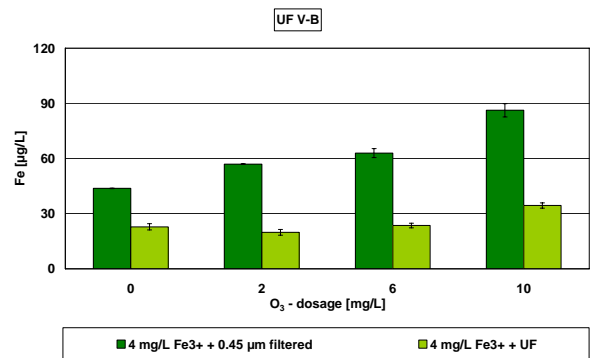
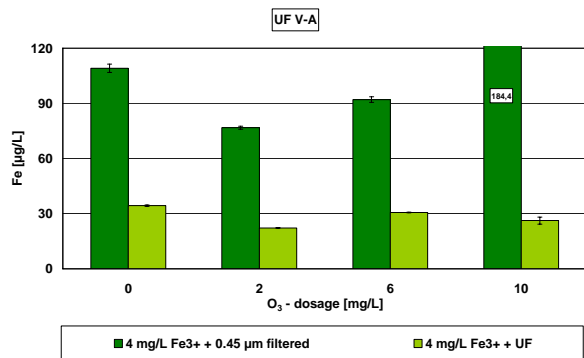
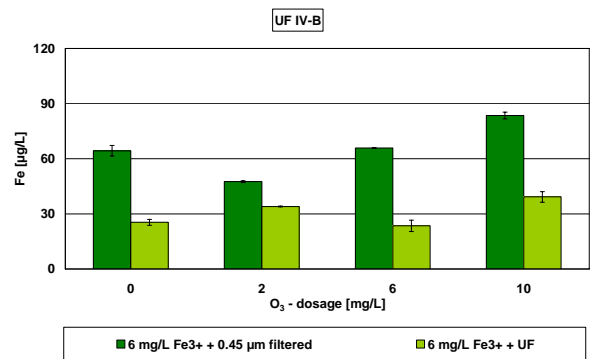
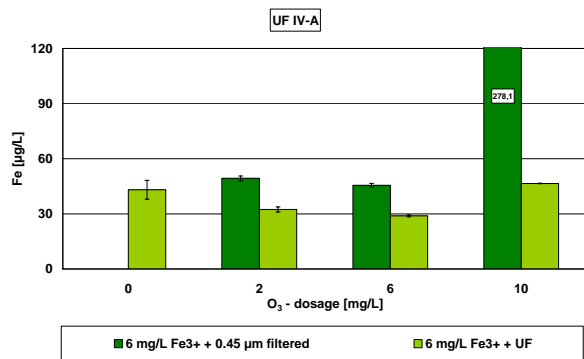
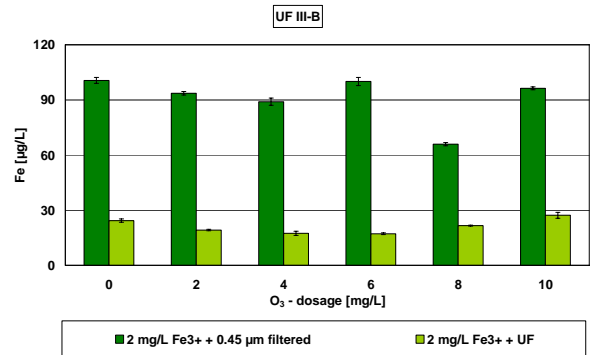
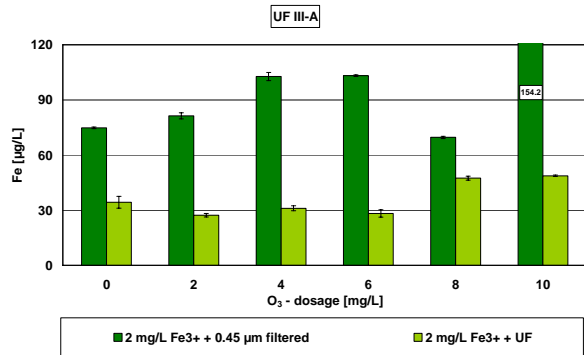
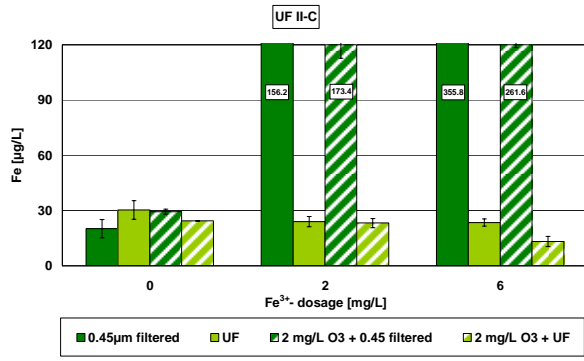
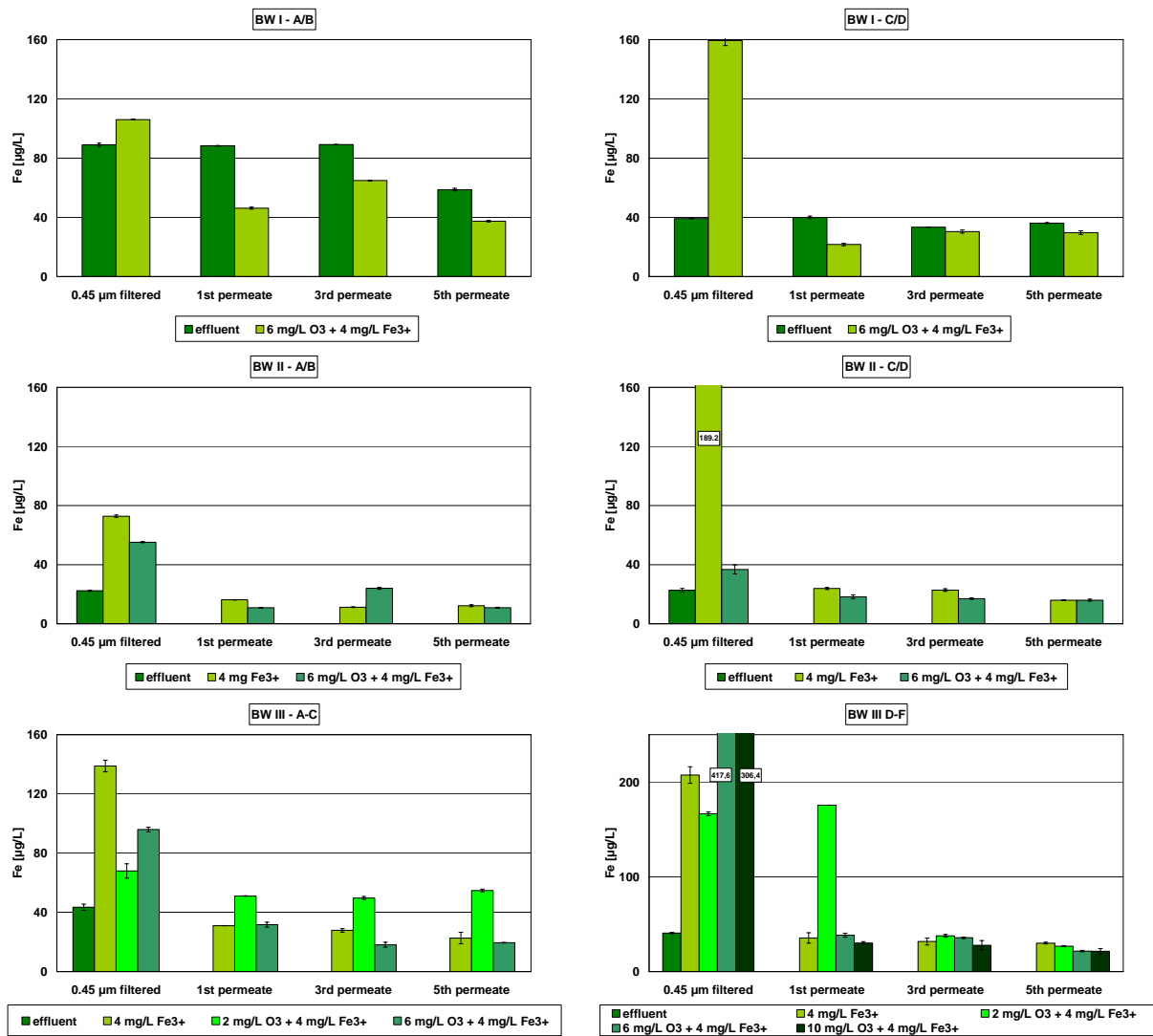
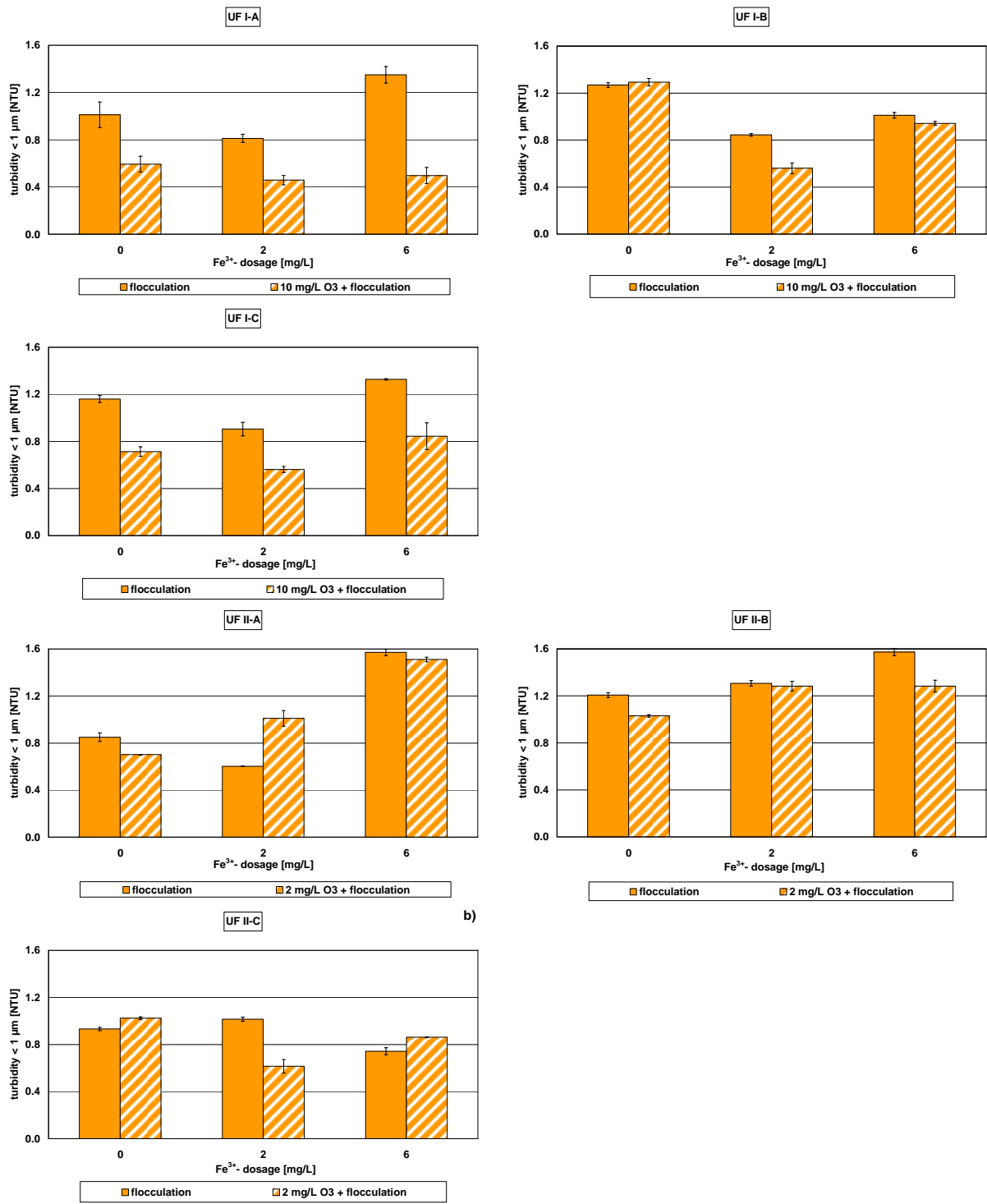

Table 17: Overview of results of BW trials – Residual iron of untreated Ruhleben secondary effluent and Ruhleben secondary effluent with 4 mg Fe³⁺/L and different ozone dosages (0-10 mg O₃/L)



6.2.7 Turbidity < 1 µm

Table 18: Overview of results of UF trials – Turbidity < 1 µm of Ruhleben secondary treated effluent with different combinations of Fe³⁺-concentrations (0 - 6 mg Fe/L) and ozone dosages (0-10 mg O₃/L)



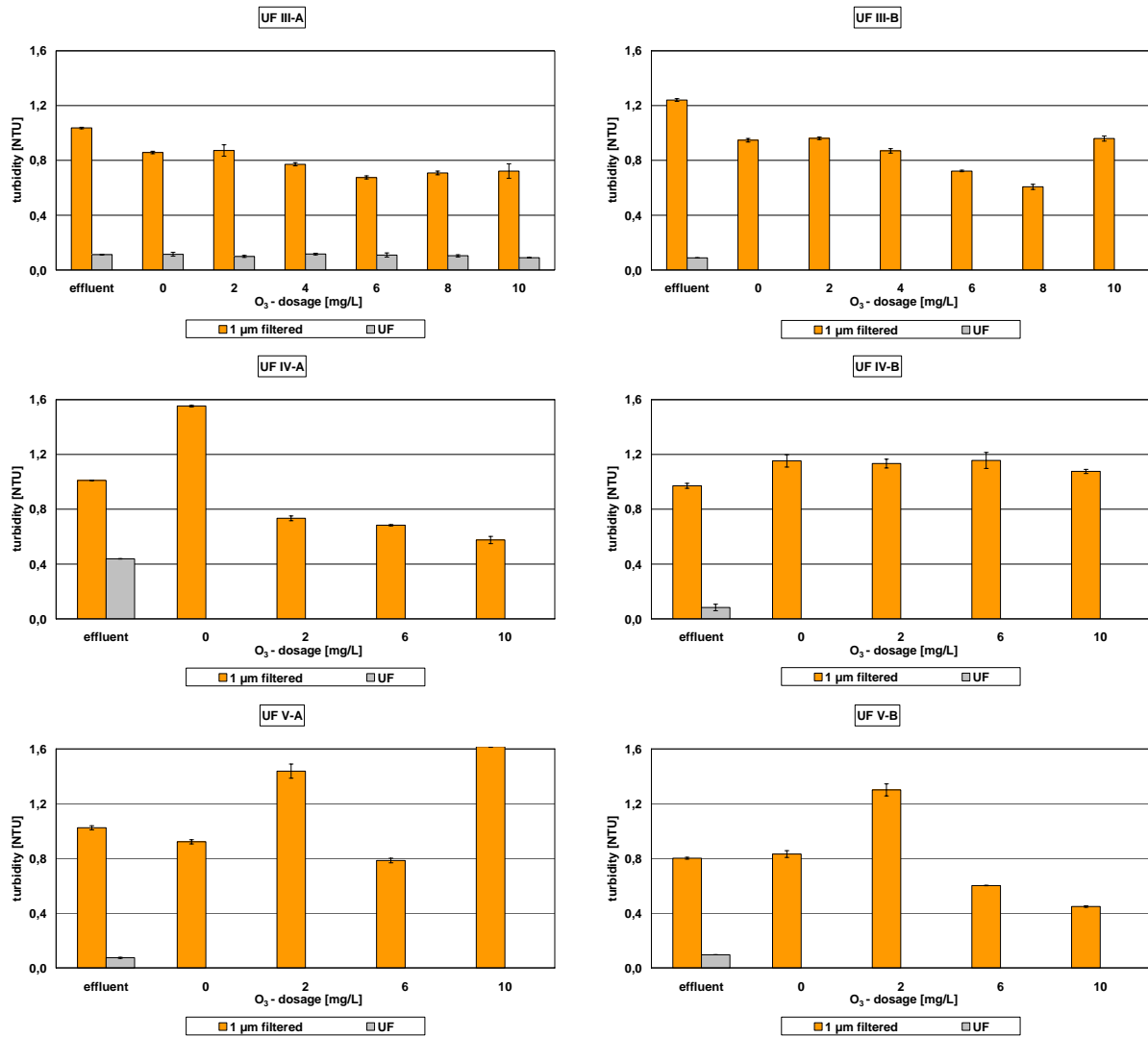

6.2.8 UVA 254

Table 19: Overview of results of BW trials – UVA 254 of untreated Ruhleben secondary effluent and Ruhleben secondary effluent with 4 mg Fe³⁺/L and different ozone dosages (0-10 mg O₃/L)

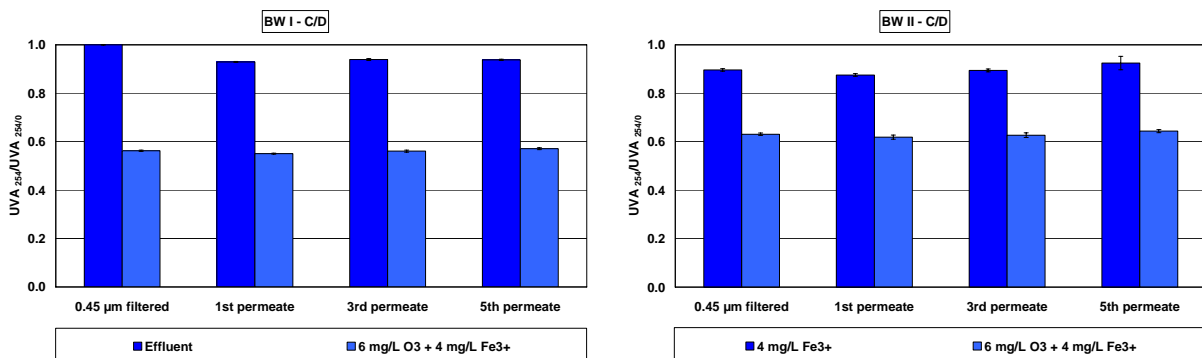

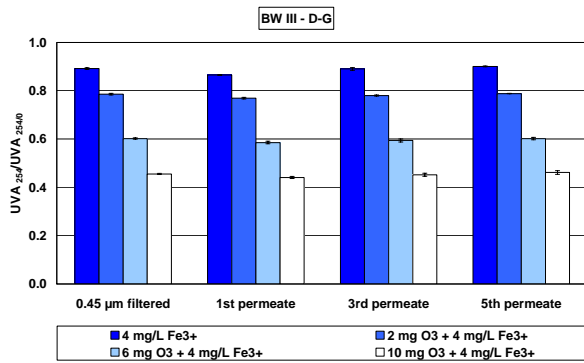

6.2.9 Colour 436

Table 20: Overview of results of BW trials – Colour 436 of untreated Ruhleben secondary effluent and Ruhleben secondary effluent with 4 mg Fe³⁺/L and different ozone dosages (0-10 mg O₃/L)

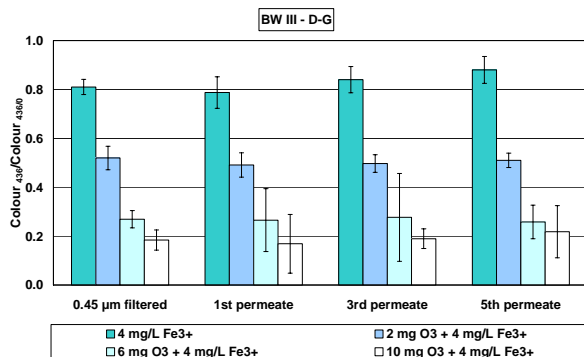
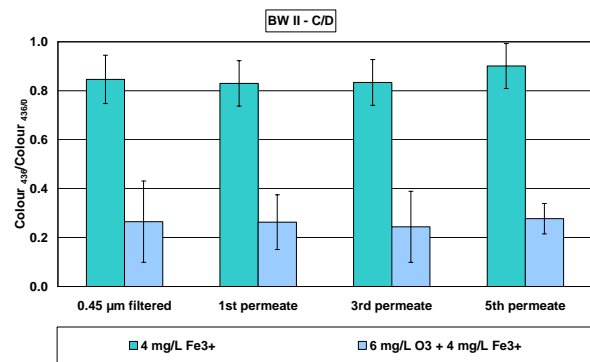
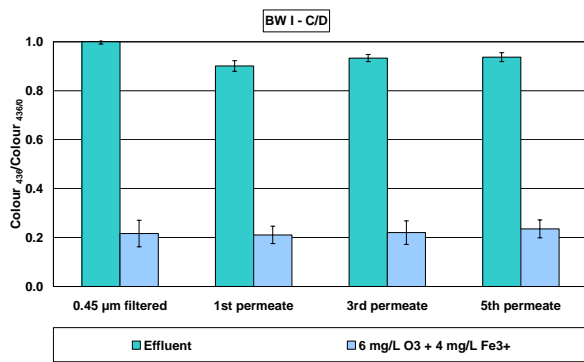

6.2.10 COD_f

Table 21: Overview of results of BW trials – COD_f of untreated Ruhleben secondary effluent and Ruhleben secondary effluent with 4 mg Fe³⁺/L and different ozone dosages (0-10 mg O₃/L)

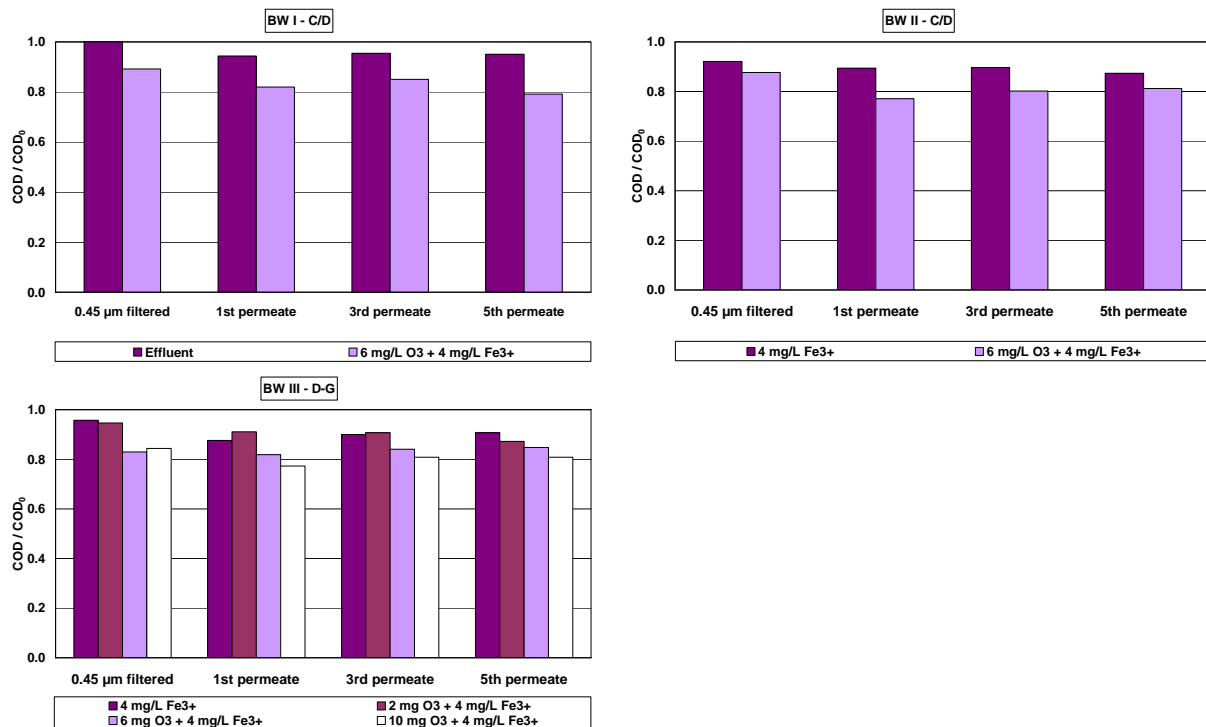

6.3 Data

6.3.1 P_{T,f}

Table 22: P_{T,f} of Ruhleben secondary treated effluent with different combinations of Fe³⁺-concentrations (0 - 6 mg Fe/L) and ozone dosages (0-10 mg O₃/L) – results of UF trials

| Name of experiment | Sample | Trial A | Trial B | Trial C |
|--------------------|---|-----------------------|-----------------------|-----------------------|
| | | Measured value [µg/L] | Measured value [µg/L] | Measured value [µg/L] |
| UF I | Effluent unfiltered | 141 | 228 ± 1.06 | 188 ± 0.31 |
| A-C | Effluent 0.45 µm filtered | 86 | 74 ± 0.46 | 104 ± 0.33 |
| | 2 mg/L Fe ³⁺ 0.45 µm filtered | 40 | 44 ± 0.20 | 46 ± 0.21 |
| | 6 mg/L Fe ³⁺ 0.45 µm filtered | 37 | 32 ± 0.11 | 30 ± 0.50 |
| | Effluent + 10 mg/L O ₃ 0.45 µm filtered | 87 | 84 ± 0.66 | 108 ± 0.33 |
| | 2 mg/L Fe ³⁺ + 10 mg/L O ₃ 0.45 µm filtered | 46 | 51 ± 0.21 | 52 ± 0.15 |
| | 6 mg/L Fe ³⁺ + 10 mg/L O ₃ 0.45 µm filtered | 38 | 37 ± 0.05 | 35 ± 0.38 |
| | Effluent + UF | 72 | 64 ± 0.43 | 87 ± 0.44 |
| | 2 mg/L Fe ³⁺ + UF | 36 | 31 ± 0.25 | 45 ± 0.77 |
| | 6 mg/L Fe ³⁺ + UF | 33 | 30 ± 0.29 | 27 ± 0.14 |

| | | | | |
|---------------|--|------------|------------|------------|
| | Effluent + 10 mg/L O ₃ + UF | 87 | 116 ± 0.69 | 130 ± 0.08 |
| | 2 mg/L Fe ³⁺ + 10 mg/L O ₃ + UF | 41 | 52 ± 0.47 | 50 ± 0.36 |
| | 6 mg/L Fe ³⁺ 10 mg/L O ₃ + UF | 34 | 35 ± 0.17 | 33 ± 0.52 |
| | Effluent unfiltered | | 400 ± 1.00 | |
| | Effluent 0.45 µm filtered | 99 ± 1.21 | 199 ± 1.55 | 105 ± 0.25 |
| | 2 mg/L Fe ³⁺ 0.45 µm filtered | 55 ± 0.14 | 67 ± 0.21 | 45 ± 0.30 |
| | 6 mg/L Fe ³⁺ 0.45 µm filtered | 42 ± 0.42 | 55 ± 0.55 | 32 ± 0.74 |
| | Effluent + 2mg/L O ₃ 0.45 µm filtered | 98 ± 0.28 | 174 ± 0.58 | 99 ± 0.11 |
| | 2 mg/L Fe ³⁺ + 2mg/L O ₃ 0.45 µm filtered | 57 ± 0.06 | 103 ± 0.30 | 49 ± 0.41 |
| UF II A-C | 6 mg/L Fe ³⁺ 2mg/L O ₃ 0.45 µm filtered | 47 ± 0.24 | 48 ± 1.09 | 149 ± 0.10 |
| | Effluent + UF | 78 ± 0.46 | 94 ± 1.25 | 75 ± 0.33 |
| | 2 mg/L Fe ³⁺ +UF | 40 ± 0.07 | 37 ± 0.54 | 30 ± 0.48 |
| | 6 mg/L Fe ³⁺ +UF | 32 ± 0.20 | 30 ± 0.45 | 22 ± 0.28 |
| | Effluent + 2mg/L O ₃ + UF | 94 ± 0.07 | 102 ± 0.09 | 96 ± 0.41 |
| | 2 mg/L Fe ³⁺ + 2mg/L O ₃ + UF | 42 ± 0.18 | 44 ± 0.32 | 40 ± 0.77 |
| | 6 mg/L Fe ³⁺ 2mg/L O ₃ + UF | 32 ± 0.16 | 42 ± 0.36 | 52 ± 0.83 |
| | Effluent unfiltered | | 356 ± 0.24 | |
| | Effluent 0.45 µm filtered | 137 ± 0.17 | 153 ± 0.30 | |
| | 2 mg/L Fe ³⁺ 0.45 µm filtered | 54 ± 0.61 | 67 ± 0.15 | |
| | 2 mg/L Fe ³⁺ + 2mg/L O ₃ 0.45 µm filtered | 58 ± 0.27 | 65 ± 0.04 | |
| | 2 mg/L Fe ³⁺ + 4 mg/L O ₃ 0.45 µm filtered | 61 ± 0.24 | 69 ± 0.21 | |
| | 2 mg/L Fe ³⁺ + 6 mg/L O ₃ 0.45 µm filtered | 57 ± 0.40 | 70 ± 0.30 | |
| | 2 mg/L Fe ³⁺ + 8 mg/L O ₃ 0.45 µm filtered | 65 ± 0.46 | 71 ± 0.32 | |
| UF III A-B | 2 mg/L Fe ³⁺ + 10 mg/L O ₃ 0.45 µm filtered | 69 ± 0.23 | 85 ± 0.20 | |
| | Effluent + UF | 127 ± 0.15 | 157 ± 0.53 | |
| | 2 mg/L Fe ³⁺ +UF | 49 ± 0.43 | 52 ± 0.14 | |
| | 2 mg/L Fe ³⁺ + 2 mg/L O ₃ + UF | 50 ± 0.27 | 58 ± 0.13 | |
| | 2 mg/L Fe ³⁺ + 4 mg/L O ₃ + UF | 47 ± 0.23 | 63 ± 0.36 | |
| | 2 mg/L Fe ³⁺ + 6 mg/L O ₃ + UF | 52 ± 0.50 | 71 ± 0.19 | |
| | 2 mg/L Fe ³⁺ + 8 mg/L O ₃ + UF | 56 ± 0.17 | 72 ± 0.40 | |
| | 2 mg/L Fe ³⁺ + 10 mg/L O ₃ + UF | 57 ± 0.30 | 78 ± 0.24 | |
| UF IV A-B | Effluent unfiltered | 763 | 246 ± 0.84 | |
| | Effluent 0.45 µm filtered | 252 ± 0.95 | 101 ± 0.38 | |

| | | | | |
|-------------|--|------------|------------|------------|
| | 6 mg/L Fe ³⁺ 0.45 µm filtered | 51 ± 0.33 | 32 ± 0.67 | |
| | 6 mg/L Fe ³⁺ + 2 mg/L O ₃ 0.45 µm filtered | 43 ± 0.25 | 36 ± 0.16 | |
| | 6 mg/L Fe ³⁺ + 6 mg/L O ₃ 0.45 µm filtered | 44 ± 0.06 | 37 ± 0.45 | |
| | 6 mg/L Fe ³⁺ + 10 mg/L O ₃ 0.45 µm filtered | 50 ± 0.19 | 42 ± 0.38 | |
| | Effluent + UF | 219 ± 0.78 | 83 ± 0.63 | |
| | 6 mg/L Fe ³⁺ + UF | 34 ± 0.37 | 111 ± 0.33 | |
| | 6 mg/L Fe ³⁺ + 2 mg/L O ₃ + UF | 38 ± 0.15 | 35 ± 0.70 | |
| | 6 mg/L Fe ³⁺ + 6 mg/L O ₃ + UF | 43 | 32 ± 0.39 | |
| | 6 mg/L Fe ³⁺ + 10 mg/L O ₃ + UF | 47 | 35 ± 0.16 | |
| | Effluent unfiltered | 314 ± 0.73 | 207 ± 0.53 | 337 ± 0.27 |
| | Effluent 0.45 µm filtered | 90 ± 0.39 | 112 ± 0.35 | 123 ± 0.41 |
| | 4 mg/L Fe ³⁺ 0.45 µm filtered | 35 ± 0.71 | 35 ± 0.39 | 43 ± 0.09 |
| | 4 mg/L Fe ³⁺ + 2 mg/L O ₃ 0.45 µm filtered | 34 ± 0.37 | 36 ± 0.26 | 48 ± 0.20 |
| | 4 mg/L Fe ³⁺ + 6 mg/L O ₃ 0.45 µm filtered | 42 ± 0.87 | 38 ± 0.70 | 41 ± 0.22 |
| UF V A-C | 4 mg/L Fe ³⁺ + 10 mg/L O ₃ 0.45 µm filtered | 39 ± 0.73 | 46 ± 0.30 | 47 ± 0.20 |
| | Effluent + UF | 72 ± 0.42 | 85 ± 0.61 | 86 ± 0.23 |
| | 4 mg/L Fe ³⁺ 1 µm filtered | 28 ± 0.63 | 29 ± 0.34 | 28 ± 0.45 |
| | 4 mg/L Fe ³⁺ + 2 mg/L O ₃ + UF | 30 ± 0.54 | 29 ± 0.19 | 30 ± 0.25 |
| | 4 mg/L Fe ³⁺ + 6 mg/L O ₃ + UF | 30 ± 0.51 | 34 ± 0.28 | 31 ± 0.17 |
| | 4 mg/L Fe ³⁺ + 10 mg/L O ₃ + UF | 32 ± 0.15 | 46 ± 0.20 | 38 ± 0.16 |

Table 23: P_{T,f} of untreated Ruhleben secondary effluent and Ruhleben secondary effluent with 4 mg Fe³⁺/L and different ozone dosages (0-10 mg O₃/L) – results of BW trials

| Name of experiment | Sample | Trial 1 | Trial 2 | Trial 3 |
|--------------------|--|-----------------------|-----------------------|-----------------------|
| | | Measured value [µg/L] | Measured value [µg/L] | Measured value [µg/L] |
| BW I | Effluent unfiltered | 290 ± 0.79 | | |
| | Effluent 0.45 µm filtered | 123 ± 0.45 | 137 ± 0.84 | |
| | Effluent + UF 1 st permeate | 105 ± 0.17 | 121 ± 0.40 | |
| BW I A/C | Effluent + UF 3 rd permeate | 115 ± 0.23 | 119 ± 0.08 | |
| | Effluent + UF 5 th permeate | 121 ± 0.25 | 117 ± 0.64 | |

| | | | | |
|---------------|---|------------|------------|------------|
| | 4 mg/L Fe ³⁺ + 6 mg/L O ₃ | 46 ± 0.57 | 42 ± 0.16 | |
| BW I B/D | 4 mg/L Fe ³⁺ + 6 mg/L O ₃ + UF 1 st permeate | 44 ± 0.57 | 34 ± 0.25 | |
| | 4 mg/L Fe ³⁺ + 6 mg/L O ₃ + UF 3 rd permeate | 46 ± 0.09 | 36 ± 0.13 | |
| | 4 mg/L Fe ³⁺ + 6 mg/L O ₃ + UF 5 th permeate | 48 ± 0.38 | 41 ± 0.35 | |
| | Effluent unfiltered | | 419 ± 0.47 | 383 ± 0.95 |
| BW II | Effluent 0.45 µm filtered | | 96 ± 0.18 | 113 ± 0.27 |
| BW II A/C | 4 mg/L Fe ³⁺ | | 40 ± 0.30 | 51 ± 0.10 |
| | 4 mg/L Fe ³⁺ + UF 1 st permeate | | 31 ± 0.26 | 36 ± 0.25 |
| | 4 mg/L Fe ³⁺ + UF 3 rd permeate | | 33 ± 0.17 | 35 ± 0.73 |
| | 4 mg/L Fe ³⁺ + UF 5 th permeate | | 33 ± 0.26 | 38 ± 0.19 |
| BW II B/D | 4 mg/L Fe ³⁺ + 6 mg/L O ₃ | | 45 ± 0.10 | 46 ± 0.12 |
| | 4 mg/L Fe ³⁺ + 6 mg/L O ₃ + UF 1 st permeate | | 42 ± 0.36 | 39 ± 0.16 |
| | 4 mg/L Fe ³⁺ + 6 mg/L O ₃ + UF 3 rd permeate | | 37 ± 1.02 | 44 ± 0.15 |
| | 4 mg/L Fe ³⁺ + 6 mg/L O ₃ + UF 5 th permeate | | 43 ± 0.27 | 48 ± 0.08 |
| | Effluent unfiltered | 334 ± 0.43 | 420 ± 0.87 | |
| BW III | Effluent 0.45 µm filtered | 130 ± 0.53 | 164 ± 0.34 | |
| BW III A/D | 4 mg/L Fe ³⁺ | 55 ± 0.14 | 57 ± 0.19 | |
| | 4 mg/L Fe ³⁺ + UF 1 st permeate | 38 ± 0.81 | 33 ± 0.39 | |
| | 4 mg/L Fe ³⁺ + UF 3 rd permeate | 37 ± 0.49 | 37 ± 0.52 | |
| | 4 mg/L Fe ³⁺ + UF 5 th permeate | 41 ± 0.26 | 39 ± 0.31 | |
| BW III B/E | 4 mg/L Fe ³⁺ + 2 mg/L O ₃ | 55 ± 0.18 | 52 ± 0.14 | |
| | 4 mg/L Fe ³⁺ + 2 mg/L O ₃ + UF 1 st permeate | 31 ± 0.29 | 36 ± 0.19 | |

| | | | |
|---------------|--|-----------|-----------|
| | 4 mg/L Fe ³⁺ + 2 mg/L O ₃ + UF 3 rd permeate | 39 ± 0.87 | 39 ± 0.29 |
| | 4 mg/L Fe ³⁺ + 2 mg/L O ₃ + UF 5 th permeate | 36 ± 0.27 | 43 ± 0.24 |
| | 4 mg/L Fe ³⁺ + 6 mg/L O ₃ | 56 ± 0.15 | 56 ± 0.28 |
| BW III C/F | 4 mg/L Fe ³⁺ + 6 mg/L O ₃ + UF 1 st permeate | 37 ± 0.24 | 39 ± 0.20 |
| | 4 mg/L Fe ³⁺ + 6 mg/L O ₃ + UF 3 rd permeate | 37 ± 0.65 | 44 ± 0.22 |
| | 4 mg/L Fe ³⁺ + 6 mg/L O ₃ + UF 5 th permeate | 50 ± 0.41 | 50 ± 0.10 |
| | 4 mg/L Fe ³⁺ + 10 mg/L O ₃ | | 59 ± 0.32 |
| | 4 mg/L Fe ³⁺ + 10 mg/L O ₃ + UF 1 st permeate | | 42 ± 0.45 |
| BW III G | 4 mg/L Fe ³⁺ + 10 mg/L O ₃ + UF 3 rd permeate | | 44 ± 0.39 |
| | 4 mg/L Fe ³⁺ + 10 mg/L O ₃ + UF 5 th permeate | | 52 ± 0.21 |

Table 24: P_{T,f} results of MF trials

| Name of experiment | Sample | Measured value [µg/L] |
|--------------------|---|-----------------------|
| | Effluent 0.45 µm filtered | 113 ± 0.17 |
| | Effluent + MF 0.2 bar | 90 ± 0.21 |
| | Effluent + MF 0.5 bar | 87 ± 0.18 |
| | Effluent + MF 0.7 bar | 95 ± 0.60 |
| MF I A-C | 4 mg/L Fe ³⁺ 0.45 µm filtered | 44 ± 0.07 |
| | 4 mg/L Fe ³⁺ +UF 0.2 bar | 36 ± 0.02 |
| | 4 mg/L Fe ³⁺ +UF 0.5 bar | 33 ± 0.09 |
| | 4 mg/L Fe ³⁺ +UF 0.7 bar | 34 ± 0.08 |
| | 4 mg/L Fe ³⁺ + 6 mg/L O ₃ 0.45 µm filtered | 46 ± 0.08 |
| | 4 mg/L Fe ³⁺ + 6 mg/L O ₃ 0.5 bar | 39 ± 0.06 |

6.3.2 PO₄-P

Table 25: PO₄-P of Ruhleben secondary treated effluent with different combinations of Fe³⁺-concentrations (0 - 6 mg Fe/L) and ozone dosages (0-10 mg O₃/L) – results of UF trials

| | Trial A | Trial B | Trial C |
|--|---------|---------|---------|
|--|---------|---------|---------|

| Name of experiment | Sample | Measured value [$\mu\text{g/L}$] | Measured value [$\mu\text{g/L}$] | Measured value [$\mu\text{g/L}$] | |
|---|---|--|---------------------------------------|---------------------------------------|---------------|
| UF I A-C | Effluent 0.45 μm filtered | 46 \pm 0.72 | 34 \pm 0.30 | 57 \pm 0.32 | |
| | 2 mg/L Fe^{3+} 0.45 μm filtered | 11 \pm 0.25 | 13 \pm 0.19 | 17 \pm 0.36 | |
| | 6 mg/L Fe^{3+} 0.45 μm filtered | 7 \pm 0.20 | 8 \pm 0.20 | 13 \pm 0.43 | |
| | Effluent + 10 mg/L O_3 0.45 μm filtered | 45 \pm 0.93 | 39 \pm 0.22 | 69 \pm 1.03 | |
| | 2 mg/L Fe^{3+} + 10 mg/L O_3 0.45 μm filtered | 15 \pm 0.96 | 15 \pm 0.22 | 26 \pm 0.18 | |
| | 6 mg/L Fe^{3+} 10 mg/L O_3 0.45 μm filtered | 8 \pm 0.51 | 10 \pm 0.20 | 15 \pm 0.51 | |
| | Effluent + UF | 39 \pm 0.37 | 30 \pm 0.28 | 51 \pm 0.35 | |
| | 2 mg/L Fe^{3+} +UF | 7 \pm 0.23 | 8 \pm 0.13 | 11 \pm 0.21 | |
| | 6 mg/L Fe^{3+} +UF | 6 \pm 0.40 | 7 \pm 0.13 | 10 \pm 0.32 | |
| | Effluent + 10 mg/L O_3 + UF | 49 \pm 0.43 | 47 \pm 0.63 | 73 \pm 0.32 | |
| | 2 mg/L Fe^{3+} + 10 mg/L O_3 + UF | 11 \pm 0.35 | 17 \pm 0.16 | 20 \pm 0.12 | |
| | 6 mg/L Fe^{3+} 10 mg/L O_3 + UF | 8 \pm 0.39 | 9 \pm 0.39 | 11 \pm 0.22 | |
| | UF II A-C | Effluent 0.45 μm filtered | 53 \pm 0.28 | 73 \pm 0.21 | 55 \pm 1.16 |
| | | 2 mg/L Fe^{3+} 0.45 μm filtered | 14 \pm 0.07 | 23 \pm 0.15 | 21 \pm 0.48 |
| 6 mg/L Fe^{3+} 0.45 μm filtered | | 11 \pm 0.79 | 75 \pm 0.45 | 17 \pm 0.26 | |
| Effluent + 2mg/L O_3 0.45 μm filtered | | 59 \pm 0.75 | 79 \pm 0.24 | 63 \pm 0.36 | |
| 2 mg/L Fe^{3+} + 2mg/L O_3 0.45 μm filtered | | 18 \pm 0.40 | 26 \pm 0.15 | 25 \pm 0.23 | |
| 6 mg/L Fe^{3+} 2mg/L O_3 0.45 μm filtered | | 11 \pm 0.16 | 17 \pm 0.49 | 18 \pm 0.75 | |
| Effluent + UF | | 48 \pm 1.35 | 77 \pm 0.71 | 57 \pm 1.16 | |
| 2 mg/L Fe^{3+} +UF | | 9 \pm 0.67 | 21 \pm 0.15 | 15 \pm 0.29 | |
| 6 mg/L Fe^{3+} +UF | | 10 \pm 0.57 | 22 \pm 0.96 | 13 \pm 0.18 | |
| Effluent + 2mg/L O_3 + UF | | 54 \pm 0.44 | 82 \pm 0.88 | 67 \pm 1.09 | |
| 2 mg/L Fe^{3+} + 2mg/L O_3 + UF | | 10 \pm 0.20 | 56 \pm 0.70 | 20 \pm 0.65 | |
| 6 mg/L Fe^{3+} 2mg/L O_3 + UF | | 10 \pm 0.15 | 33 \pm 0.72 | 14 \pm 1.10 | |
| UF III A-B | | Effluent 0.45 μm filtered | 82 \pm 0.85 | 107 \pm 1.06 | |
| | | 2 mg/L Fe^{3+} 0.45 μm filtered | 21 \pm 1.10 | 24 \pm 0.25 | |
| | 2 mg/L Fe^{3+} + 2mg/L O_3 0.45 μm filtered | 24 \pm 1.02 | 23 \pm 0.61 | | |
| | 2 mg/L Fe^{3+} + 4 mg/L O_3 0.45 μm filtered | 30 \pm 1.04 | 31 \pm 0.63 | | |
| | 2 mg/L Fe^{3+} + 6 mg/L O_3 0.45 μm filtered | 28 \pm 1.13 | 36 \pm 0.67 | | |
| | 2 mg/L Fe^{3+} + 8 mg/L O_3 0.45 μm filtered | 32 \pm 1.20 | 37 \pm 0.36 | | |
| | 2 mg/L Fe^{3+} + 10 mg/L O_3 0.45 μm filtered | 31 \pm 1.08 | 46 \pm 0.54 | | |
| | Effluent + UF | 79 \pm 1.03 | 105 \pm 1.01 | | |

| | | | | | |
|--|--|---|-----------|-----------|-----------|
| | 2 mg/L Fe ³⁺ +UF | 17 ± 0.40 | 19 ± 0.43 | | |
| | 2 mg/L Fe ³⁺ + 2 mg/L O ₃ + UF | 18 ± 0.41 | 23 ± 0.64 | | |
| | 2 mg/L Fe ³⁺ + 4 mg/L O ₃ + UF | 19 ± 0.32 | 31 ± 0.06 | | |
| | 2 mg/L Fe ³⁺ + 6 mg/L O ₃ + UF | 22 ± 0.27 | 34 ± 0.79 | | |
| | 2 mg/L Fe ³⁺ + 8 mg/L O ₃ + UF | 24 ± 0.28 | 36 ± 0.08 | | |
| | 2 mg/L Fe ³⁺ + 10 mg/L O ₃ + UF | 25 ± 0.38 | 40 ± 0.13 | | |
| UF IV A-B | Effluent 0.45 µm filtered | 199 ± 0.53 | 78 ± 1.14 | | |
| | 6 mg/L Fe ³⁺ 0.45 µm filtered | 13 ± 0.19 | 17 ± 0.39 | | |
| | 6 mg/L Fe ³⁺ + 2 mg/L O ₃ 0.45 µm filtered | 15 ± 0.09 | 18 ± 0.29 | | |
| | 6 mg/L Fe ³⁺ + 6 mg/L O ₃ 0.45 µm filtered | 17 ± 0.23 | 18 ± 0.40 | | |
| | 6 mg/L Fe ³⁺ + 10 mg/L O ₃ 0.45 µm filtered | 18 ± 0.18 | 17 ± 0.38 | | |
| | Effluent + UF | 187 ± 0.52 | 69 ± 0.79 | | |
| | 6 mg/L Fe ³⁺ + UF | 12 ± 0.59 | 13 ± 0.25 | | |
| | 6 mg/L Fe ³⁺ + 2 mg/L O ₃ + UF | 12 ± 0.05 | 14 ± 0.46 | | |
| | 6 mg/L Fe ³⁺ + 6 mg/L O ₃ + UF | 13 ± 0.25 | 14 ± 0.63 | | |
| | 6 mg/L Fe ³⁺ + 10 mg/L O ₃ + UF | 14 ± 0.12 | 14 ± 0.58 | | |
| | UF V A-C | Effluent 0.45 µm filtered | 67 ± 0.51 | 67 ± 0.89 | 73 ± 0.07 |
| | | 4 mg/L Fe ³⁺ 0.45 µm filtered | 17 ± 0.68 | 10 ± 0.38 | 16 ± 0.22 |
| 4 mg/L Fe ³⁺ + 2 mg/L O ₃ 0.45 µm filtered | | 16 ± 0.93 | 11 ± 0.49 | 17 ± 0.20 | |
| 4 mg/L Fe ³⁺ + 6 mg/L O ₃ 0.45 µm filtered | | 17 ± 0.20 | 11 ± 0.38 | 16 ± 0.41 | |
| 4 mg/L Fe ³⁺ + 10 mg/L O ₃ 0.45 µm filtered | | 19 ± 0.66 | 14 ± 0.36 | 19 ± 0.32 | |
| Effluent + UF | | 60 ± 0.39 | 61 ± 0.70 | 58 ± 0.47 | |
| 4 mg/L Fe ³⁺ 1 µm filtered | | 14 ± 0.32 | 8 ± 0.44 | 12 ± 0.54 | |
| 4 mg/L Fe ³⁺ + 2 mg/L O ₃ + UF | | 14 ± 0.34 | 8 ± 0.29 | 12 ± 0.40 | |
| 4 mg/L Fe ³⁺ + 6 mg/L O ₃ + UF | | 14 ± 0.36 | 11 ± 0.42 | 12 ± 0.23 | |
| 4 mg/L Fe ³⁺ + 10 mg/L O ₃ + UF | | 14 ± 0.74 | 10 ± 0.18 | 12 ± 0.50 | |

Table 26: PO₄-P of untreated Ruhleben secondary effluent and Ruhleben secondary effluent with 4 mg Fe³⁺/L and different ozone dosages (0-10 mg O₃/L) – results of BW trials

| Name of experiment | Sample | Trial 1 | Trial 2 | Trial 3 |
|--------------------|----------|-----------------------|-----------------------|-----------------------|
| | | Measured value [µg/L] | Measured value [µg/L] | Measured value [µg/L] |
| BW I A/C | Effluent | 94 ± 0.17 | 107 ± 0.51 | |

| | | | |
|---------------|---|-----------|------------|
| | Effluent + UF 1 st permeate | 78 ± 0.05 | 104 ± 0.36 |
| | Effluent + UF 3 rd permeate | 88 ± 0.08 | 106 ± 0.26 |
| | Effluent + UF 5 th permeate | 15 ± 0.12 | 106 ± 0.02 |
| | 4 mg/L Fe ³⁺ + 6 mg/L O ₃ | 19 ± 0.02 | 26 ± 0.17 |
| BW I B/D | 4 mg/L Fe ³⁺ + 6 mg/L O ₃ + UF 1 st permeate | 15 ± 0.20 | 17 ± 0.09 |
| | 4 mg/L Fe ³⁺ + 6 mg/L O ₃ + UF 3 rd permeate | 15 ± 0.16 | 19 ± 0.26 |
| | 4 mg/L Fe ³⁺ + 6 mg/L O ₃ + UF 5 th permeate | 93 ± 0.51 | 24 ± 0.17 |
| BW II | Effluent | 64 ± 0.58 | 66 ± 0.12 |
| | 4 mg/L Fe ³⁺ | 17 ± 0.57 | 11 ± 0.15 |
| BW II A/C | 4 mg/L Fe ³⁺ + UF 1 st permeate | 15 ± 0.42 | 9 ± 0.20 |
| | 4 mg/L Fe ³⁺ + UF 3 rd permeate | 15 ± 0.19 | 9 ± 0.21 |
| | 4 mg/L Fe ³⁺ + UF 5 th permeate | 16 ± 0.15 | 9 ± 0.09 |
| | 4 mg/L Fe ³⁺ + 6 mg/L O ₃ | 17 ± 0.06 | 12 ± 0.16 |
| BW II B/D | 4 mg/L Fe ³⁺ + 6 mg/L O ₃ + UF 1 st permeate | 15 ± 0.47 | 9 ± 0.13 |
| | 4 mg/L Fe ³⁺ + 6 mg/L O ₃ + UF 3 rd permeate | 17 ± 0.25 | 12 ± 0.11 |
| | 4 mg/L Fe ³⁺ + 6 mg/L O ₃ + UF 5 th permeate | 18 ± 0.25 | 15 ± 0.12 |
| BW III | Effluent | 66 ± 0.90 | 102 ± 0.10 |
| | 4 mg/L Fe ³⁺ | 13 ± 0.62 | 15 ± 0.31 |
| BW III A/D | 4 mg/L Fe ³⁺ + UF 1 st permeate | 12 ± 0.63 | 12 ± 0.39 |
| | 4 mg/L Fe ³⁺ + UF 3 rd permeate | 11 ± 0.18 | 12 ± 0.19 |
| | 4 mg/L Fe ³⁺ + UF 5 th permeate | 11 ± 0.07 | 12 ± 0.19 |
| BW III B/E | 4 mg/L Fe ³⁺ + 2 mg/L O ₃ | 14 ± 0.46 | 23 ± 0.24 |

| | | | |
|---------------|--|-----------|-----------|
| | 4 mg/L Fe ³⁺ + 2 mg/L O ₃ + UF 1 st permeate | 12 ± 0.53 | 12 ± 0.91 |
| | 4 mg/L Fe ³⁺ + 2 mg/L O ₃ + UF 3 rd permeate | 11 ± 0.24 | 12 ± 0.30 |
| | 4 mg/L Fe ³⁺ + 2 mg/L O ₃ + UF 5 th permeate | 12 ± 0.04 | 12 ± 0.17 |
| | 4 mg/L Fe ³⁺ + 6 mg/L O ₃ | 17 ± 0.79 | 46 ± 0.50 |
| | 4 mg/L Fe ³⁺ + 6 mg/L O ₃ + UF 1 st permeate | 13 ± 0.30 | 12 ± 0.14 |
| BW III C/F | 4 mg/L Fe ³⁺ + 6 mg/L O ₃ + UF 3 rd permeate | 13 ± 0.09 | 12 ± 0.23 |
| | 4 mg/L Fe ³⁺ + 6 mg/L O ₃ + UF 5 th permeate | 12 ± 0.31 | 12 ± 0.31 |
| | 4 mg/L Fe ³⁺ + 10 mg/L O ₃ | | 20 ± 0.33 |
| | 4 mg/L Fe ³⁺ + 10 mg/L O ₃ + UF 1 st permeate | | 12 ± 0.30 |
| BW III G | 4 mg/L Fe ³⁺ + 10 mg/L O ₃ + UF 3 rd permeate | | 12 ± 0.40 |
| | 4 mg/L Fe ³⁺ + 10 mg/L O ₃ + UF 5 th permeate | | 12 ± 0.26 |

6.3.3 DOC

Table 27: DOC of Ruhleben secondary treated effluent with different combinations of Fe³⁺-concentrations (0 - 6 mg Fe/L) and ozone dosages (0-10 mg O₃/L) – results of UF trials

| Name of experiment | Sample | Trial A | Trial B | Trial C | Mean value [mg/L] | c/c ₀ |
|---|--|-----------------------|-----------------------|-----------------------|-------------------|------------------|
| | | Measured value [mg/L] | Measured value [mg/L] | Measured value [mg/L] | | |
| UF I A-C | Effluent | 9.6 | 10.9 | | 10.4 ± 0.73 | 1.00 ± 0.01 |
| | | 9.9 | 11.1 | | | |
| | Effluent + UF | 9.6 | 10.4 | | 10.0 ± 0.44 | 0.96 ± 0.11 |
| | | 9.6 | 10.4 | | | |
| | Effluent + 10 mg/L O ₃ | 10.1 | 11.1 | | 10.6 ± 0.56 | 1.02 ± 0.12 |
| | | 10.2 | 11.1 | | | |
| | Effluent + 10 mg/L O ₃ + UF | 10.0 | 10.7 | | 10.3 ± 0.45 | 0.99 ± 0.11 |
| | | 9.9 | 10.8 | | | |
| | 2 mg/L Fe ³⁺ | 9.4 | 10.6 | | 10.0 ± 0.74 | 0.97 ± 0.14 |
| | | 9.4 | 10.7 | | | |
| | 2 mg/L Fe ³⁺ +UF | 9.3 | 10.4 | | 9.8 ± 0.66 | 0.94 ± 0.14 |
| | | 9.1 | 10.3 | | | |
| | 2 mg/L Fe ³⁺ + 10 mg/L O ₃ | 9.9 | 10.8 | | 10.3 ± 0.52 | 1.00 ± 0.12 |
| | | 9.9 | 10.8 | | | |
| | 2 mg/L Fe ³⁺ + 10 mg/L O ₃ + UF | 9.6 | 10.2 | | 9.9 ± 0.32 | 0.95 ± 0.10 |
| | | 9.6 | 10.2 | | | |
| 6 mg/L Fe ³⁺ | 8.7 | 10.2 | | 9.4 ± 0.81 | 0.91 ± 0.16 | |
| | 8.8 | 10.1 | | | | |
| 6 mg/L Fe ³⁺ +UF | 8.6 | 9.8 | | 9.2 ± 0.74 | 0.89 ± 0.15 | |
| | 8.6 | 9.9 | | | | |
| 6 mg/L Fe ³⁺ 10 mg/L O ₃ | 9.2 | 10.4 | | 9.8 ± 0.67 | 0.95 ± 0.14 | |
| | 9.3 | 10.4 | | | | |

| | | | | | | |
|--|------------------------------|------|------|------|-------------|-------------|
| | 6 mg/L Fe ³⁺ | 9.1 | 10.4 | | 9.8 ± 0.76 | 0.95 ± 0.15 |
| | 10 mg/L O ₃ + UF | 9.2 | 10.5 | | | |
| | Effluent | 10.7 | 12.1 | 10.1 | 11.0 ± 0.95 | 1.00 ± 0.01 |
| | | 10.9 | 12.3 | 10.1 | | |
| | Effluent + UF | 10.7 | 11.7 | 9.7 | 10.7 ± 0.91 | 0.97 ± 0.17 |
| | | 10.6 | 11.8 | 9.7 | | |
| | Effluent + | 11.2 | 12.3 | 10.2 | 11.2 ± 0.96 | 1.01 ± 0.17 |
| | 2mg/L O ₃ | 11.0 | 12.3 | 10.1 | | |
| | Effluent + | 11.0 | 11.9 | 9.8 | 10.9 ± 0.93 | 0.98 ± 0.17 |
| | 2mg/L O ₃ + UF | 10.8 | 11.9 | 9.8 | | |
| | 2 mg/L Fe ³⁺ | 10.7 | 11.8 | 9.8 | 10.8 ± 0.89 | 0.98 ± 0.17 |
| | | 10.9 | 11.8 | 9.9 | | |
| | 2 mg/L Fe ³⁺ +UF | 10.3 | 11.4 | 9.5 | 10.4 ± 0.88 | 0.94 ± 0.17 |
| | | 10.2 | 11.4 | 9.5 | | |
| | 2 mg/L Fe ³⁺ + | 10.7 | 12.1 | 9.8 | 10.8 ± 1.03 | 0.98 ± 0.18 |
| | 2mg/L O ₃ | 10.5 | 12.0 | 9.8 | | |
| | 2 mg/L Fe ³⁺ + | 10.6 | 11.9 | 9.6 | 10.6 ± 1.05 | 0.96 ± 0.18 |
| | 2mg/L O ₃ + UF | 10.4 | 11.9 | 9.5 | | |
| | 6 mg/L Fe ³⁺ | 9.9 | 11.3 | 9.1 | 10.1 ± 0.97 | 0.92 ± 0.18 |
| | | 10.0 | 11.3 | 9.1 | | |
| | 6 mg/L Fe ³⁺ +UF | 9.9 | 11.2 | 8.8 | 9.9 ± 1.06 | 0.90 ± 0.19 |
| | | 9.8 | 11.1 | 8.8 | | |
| | 6 mg/L Fe ³⁺ | 10.2 | 11.1 | 9.3 | 10.2 ± 0.80 | 0.93 ± 0.16 |
| | 2mg/L O ₃ | 10.3 | 11.1 | 9.4 | | |
| | 6 mg/L Fe ³⁺ | 10.0 | 11.5 | 9.2 | 10.0 ± 0.87 | 0.91 ± 0.17 |
| | 2mg/L O ₃ + UF | 9.8 | 10.5 | 9.1 | | |
| | Effluent | 9.6 | 11.9 | | 10.9 ± 1.38 | 1.00 ± 0.01 |
| | | 9.8 | 12.1 | | | |
| | Effluent + UF | 9.3 | 10.9 | | 10.1 ± 0.90 | 0.93 ± 0.22 |
| | | 9.4 | 11.0 | | | |
| | 2 mg/L Fe ³⁺ | 9.6 | 11.2 | | 10.4 ± 1.01 | 0.96 ± 0.22 |
| | | 9.4 | 11.3 | | | |
| | 2 mg/L Fe ³⁺ +UF | 9.4 | 11.6 | | 10.4 ± 1.30 | 0.96 ± 0.25 |
| | | 9.2 | 11.5 | | | |
| | 2 mg/L Fe ³⁺ + | 9.6 | 12.5 | | 11.0 ± 1.64 | 1.02 ± 0.28 |
| | 2mg/L O ₃ | 9.6 | 12.4 | | | |
| | 2 mg/L Fe ³⁺ + 2 | 9.4 | 10.8 | | 10.1 ± 0.84 | 0.93 ± 0.21 |
| | mg/L O ₃ + UF | 9.4 | 10.9 | | | |
| | 2 mg/L Fe ³⁺ + 4 | 9.6 | 13.8 | | 11.7 ± 2.39 | 1.08 ± 0.33 |
| | mg/L O ₃ | 9.7 | 13.8 | | | |
| | 2 mg/L Fe ³⁺ + 4 | 9.4 | 11.3 | | 10.3 ± 1.11 | 0.95 ± 0.23 |
| | mg/L O ₃ + UF | 9.3 | 11.2 | | | |
| | 2 mg/L Fe ³⁺ + 6 | 9.6 | 14.2 | | 12.0 ± 2.73 | 1.10 ± 0.35 |
| | mg/L O ₃ | 9.6 | 14.4 | | | |
| | 2 mg/L Fe ³⁺ + 6 | 9.5 | 12.2 | | 10.8 ± 1.55 | 0.99 ± 0.27 |
| | mg/L O ₃ + UF | 9.4 | 12.1 | | | |
| | 2 mg/L Fe ³⁺ + 8 | 9.6 | 12.2 | | 10.8 ± 1.43 | 1.00 ± 0.26 |
| | mg/L O ₃ | 9.6 | 12.0 | | | |
| | 2 mg/L Fe ³⁺ + 8 | 9.4 | 10.8 | | 10.1 ± 0.79 | 0.93 ± 0.21 |
| | mg/L O ₃ + UF | 9.3 | 10.7 | | | |
| | 2 mg/L Fe ³⁺ + 10 | 9.6 | 12.6 | | 11.1 ± 1.80 | 1.02 ± 0.29 |
| | mg/L O ₃ | 9.4 | 12.7 | | | |
| | 2 mg/L Fe ³⁺ + 10 | 9.5 | 10.9 | | 10.2 ± 0.75 | 0.94 ± 0.20 |
| | mg/L O ₃ + UF | 9.6 | 10.8 | | | |
| | Effluent | 10.7 | 10.8 | | 10.9 ± 0.15 | 1.00 ± 0.00 |
| | | 11.1 | 10.9 | | | |
| | Effluent + UF | 10.6 | 10.5 | | 10.5 ± 0.06 | 0.97 ± 0.02 |
| | | 10.6 | 10.6 | | | |
| | 6 mg/L Fe ³⁺ | 10.2 | 10.2 | | 10.2 ± 0.06 | 0.94 ± 0.02 |
| | | 10.3 | 10.2 | | | |
| | 6 mg/L Fe ³⁺ +UF | 9.9 | 9.8 | | 9.9 ± 0.12 | 0.91 ± 0.03 |
| | | 10.0 | 9.7 | | | |
| | 6 mg/L Fe ³⁺ + | 10.2 | 10.4 | | 10.3 ± 0.09 | 0.95 ± 0.02 |
| | 2 mg/L O ₃ | 10.3 | 10.2 | | | |
| | 6 mg/L Fe ³⁺ + | 9.9 | 9.9 | | 10.0 ± 0.18 | 0.92 ± 0.03 |
| | 2 mg/L O ₃ + UF | 10.3 | 9.9 | | | |

| | | | | | | |
|-----------------------------|-----------------------------|------|------|-------------|-------------|-------------|
| | 6 mg/L Fe ³⁺ + | 10.4 | 10.3 | | 10.3 ± 0.12 | 0.95 ± 0.03 |
| | 6 mg/L O ₃ | 10.5 | 10.2 | | | |
| | 6 mg/L Fe ³⁺ | 10.0 | 10.0 | | 10.0 ± 0.02 | 0.92 ± 0.02 |
| | 6 mg/L O ₃ + UF | 10.0 | 10.0 | | | |
| | 6 mg/L Fe ³⁺ + | 10.4 | 10.2 | | 10.3 ± 0.07 | 0.94 ± 0.02 |
| | 10 mg/L O ₃ | 10.3 | 10.2 | | | |
| | 6 mg/L Fe ³⁺ + | 10.1 | 10.1 | | 10.1 ± 0.03 | 0.92 ± 0.02 |
| | 10 mg/L O ₃ + UF | 10.1 | 10.0 | | | |
| UF V A-C | Effluent | 10.8 | 11.4 | 11.2 | 11.2 ± 0.27 | 1.00 ± 0.00 |
| | | 11.0 | 11.5 | 11.1 | | |
| | Effluent + UF | 10.7 | 11.1 | 10.7 | 10.8 ± 0.19 | 0.97 ± 0.04 |
| | | 10.7 | 11.0 | 10.7 | | |
| | 4 mg/L Fe ³⁺ | 10.5 | 10.8 | 10.3 | 10.5 ± 0.22 | 0.94 ± 0.04 |
| | | 10.5 | 10.8 | 10.4 | | |
| | 4 mg/L Fe ³⁺ +UF | 10.2 | 10.7 | 10.1 | 10.3 ± 0.23 | 0.92 ± 0.05 |
| | | 10.2 | 10.5 | 10.1 | | |
| | 4 mg/L Fe ³⁺ + | 10.6 | 11.0 | 10.6 | 10.7 ± 0.24 | 0.96 ± 0.05 |
| | 2 mg/L O ₃ | 10.5 | 11.1 | 10.6 | | |
| | 4 mg/L Fe ³⁺ + | 10.2 | 10.6 | 10.2 | 10.4 ± 0.26 | 0.93 ± 0.05 |
| | 2 mg/L O ₃ + UF | 10.4 | 10.8 | 10.2 | | |
| | 4 mg/L Fe ³⁺ + | 10.6 | 11.1 | 10.8 | 10.8 ± 0.26 | 0.97 ± 0.05 |
| | 6 mg/L O ₃ | 10.5 | 11.2 | 10.8 | | |
| | 4 mg/L Fe ³⁺ + | 10.3 | 10.9 | 10.4 | 10.5 ± 0.21 | 0.94 ± 0.04 |
| | 6 mg/L O ₃ + UF | 10.4 | 10.6 | 10.4 | | |
| 4 mg/L Fe ³⁺ + | 10.6 | 10.6 | 10.9 | 10.7 ± 0.14 | 0.96 ± 0.04 | |
| 10 mg/L O ₃ | 10.5 | 10.7 | 10.8 | | | |
| 4 mg/L Fe ³⁺ + | 10.3 | 10.3 | 10.4 | 10.4 ± 0.08 | 0.93 ± 0.03 | |
| 10 mg/L O ₃ + UF | 10.4 | 10.4 | 10.5 | | | |

Table 28: DOC of untreated Ruhleben secondary effluent and Ruhleben secondary effluent with 4 mg Fe³⁺/L and different ozone dosages (0-10 mg O₃/L) – results of BW trials

| Name of experiment | Sample | Trial 1 | Trial 2 | Trial 3 | Mean value [mg/L] | c/c ₀ |
|--|--|-----------------------|-----------------------|-----------------------|-------------------|------------------|
| | | Measured value [mg/L] | Measured value [mg/L] | Measured value [mg/L] | | |
| BW I A/C | Effluent | 11.8 | 14.5 | | 12.7 ± 1.24 | 1.00 ± 0.01 |
| | | 12.1 | 12.3 | | | |
| | Effluent + UF 1 st permeate | 11.7 | 10.3 | | 11.0 ± 0.73 | 0.86 ± 0.16 |
| | | 11.5 | 10.4 | | | |
| BW I B/D | Effluent + UF 3 rd permeate | 11.8 | 10.3 | | 11.0 ± 0.83 | 0.87 ± 0.17 |
| | | 11.7 | 10.3 | | | |
| | Effluent + UF 5 th permeate | 11.7 | 10.4 | | 11.0 ± 0.80 | 0.87 ± 0.17 |
| | | 11.7 | 10.3 | | | |
| BW I B/D | 4 mg/L Fe ³⁺ + | 11.3 | 10.4 | | 10.8 ± 0.56 | 0.85 ± 0.15 |
| | 6 mg/L O ₃ | 11.3 | 10.3 | | | |
| | 4 mg/L Fe ³⁺ + | 11.3 | 10.0 | | 10.6 ± 0.81 | 0.84 ± 0.17 |
| | 6 mg/L O ₃ + UF 1 st permeate | 11.4 | 10.0 | | | |
| | 4 mg/L Fe ³⁺ + | 11.4 | 10.1 | | 10.7 ± 0.70 | 0.84 ± 0.16 |
| 6 mg/L O ₃ + UF 3 rd permeate | 11.2 | 10.0 | | | | |
| BW II | 4 mg/L Fe ³⁺ + | 11.6 | 10.1 | 10.8 | 10.8 ± 0.88 | 0.85 ± 0.18 |
| | 6 mg/L O ₃ + UF 5 th permeate | 11.5 | 10.0 | 10.7 | | |
| BW II | Effluent | | 8.8 | 10.8 | 9.8 ± 1.06 | 1.00 ± 0.01 |
| | | | 9.0 | 10.7 | | |

| | | | | | |
|---------------|---|--------------|--------------|-------------|-------------|
| BW II A/C | 4 mg/L Fe ³⁺ | 8.1 8.2 | 10.3 10.1 | 9.2 ± 1.20 | 0.93 ± 0.24 |
| | 4 mg/L Fe ³⁺ + UF 1 st permeate | 7.9 8.0 | 9.5 9.6 | 8.7 ± 0.92 | 0.89 ± 0.21 |
| | 4 mg/L Fe ³⁺ + UF 3 rd permeate | 8.1 8.0 | 9.8 9.8 | 8.9 ± 0.99 | 0.91 ± 0.22 |
| | 4 mg/L Fe ³⁺ + UF 5 th permeate | 8.5 8.5 | 9.9 10.1 | 9.3 ± 0.86 | 0.94 ± 0.20 |
| BW II B/D | 4 mg/L Fe ³⁺ + 6 mg/L O ₃ | 8.7 8.5 | 10.3 10.1 | 9.4 ± 0.95 | 0.96 ± 0.21 |
| | 4 mg/L Fe ³⁺ + 6 mg/L O ₃ + UF 1 st permeate | 8.2 8.4 | 10.0 9.8 | 9.1 ± 0.94 | 0.93 ± 0.21 |
| | 4 mg/L Fe ³⁺ + 6 mg/L O ₃ + UF 3 rd permeate | 8.3 8.3 | 10.2 10.0 | 9.2 ± 1.04 | 0.94 ± 0.22 |
| | 4 mg/L Fe ³⁺ + 6 mg/L O ₃ + UF 5 th permeate | 8.8 8.7 | 10.2 10.2 | 9.5 ± 0.82 | 0.97 ± 0.19 |
| BW III | Effluent | 11.1 10.6 | 10.8 10.9 | 10.9 ± 0.21 | 1.00 ± 0.00 |
| BW III A/D | 4 mg/L Fe ³⁺ | 10.6 10.5 | 10.3 9.4 | 10.2 ± 0.54 | 0.94 ± 0.07 |
| | 4 mg/L Fe ³⁺ + UF 1 st permeate | 10.2 10.2 | 9.8 9.8 | 10.0 ± 0.22 | 0.92 ± 0.04 |
| | 4 mg/L Fe ³⁺ + UF 3 rd permeate | 10.5 10.4 | 10.0 10.1 | 10.3 ± 0.25 | 0.95 ± 0.04 |
| | 4 mg/L Fe ³⁺ + UF 5 th permeate | 10.5 10.5 | 10.1 10.1 | 10.3 ± 0.22 | 0.95 ± 0.04 |
| BW III B/E | 4 mg/L Fe ³⁺ + 2 mg/L O ₃ | 10.7 10.9 | 10.4 10.3 | 10.6 ± 0.24 | 0.98 ± 0.04 |
| | 4 mg/L Fe ³⁺ + 2 mg/L O ₃ + UF 1 st permeate | 10.5 10.4 | 10.0 9.9 | 10.2 ± 0.30 | 0.94 ± 0.05 |
| | 4 mg/L Fe ³⁺ + 2 mg/L O ₃ + UF 3 rd permeate | 10.5 10.6 | 9.9 10.0 | 10.2 ± 0.32 | 0.94 ± 0.05 |
| | 4 mg/L Fe ³⁺ + 2 mg/L O ₃ + UF 5 th permeate | 10.5 10.5 | 10.2 10.1 | 10.3 ± 0.20 | 0.95 ± 0.04 |
| BW III C/F | 4 mg/L Fe ³⁺ + 6 mg/L O ₃ | 10.9 10.8 | 10.6 10.5 | 10.7 ± 0.19 | 0.98 ± 0.04 |
| | 4 mg/L Fe ³⁺ + 6 mg/L O ₃ + UF 1 st permeate | 10.6 10.5 | 9.9 9.9 | 10.2 ± 0.37 | 0.94 ± 0.06 |
| | 4 mg/L Fe ³⁺ + 6 mg/L O ₃ + UF 3 rd permeate | 10.6 10.4 | 10.0 10.0 | 10.3 ± 0.29 | 0.95 ± 0.05 |
| | 4 mg/L Fe ³⁺ + 6 mg/L O ₃ + UF 5 th permeate | 10.5 10.5 | 10.0 9.9 | 10.2 ± 0.29 | 0.94 ± 0.05 |
| BW III G | 4 mg/L Fe ³⁺ + 10 mg/L O ₃ | | 10.4 10.4 | 10.4 ± 0.01 | 0.96 ± 0.02 |

| | | | |
|---|------|-------------|-------------|
| 4 mg/L Fe ³⁺ + | 9.9 | | |
| 10 mg/L O ₃ + UF 1 st permeate | 10.0 | 9.9 ± 0.08 | 0.91 ± 0.03 |
| 4 mg/L Fe ³⁺ + | 10.1 | | |
| 10 mg/L O ₃ + UF 3 rd permeate | 10.1 | 10.1 ± 0.06 | 0.93 ± 0.03 |
| 4 mg/L Fe ³⁺ + | 10.2 | | |
| 10 mg/L O ₃ + UF 5 th permeate | 10.2 | 10.2 ± 0.01 | 0.94 ± 0.02 |

6.3.4 Residual Iron

Table 29: Residual iron of Ruhleben secondary treated effluent with different combinations of Fe³⁺- concentrations (0 - 6 mg Fe/L) and ozone dosages (0-10 mg O₃/L) – results of UF trials

| Name of experiment | Sample | Trial A | Trial B | Trial C |
|--------------------|---|-----------------------|-----------------------|-----------------------|
| | | Measured value [µg/L] | Measured value [µg/L] | Measured value [µg/L] |
| UF I A-C | Effluent 0.45 µm filtered | 16.9 ± 1.4 | 24.9 ± 0.8 | 22.4 ± 5.5 |
| | 2 mg/L Fe ³⁺ 0.45 µm filtered | 40.6 ± 3.5 | 258.3 ± 20.9 | 50.4 ± 8.0 |
| | 6 mg/L Fe ³⁺ 0.45 µm filtered | 22.7 ± 1.0 | 87.4 ± 0.2 | 23.5 ± 3.1 |
| | Effluent + 10 mg/L O ₃ 0.45 µm filtered | 9.9 ± 0.5 | 19.6 ± 0.6 | 23.6 ± 2.4 |
| | 2 mg/L Fe ³⁺ + 10 mg/L O ₃ 0.45 µm filtered | 62.3 ± 0.9 | 212.1 ± 26.7 | 64.2 ± 6.3 |
| | 6 mg/L Fe ³⁺ 10 mg/L O ₃ 0.45 µm filtered | 60.1 ± 1.0 | 138.6 ± 1.1 | 73.4 ± 1.8 |
| | Effluent 0.2 µm filtered | 14.4 ± 0.6 | 21.4 ± 1.2 | 338.0 ± 106.5 |
| | 2 mg/L Fe ³⁺ 0.2 µm filtered | 33.5 ± 1.4 | 47.5 ± 0.2 | 83.1 ± 2.1 |
| | 6 mg/L Fe ³⁺ 0.2 µm filtered | 20.6 ± 0.6 | 53.3 ± 0.9 | 184.6 ± 1.5 |
| | Effluent + 10 mg/L O ₃ 0.2 µm filtered | 11.9 ± 1.0 | 18.7 ± 0.7 | 32.1 ± 5.6 |
| | 2 mg/L Fe ³⁺ + 10 mg/L O ₃ 0.2 µm filtered | 30.9 ± 0.6 | 40.7 ± 0.7 | 53.4 ± 6.4 |
| | 6 mg/L Fe ³⁺ 10 mg/L O ₃ 0.2 µm filtered | 22.0 ± 0.4 | 20.0 ± 0.3 | 54.3 ± 1.3 |
| | Effluent + UF | 16.7 ± 0.8 | 19.9 ± 0.3 | 32.2 ± 1.1 |
| | Effluent + 10 mg/L O ₃ + UF | 12.7 ± 0.7 | 14.9 ± 0.2 | 29.1 ± 1.9 |
| | 2 mg/L Fe ³⁺ +UF | 7.0 ± 0.5 | 11.5 ± 0.1 | 24.8 ± 2.1 |

| | | | | |
|---------------|--|--------------|-------------|-------------|
| | 2 mg/L Fe ³⁺ + 10 mg/L O ₃ + UF | 8.7 ± 0.5 | 12.1 ± 0.4 | 22.4 ± 0.6 |
| | 6 mg/L Fe ³⁺ +UF | 7.5 ± 1.0 | 12.9 ± 0.2 | 27.3 ± 1.0 |
| | 6 mg/L Fe ³⁺ 10 mg/L O ₃ + UF | 6.7 ± 0.7 | 8.2 ± 0.2 | 21.8 ± 4.2 |
| | Effluent 0.45 µm filtered | 25.1 ± 1.3 | 39.8 ± 8.7 | 20.2 ± 4.9 |
| | 2 mg/L Fe ³⁺ 0.45 µm filtered | 108.8 ± 1.7 | 67.8 ± 0.3 | 156.2 ± 6.9 |
| | 6 mg/L Fe ³⁺ 0.45 µm filtered | 26.7 ± 1.1 | 72.7 ± 0.8 | 355.8 ± 6.4 |
| | Effluent + 2mg/L O ₃ 0.45 µm filtered | 20.9 ± 0.2 | 35.0 ± 2.5 | 29.4 ± 1.3 |
| | 2 mg/L Fe ³⁺ + 2mg/L O ₃ 0.45 µm filtered | 356.8 ± 40.2 | 130.4 ± 1.4 | 173.4 ± 7.3 |
| | 6 mg/L Fe ³⁺ 2mg/L O ₃ 0.45 µm filtered | 44.3 ± 0.9 | 109.2 ± 0.9 | 261.6 ± 1.6 |
| | Effluent 0.2 µm filtered | 25.4 ± 0.7 | 41.7 ± 0.8 | |
| | 2 mg/L Fe ³⁺ 0.2 µm filtered | 46.0 ± 1.4 | 57.6 ± 1.2 | |
| | 6 mg/L Fe ³⁺ 0.2 µm filtered | 56.3 ± 1.2 | 77.2 ± 0.6 | |
| UF II A-C | Effluent + 2mg/L O ₃ 0.2 µm filtered | 23.3 ± 1.4 | 37.0 ± 1.5 | |
| | 2 mg/L Fe ³⁺ + 2mg/L O ₃ 0.2 µm filtered | 72.7 ± 0.5 | 91.9 ± 1.3 | |
| | 6 mg/L Fe ³⁺ 2mg/L O ₃ 0.2 µm filtered | 21.9 ± 0.5 | 74.6 ± 0.1 | |
| | Effluent + UF | 21.6 ± 1.4 | 30.3 ± 1.1 | 30.3 ± 5.1 |
| | 2 mg/L Fe ³⁺ +UF | 15.4 ± 0.7 | 32.1 ± 2.7 | 24.0 ± 2.7 |
| | 6 mg/L Fe ³⁺ +UF | 13.6 ± 0.4 | 32.8 ± 11.3 | 23.5 ± 2.0 |
| | Effluent + 2mg/L O ₃ + UF | 21.4 ± 1.2 | 27.0 ± 1.1 | 24.4 ± 0.2 |
| | 2 mg/L Fe ³⁺ + 2mg/L O ₃ + UF | 10.4 ± 0.2 | 23.0 ± 0.4 | 23.2 ± 2.5 |
| | 6 mg/L Fe ³⁺ 2mg/L O ₃ + UF | 8.7 ± 0.3 | 22.5 ± 2.7 | 13.2 ± 2.7 |
| UF III A-B | Effluent 0.45 µm filtered | 39.3 ± 2.6 | 41.1 ± 1.0 | |

| | | | |
|--------------|---|-------------|-------------|
| | 2 mg/L Fe ³⁺ 0.45 µm filtered | 74.8 ± 0.4 | 100.6 ± 1.6 |
| | 2 mg/L Fe ³⁺ + 2mg/L O ₃ 0.45 µm filtered | 81.3 ± 1.6 | 93.6 ± 0.9 |
| | 2 mg/L Fe ³⁺ + 4 mg/L O ₃ 0.45 µm filtered | 102.7 ± 2.3 | 89.0 ± 2.0 |
| | 2 mg/L Fe ³⁺ + 6 mg/L O ₃ 0.45 µm filtered | 103.2 ± 0.4 | 100.0 ± 2.2 |
| | 2 mg/L Fe ³⁺ + 8 mg/L O ₃ 0.45 µm filtered | 69.6 ± 0.6 | 65.9 ± 0.9 |
| | 2 mg/L Fe ³⁺ + 10 mg/L O ₃ 0.45 µm filtered | 154.2 ± 8.6 | 96.3 ± 0.8 |
| | Effluent 0.2 µm filtered | 32.0 ± 1.1 | 39.1 ± 2.3 |
| | 2 mg/L Fe ³⁺ 0.2 µm filtered | 34.7 ± 1.8 | 60.1 ± 0.3 |
| | 2 mg/L Fe ³⁺ + 2mg/L O ₃ 0.2 µm filtered | 66.8 ± 1.0 | 59.3 ± 3.1 |
| | 2 mg/L Fe ³⁺ + 4 mg/L O ₃ 0.2 µm filtered | 54.4 ± 0.9 | 64.9 ± 0.3 |
| | 2 mg/L Fe ³⁺ + 6 mg/L O ₃ 0.2 µm filtered | 40.6 ± 0.8 | 53.0 ± 0.5 |
| | 2 mg/L Fe ³⁺ + 8 mg/L O ₃ 0.2 µm filtered | 40.9 ± 0.8 | 56.0 ± 1.5 |
| | 2 mg/L Fe ³⁺ + 10 mg/L O ₃ 0.2 µm filtered | 90.5 ± 0.5 | 76.5 ± 0.9 |
| | Effluent + UF | 34.5 ± 1.6 | 24.5 ± 1.1 |
| | 2 mg/L Fe ³⁺ +UF | 34.3 ± 3.2 | 24.3 ± 0.9 |
| | 2 mg/L Fe ³⁺ + 2 mg/L O ₃ + UF | 27.3 ± 1.0 | 19.2 ± 0.4 |
| | 2 mg/L Fe ³⁺ + 4 mg/L O ₃ + UF | 31.0 ± 1.4 | 17.4 ± 1.1 |
| | 2 mg/L Fe ³⁺ + 6 mg/L O ₃ + UF | 28.2 ± 2.1 | 17.2 ± 0.5 |
| | 2 mg/L Fe ³⁺ + 8 mg/L O ₃ + UF | 47.4 ± 1.1 | 21.6 ± 0.3 |
| | 2 mg/L Fe ³⁺ + 10 mg/L O ₃ + UF | 48.7 ± 0.4 | 27.2 ± 1.6 |
| UF IV A-B | Effluent 0.45 µm filtered | 47.4 ± 0.8 | 37.1 ± 0.4 |
| | 6 mg/L Fe ³⁺ 0.45 µm filtered | | 64.3 ± 2.9 |

| | | | | |
|-------------|---|-------------|-------------|--------------|
| | 6 mg/L Fe ³⁺ + 2 mg/L O ₃ 0.45 µm filtered | 49.3 ± 1.3 | 47.5 ± 0.4 | |
| | 6 mg/L Fe ³⁺ + 6 mg/L O ₃ 0.45 µm filtered | 45.5 ± 1.0 | 65.8 ± 0.1 | |
| | 6 mg/L Fe ³⁺ + 10 mg/L O ₃ 0.45 µm filtered | 278.1 ± 7.5 | 83.5 ± 1.8 | |
| | Effluent 0.2 µm filtered | 49.8 ± 0.4 | 32.7 ± 2.0 | |
| | 6 mg/L Fe ³⁺ 0.2 µm filtered | 141.0 ± 3.4 | 68.2 ± 0.5 | |
| | 6 mg/L Fe ³⁺ + 2 mg/L O ₃ 0.2 µm filtered | 97.0 ± 1.6 | 51.8 ± 0.4 | |
| | 6 mg/L Fe ³⁺ + 6 mg/L O ₃ 0.2 µm filtered | 107.2 ± 6.2 | 188.0 ± 4.5 | |
| | 6 mg/L Fe ³⁺ + 10 mg/L O ₃ 0.2 µm filtered | 142.8 ± 2.3 | 180.2 ± 3.2 | |
| | Effluent + UF | 65.4 ± 2.1 | 30.9 ± 1.1 | |
| | 6 mg/L Fe ³⁺ + UF | 43.1 ± 5.1 | 25.4 ± 1.6 | |
| | 6 mg/L Fe ³⁺ + 2 mg/L O ₃ + UF | 32.4 ± 1.4 | 34.0 ± 0.2 | |
| | 6 mg/L Fe ³⁺ + 6 mg/L O ₃ + UF | 28.9 ± 0.5 | 23.5 ± 3.1 | |
| | 6 mg/L Fe ³⁺ + 10 mg/L O ₃ + UF | 46.5 ± 0.1 | 39.2 ± 2.9 | |
| | Effluent 0.45 µm filtered | 41.3 ± 0.2 | 35.4 ± 1.7 | 34.2 ± 0.4 |
| | 4 mg/L Fe ³⁺ 0.45 µm filtered | 109.0 ± 2.3 | 43.7 ± 0.1 | 87.5 ± 0.1 |
| | 4 mg/L Fe ³⁺ + 2 mg/L O ₃ 0.45 µm filtered | 76.7 ± 0.8 | 56.9 ± 0.1 | 209.8 ± 8.0 |
| UF V A-C | 4 mg/L Fe ³⁺ + 6 mg/L O ₃ 0.45 µm filtered | 92.0 ± 1.6 | 62.9 ± 2.5 | 159.0 ± 7.3 |
| | 4 mg/L Fe ³⁺ + 10 mg/L O ₃ 0.45 µm filtered | 184.4 ± 0.0 | 86.2 ± 3.6 | 179.2 ± 24.7 |
| | Effluent 0.2 µm filtered | 47.9 ± 0.0 | 32.8 ± 1.0 | |
| | 4 mg/L Fe ³⁺ 0.2 µm filtered | 70.0 ± 1.1 | 61.2 ± 0.7 | |
| | 4 mg/L Fe ³⁺ + 2 mg/L O ₃ 0.2 µm filtered | 219.8 ± 3.1 | 87.7 ± 0.6 | |
| | 4 mg/L Fe ³⁺ + 6 mg/L O ₃ 0.2 µm filtered | 77.8 ± 1.7 | 65.7 ± 0.1 | |

| | | | |
|--|-------------|------------|------------|
| 4 mg/L Fe ³⁺ + 10 mg/L O ₃ 0.2 µm filtered | 178.4 ± 1.4 | 65.5 ± 2.0 | |
| Effluent + UF | 31.8 ± 1.3 | 34.8 ± 1.7 | 95.9 ± 1.3 |
| 4 mg/L Fe ³⁺ 1 µm filtered | 34.3 ± 0.4 | 22.8 ± 1.7 | 91.5 ± 1.3 |
| 4 mg/L Fe ³⁺ + 2 mg/L O ₃ + UF | 22.2 ± 0.1 | 19.8 ± 1.6 | 96.0 ± 1.8 |
| 4 mg/L Fe ³⁺ + 6 mg/L O ₃ + UF | 30.6 ± 0.2 | 23.5 ± 1.2 | 94.2 ± 0.0 |
| 4 mg/L Fe ³⁺ + 10 mg/L O ₃ + UF | 26.2 ± 1.9 | 34.4 ± 1.4 | 94.2 ± 1.3 |

Table 30: Residual iron of untreated Ruhleben secondary effluent and Ruhleben secondary effluent with 4 mg Fe³⁺/L and different ozone dosages (0-10 mg O₃/L) – results of BW trials

| Name of experiment | Sample | Trial 1 | Trial 2 | Trial 3 |
|--------------------|---|-----------------------|-----------------------|-----------------------|
| | | Measured value [µg/L] | Measured value [µg/L] | Measured value [µg/L] |
| BW I A/C | Effluent 0.45 µm filtered | 89.0 ± 1.1 | 39.2 ± 0.0 | |
| | Effluent 0.2 µm filtered | 46.0 ± 0.8 | 34.1 ± 0.3 | |
| | Effluent + UF 1 st permeate | 88.3 ± 0.2 | 39.9 ± 0.9 | |
| | Effluent + UF 3 rd permeate | 89.1 ± 0.2 | 33.4 ± 0.1 | |
| | Effluent + UF 5 th permeate | 58.7 ± 0.9 | 36.1 ± 0.4 | |
| BW I B/D | 4 mg/L Fe ³⁺ + 6 mg/L O ₃ 0.45 µm filtered | 106.0 ± 0.1 | 159.4 ± 3.5 | |
| | 4 mg/L Fe ³⁺ + 6 mg/L O ₃ 0.2 µm filtered | 60.7 ± 0.6 | 138.0 ± 4.1 | |
| | 4 mg/L Fe ³⁺ + 6 mg/L O ₃ + UF 1 st permeate | 46.2 ± 0.6 | 21.7 ± 0.8 | |
| | 4 mg/L Fe ³⁺ + 6 mg/L O ₃ + UF 3 rd permeate | 64.8 ± 0.1 | 30.4 ± 1.1 | |
| | 4 mg/L Fe ³⁺ + 6 mg/L O ₃ + UF 5 th permeate | 37.4 ± 0.5 | 29.7 ± 1.2 | |
| BW II | Effluent 0.45 µm filtered | | 22.3 ± 0.4 | 22.7 ± 1.2 |
| | Effluent 0.2 µm filtered | | 21.3 ± 0.7 | 33.4 ± 0.4 |
| BW II A/C | 4 mg/L Fe ³⁺ 0.45 µm filtered | | 72.8 ± 0.8 | 189.2 ± 1.1 |

| | | | |
|---------------|---|-------------|--------------|
| | 4 mg/L Fe ³⁺ 0.2 µm filtered | 51.0 ± 2.1 | 54.1 ± 3.4 |
| | 4 mg/L Fe ³⁺ + UF 1 st permeate | 16.2 ± 0.1 | 23.9 ± 0.7 |
| | 4 mg/L Fe ³⁺ + UF 3 rd permeate | 11.2 ± 0.3 | 22.8 ± 0.8 |
| | 4 mg/L Fe ³⁺ + UF 5 th permeate | 12.2 ± 0.6 | 15.9 ± 0.0 |
| | 4 mg/L Fe ³⁺ + 6 mg/L O ₃ 0.45 µm filtered | 55.2 ± 0.4 | 36.8 ± 3.1 |
| | 4 mg/L Fe ³⁺ + 6 mg/L O ₃ 0.2 µm filtered | 44.8 ± 0.3 | 42.2 ± 2.9 |
| BW II B/D | 4 mg/L Fe ³⁺ + 6 mg/L O ₃ + UF 1 st permeate | 10.8 ± 0.2 | 18.2 ± 1.3 |
| | 4 mg/L Fe ³⁺ + 6 mg/L O ₃ + UF 3 rd permeate | 24.0 ± 0.6 | 17.0 ± 0.4 |
| | 4 mg/L Fe ³⁺ + 6 mg/L O ₃ + UF 5 th permeate | 10.9 ± 0.3 | 16.0 ± 0.7 |
| BW III | Effluent 0.45 µm filtered | 43.5 ± 2.0 | 40.6 ± 0.7 |
| | Effluent 0.2 µm filtered | 55.9 ± 1.8 | 35.3 ± 0.5 |
| | 4 mg/L Fe ³⁺ 0.45 µm filtered | 138.8 ± 3.9 | 207.4 ± 8.7 |
| | 4 mg/L Fe ³⁺ 0.2 µm filtered | 44.6 ± 1.0 | 86.7 ± 3.2 |
| BW III A/D | 4 mg/L Fe ³⁺ + UF 1 st permeate | 31.0 ± 0.1 | 35.4 ± 5.5 |
| | 4 mg/L Fe ³⁺ + UF 3 rd permeate | 27.8 ± 1.1 | 31.7 ± 3.6 |
| | 4 mg/L Fe ³⁺ + UF 5 th permeate | 22.6 ± 3.8 | 30.0 ± 0.9 |
| | 4 mg/L Fe ³⁺ + 2 mg/L O ₃ 0.45 µm filtered | 67.9 ± 4.8 | 166.4 ± 2.0 |
| | 4 mg/L Fe ³⁺ + 2 mg/L O ₃ 0.2 µm filtered | 93.5 ± 1.0 | 144.0 ± 12.7 |
| BW III B/E | 4 mg/L Fe ³⁺ + 2 mg/L O ₃ + UF 1 st permeate | 51.0 ± 0.2 | 175.6 ± 0.0 |
| | 4 mg/L Fe ³⁺ + 2 mg/L O ₃ + UF 3 rd permeate | 49.7 ± 1.0 | 37.7 ± 1.5 |
| | 4 mg/L Fe ³⁺ + 2 mg/L O ₃ + UF 5 th permeate | 54.7 ± 0.9 | 26.8 ± 0.6 |
| BW III C/F | 4 mg/L Fe ³⁺ + 6 mg/L O ₃ 0.45 µm filtered | 95.9 ± 1.6 | 417.6 ± 13.4 |

| | | | |
|-------------|--|------------|-------------|
| | 4 mg/L Fe ³⁺ + 6 mg/L O ₃ 0.2 µm filtered | 49.4 ± 0.9 | 169.4 ± 3.7 |
| | 4 mg/L Fe ³⁺ + 6 mg/L O ₃ + UF 1 st permeate | 31.7 ± 1.6 | 38.3 ± 2.1 |
| | 4 mg/L Fe ³⁺ + 6 mg/L O ₃ + UF 3 rd permeate | 18.1 ± 1.6 | 35.7 ± 0.8 |
| | 4 mg/L Fe ³⁺ + 6 mg/L O ₃ + UF 5 th permeate | 19.5 ± 0.2 | 21.6 ± 0.7 |
| | 4 mg/L Fe ³⁺ + 10 mg/L O ₃ 0.45 µm filtered | | 306.4 ± 9.8 |
| | 4 mg/L Fe ³⁺ + 10 mg/L O ₃ 0.2 µm filtered | | 169.0 ± 5.7 |
| BW III G | 4 mg/L Fe ³⁺ + 10 mg/L O ₃ + UF 1 st permeate | | 30.2 ± 1.3 |
| | 4 mg/L Fe ³⁺ + 10 mg/L O ₃ + UF 3 rd permeate | | 27.8 ± 4.9 |
| | 4 mg/L Fe ³⁺ + 10 mg/L O ₃ + UF 5 th permeate | | 21.4 ± 2.9 |
| | | | |

6.3.5 Turbidity < 1 µm

Table 31: Turbidity < 1 µm of Ruhleben secondary treated effluent with different combinations of Fe³⁺- concentrations (0 - 6 mg Fe/L) and ozone dosages (0-10 mg O₃/L) – results of UF trials

| Name of experiment | Sample | Trial A | | Trial B | | Trial C | |
|--------------------|---|----------------------|------------------|----------------------|------------------|----------------------|------------------|
| | | Measured value [NTU] | Mean value [NTU] | Measured value [NTU] | Mean value [NTU] | Measured value [NTU] | Mean value [NTU] |
| UF I A-C | Effluent unfiltered | 2.60 | 2.49 ± 0.14 | 3.56 | 3.59 ± 0.02 | | |
| | | 2.55 | | 3.60 | | | |
| | | 2.33 | | 3.60 | | | |
| | 2 mg/L Fe ³⁺ unfiltered | 3.25 | 3.25 ± 0.23 | 5.43 | 5.42 ± 0.02 | | |
| | | 3.02 | | 5.44 | | | |
| | | 3.48 | | 5.40 | | | |
| | 6 mg/L Fe ³⁺ unfiltered | 5.44 | 5.24 ± 0.18 | 6.66 | 6.66 ± 0.15 | | |
| | | 5.20 | | 6.81 | | | |
| | | 5.09 | | 6.52 | | | |
| | Effluent + 10 mg/L O ₃ unfiltered | 1.84 | 1.74 ± 0.09 | 3.50 | 3.50 ± 0.05 | | |
| | | 1.72 | | 3.45 | | | |
| | | 1.66 | | 3.55 | | | |
| | 2 mg/L Fe ³⁺ + 10 mg/L O ₃ unfiltered | 3.05 | 3.14 ± 0.08 | 4.25 | 4.17 ± 0.08 | | |
| | | 3.16 | | 4.17 | | | |
| | | 3.20 | | 4.09 | | | |
| | 6 mg/L Fe ³⁺ 10 mg/L O ₃ unfiltered | 5.08 | 5.09 ± 0.14 | 6.38 | 6.34 ± 0.09 | | |
| | | 4.96 | | 6.40 | | | |
| | | 5.23 | | 6.23 | | | |
| | Effluent 1 µm filtered | 0.90 | 1.01 ± 0.00 | 1.29 | 1.27 ± 0.02 | 1.19 | 1.16 ± 0.03 |
| | | 1.12 | | 1.25 | | 1.16 | |
| | | 1.01 | | 1.27 | | 1.13 | |
| | 2 mg/L Fe ³⁺ 1 µm filtered | 0.80 | 0.81 ± 0.00 | 0.85 | 0.85 ± 0.01 | 0.94 | 0.90 ± 0.06 |
| | | 0.78 | | 0.83 | | 0.84 | |
| | | 0.85 | | 0.85 | | 0.94 | |
| | 6 mg/L Fe ³⁺ 1 µm filtered | 1.30 | 1.35 ± 0.00 | 0.99 | 1.01 ± 0.02 | 1.33 | 1.33 ± 0.01 |
| | | 1.43 | | 1.03 | | 1.32 | |
| | | 1.32 | | 1.02 | | 1.33 | |

| | | | | | | | |
|-------------------------|--------------------------|-------------|-------------|-------------|-------------|-------------|-------------|
| | Effluent + | 0.53 | | 1.33 | | 0.75 | |
| | 10 mg/L O ₃ | 0.58 | 0.59 ± 0.00 | 1.28 | 1.29 ± 0.03 | 0.67 | 0.71 ± 0.04 |
| | 1 µm filtered | 0.67 | | 1.27 | | 0.73 | |
| | 2 mg/L Fe ³⁺ | 0.41 | | 0.60 | | 0.53 | |
| | + 10 mg/L O ₃ | 0.48 | 0.46 ± 0.00 | 0.56 | 0.56 ± 0.05 | 0.57 | 0.56 ± 0.03 |
| | 1 µm filtered | 0.49 | | 0.51 | | 0.58 | |
| | 6 mg/L Fe ³⁺ | 0.47 | | 0.93 | | 0.91 | |
| | 10 mg/L O ₃ | 0.45 | 0.50 ± 0.00 | 0.94 | 0.94 ± 0.02 | 0.71 | 0.84 ± 0.11 |
| | 1 µm filtered | 0.58 | | 0.96 | | 0.92 | |
| | Effluent + UF | 0.14 | | 0.09 | | 0.10 | |
| | | 0.11 | 0.13 ± 0.02 | 0.09 | 0.09 ± 0.00 | 0.10 | 0.10 ± 0.00 |
| | | | | 0.09 | | 0.10 | |
| | Effluent + | 0.14 | | 0.09 | | 0.07 | |
| | 10 mg/L O ₃ + | 0.14 | 0.14 ± 0.00 | 0.09 | 0.09 ± 0.00 | 0.08 | 0.07 ± 0.00 |
| | UF | | | 0.09 | | 0.07 | |
| | 2 mg/L Fe ³⁺ | 0.09 | | 0.10 | | 0.11 | |
| | +UF | 0.18 | 0.12 ± 0.05 | 0.10 | 0.10 ± 0.00 | 0.12 | 0.12 ± 0.01 |
| | | 0.10 | | 0.11 | | 0.13 | |
| | 2 mg/L Fe ³⁺ | 0.09 | | 0.10 | | 0.10 | |
| | + 10 mg/L O ₃ | 0.11 | 0.10 ± 0.01 | 0.09 | 0.10 ± 0.01 | 0.08 | 0.08 ± 0.02 |
| | + UF | 0.09 | | 0.09 | | 0.07 | |
| | 6 mg/L Fe ³⁺ | 0.09 | | 0.10 | | 0.09 | |
| | +UF | 0.10 | 0.13 ± 0.05 | 0.11 | 0.11 ± 0.01 | 0.09 | 0.09 ± 0.01 |
| | | 0.19 | | 0.11 | | 0.08 | |
| | 6 mg/L Fe ³⁺ | 0.11 | | 0.10 | | 0.10 | |
| | 10 mg/L O ₃ + | 0.10 | 0.11 ± 0.01 | 0.11 | 0.10 ± 0.01 | 0.09 | 0.10 ± 0.01 |
| | UF | 0.12 | | 0.09 | | 0.10 | |
| UF II A-C | Effluent | 2.51 | | | | | |
| | unfiltered | 2.53 | 2.51 ± 0.03 | | | | |
| | | 2.48 | | | | | |
| | 2 mg/L Fe ³⁺ | 4.62 | | | | | |
| | unfiltered | 4.70 | 4.68 ± 0.06 | | | | |
| | | 4.73 | | | | | |
| | 6 mg/L Fe ³⁺ | 6.58 | | | | | |
| | unfiltered | 6.53 | 6.53 ± 0.05 | | | | |
| | | 6.48 | | | | | |
| | Effluent + | 2.63 | | | | | |
| | 2mg/L O ₃ | 2.67 | 2.00 ± 1.13 | | | | |
| | unfiltered | 0.69 | | | | | |
| | 2 mg/L Fe ³⁺ | 4.18 | | | | | |
| | + 2mg/L O ₃ | 4.09 | 4.13 ± 0.05 | | | | |
| | unfiltered | 4.11 | | | | | |
| | 6 mg/L Fe ³⁺ | 6.43 | | | | | |
| | 2mg/L O ₃ | 6.36 | 6.37 ± 0.05 | | | | |
| | unfiltered | 6.33 | | | | | |
| | Effluent | 0.87 | | 1.20 | | 0.93 | |
| | 1 µm filtered | 0.87 | 0.85 ± 0.04 | 1.19 | 1.21 ± 0.02 | 0.95 | 0.93 ± 0.01 |
| | 0.81 | | 1.23 | | 0.92 | | |
| 2 mg/L Fe ³⁺ | 0.60 | | 1.28 | | 1.00 | | |
| 1 µm filtered | 0.60 | 0.60 ± 0.00 | 1.32 | 1.31 ± 0.02 | 1.03 | 1.02 ± 0.02 | |
| | 0.60 | | 1.32 | | 1.02 | | |
| 6 mg/L Fe ³⁺ | 1.54 | | 1.54 | | 0.75 | | |
| 1 µm filtered | 1.59 | 1.57 ± 0.03 | 1.58 | 1.57 ± 0.03 | 0.77 | 0.74 ± 0.03 | |
| | 1.58 | | 1.60 | | 0.71 | | |
| Effluent + | 0.70 | | 1.04 | | 1.01 | | |
| 2mg/L O ₃ | 0.70 | 0.70 ± 0.00 | 1.03 | 1.03 ± 0.01 | 1.03 | 1.02 ± 0.01 | |
| 1 µm filtered | 0.70 | | 1.02 | | 1.03 | | |
| 2 mg/L Fe ³⁺ | 1.07 | | 1.33 | | 0.62 | | |
| + 2mg/L O ₃ | 1.02 | 1.01 ± 0.07 | 1.26 | 1.28 ± 0.04 | 0.67 | 0.61 ± 0.06 | |
| 1 µm filtered | 0.94 | | 1.26 | | 0.56 | | |
| 6 mg/L Fe ³⁺ | 1.49 | | 1.23 | | 0.87 | | |
| 2mg/L O ₃ | 1.51 | 1.51 ± 0.02 | 1.33 | 1.28 ± 0.05 | 0.86 | 0.86 ± 0.00 | |
| 1 µm filtered | 1.53 | | 1.29 | | 0.86 | | |
| Effluent + UF | 0.14 | | 0.38 | | 0.10 | | |
| | 0.13 | 0.14 ± 0.01 | 0.28 | 0.34 ± 0.07 | 0.10 | 0.11 ± 0.00 | |
| | 0.14 | | 0.36 | | 0.12 | | |

| | | | | | | | |
|-------|--------------------------|------|-------------|------|-------------|------|-------------|
| | 2 mg/L Fe ³⁺ | 0.09 | | 0.10 | | 0.11 | |
| | +UF | 0.10 | 0.10 ± 0.00 | 0.11 | 0.10 ± 0.01 | 0.14 | 0.13 ± 0.00 |
| | | 0.10 | | 0.09 | | 0.14 | |
| | 6 mg/L Fe ³⁺ | 0.13 | | 0.08 | | 0.08 | |
| | +UF | 0.12 | 0.13 ± 0.00 | 0.08 | 0.08 ± 0.01 | 0.09 | 0.09 ± 0.00 |
| | | 0.13 | | 0.09 | | 0.09 | |
| | Effluent + | 0.10 | | 0.11 | | 0.14 | |
| | 2mg/L O ₃ + | 0.10 | 0.10 ± 0.00 | 0.09 | 0.10 ± 0.01 | 0.13 | 0.13 ± 0.00 |
| | UF | 0.10 | | 0.09 | | 0.13 | |
| | 2 mg/L Fe ³⁺ | 0.14 | | 0.12 | | 0.09 | |
| | + 2mg/L O ₃ + | 0.13 | 0.14 ± 0.01 | 0.12 | 0.11 ± 0.02 | 0.10 | 0.10 ± 0.01 |
| | UF | 0.15 | | 0.08 | | 0.11 | |
| | 6 mg/L Fe ³⁺ | 0.13 | | 0.10 | | 0.11 | |
| | 2mg/L O ₃ + | 0.14 | 0.13 ± 0.01 | 0.09 | 0.10 ± 0.01 | 0.15 | 0.13 ± 0.02 |
| | UF | 0.12 | | 0.11 | | 0.13 | |
| | Effluent | 1.03 | | 1.24 | | | |
| | 1 µm filtered | 1.04 | 1.04 ± 0.01 | 1.23 | 1.24 ± 0.01 | | |
| | | 1.04 | | 1.25 | | | |
| | 2 mg/L Fe ³⁺ | 0.87 | | 0.94 | | | |
| | 1 µm filtered | 0.85 | 0.86 ± 0.01 | 0.94 | 0.95 ± 0.01 | | |
| | | 0.86 | | 0.96 | | | |
| | 2 mg/L Fe ³⁺ | 0.92 | | 0.97 | | | |
| | + 2mg/L O ₃ | 0.84 | 0.87 ± 0.04 | 0.96 | 0.96 ± 0.01 | | |
| | 1 µm filtered | 0.86 | | 0.95 | | | |
| | 2 mg/L Fe ³⁺ | 0.78 | | 0.88 | | | |
| | + 4 mg/L O ₃ | 0.78 | 0.77 ± 0.01 | 0.88 | 0.87 ± 0.02 | | |
| | 1 µm filtered | 0.76 | | 0.85 | | | |
| | 2 mg/L Fe ³⁺ | 0.69 | | 0.73 | | | |
| | + 6 mg/L O ₃ | 0.67 | 0.68 ± 0.01 | 0.72 | 0.72 ± 0.01 | | |
| | 1 µm filtered | 0.67 | | 0.72 | | | |
| | 2 mg/L Fe ³⁺ | 0.72 | | 0.62 | | | |
| | + 8 mg/L O ₃ | 0.71 | 0.71 ± 0.01 | 0.61 | 0.61 ± 0.02 | | |
| | 1 µm filtered | 0.70 | | 0.59 | | | |
| | 2 mg/L Fe ³⁺ | 0.73 | | 0.98 | | | |
| | + 10 mg/L O ₃ | 0.77 | 0.72 ± 0.05 | 0.94 | 0.96 ± 0.02 | | |
| | 1 µm filtered | 0.67 | | 0.96 | | | |
| | Effluent + UF | 0.11 | | 0.09 | | | |
| | | 0.11 | 0.11 ± 0.00 | 0.09 | 0.09 ± 0.00 | | |
| | | 0.12 | | 0.08 | | | |
| | 2 mg/L Fe ³⁺ | 0.12 | | | | | |
| | +UF | 0.10 | 0.11 ± 0.01 | | | | |
| | | 0.12 | | | | | |
| | 2 mg/L Fe ³⁺ | 0.09 | | | | | |
| | + 2 mg/L O ₃ | 0.10 | 0.10 ± 0.01 | | | | |
| | + UF | 0.10 | | | | | |
| | 2 mg/L Fe ³⁺ | 0.11 | | | | | |
| | + 4 mg/L O ₃ | 0.12 | 0.12 ± 0.01 | | | | |
| | + UF | 0.12 | | | | | |
| | 2 mg/L Fe ³⁺ | 0.11 | | | | | |
| | + 6 mg/L O ₃ | 0.12 | 0.11 ± 0.01 | | | | |
| | + UF | 0.09 | | | | | |
| | 2 mg/L Fe ³⁺ | 0.11 | | | | | |
| | + 8 mg/L O ₃ | 0.11 | 0.10 ± 0.01 | | | | |
| | + UF | 0.10 | | | | | |
| | 2 mg/L Fe ³⁺ | 0.09 | | | | | |
| | + 10 mg/L O ₃ | 0.09 | 0.09 ± 0.00 | | | | |
| | + UF | 0.09 | | | | | |
| | Effluent | 1.01 | | 0.95 | | | |
| UF IV | 1 µm filtered | 1.01 | 1.01 ± 0.00 | 0.98 | 0.97 ± 0.02 | | |
| A-B | | 1.01 | | 0.98 | | | |
| | 6 mg/L Fe ³⁺ | 1.55 | | 1.11 | | | |
| | 1 µm filtered | 1.55 | 1.55 ± 0.01 | 1.15 | 1.15 ± 0.05 | | |
| | | 1.56 | | 1.20 | | | |
| | 6 mg/L Fe ³⁺ | 0.71 | | 1.17 | | | |
| | + 2 mg/L O ₃ | 0.75 | 0.73 ± 0.02 | 1.11 | 1.13 ± 0.03 | | |
| | 1 µm filtered | 0.74 | | 1.12 | | | |

| | | | | | | | |
|------|--------------------------|------|-------------|------|-------------|------|-------------|
| | 6 mg/L Fe ³⁺ | 0.69 | | 1.09 | | | |
| | + 6 mg/L O ₃ | 0.68 | 0.68 ± 0.01 | 1.18 | 1.16 ± 0.06 | | |
| | 1 µm filtered | 0.68 | | 1.20 | | | |
| | 6 mg/L Fe ³⁺ | 0.56 | | 1.06 | | | |
| | + 10 mg/L O ₃ | 0.61 | 0.58 ± 0.03 | 1.09 | 1.08 ± 0.02 | | |
| | 1 µm filtered | 0.57 | | 1.08 | | | |
| | Effluent + UF | 0.09 | | 0.11 | | | |
| | | 0.12 | 0.44 ± 0.02 | 0.07 | 0.08 ± 0.02 | | |
| | | 1.10 | | 0.07 | | | |
| | Effluent | 1.01 | | 0.81 | | 5.29 | |
| | 1 µm filtered | 1.04 | 1.02 ± 0.02 | 0.80 | 0.80 ± 0.00 | 5.31 | 5.43 ± 0.22 |
| | | 1.02 | | 0.79 | | 5.68 | |
| | 4 mg/L Fe ³⁺ | 0.90 | | 0.80 | | | |
| | 1 µm filtered | 0.94 | 0.92 ± 0.02 | 0.85 | 0.83 ± 0.00 | | |
| | | 0.92 | | 0.84 | | | |
| | 4 mg/L Fe ³⁺ | 1.48 | | 1.25 | | | |
| | + 2 mg/L O ₃ | 1.45 | 1.44 ± 0.05 | 1.32 | 1.30 ± 0.00 | | |
| | 1 µm filtered | 1.38 | | 1.33 | | | |
| UF V | 4 mg/L Fe ³⁺ | 0.78 | | 0.60 | | | |
| A-C | + 6 mg/L O ₃ | 0.77 | 0.78 ± 0.02 | 0.60 | 0.60 ± 0.00 | | |
| | 1 µm filtered | 0.80 | | 0.60 | | | |
| | 4 mg/L Fe ³⁺ | 1.62 | | 0.45 | | | |
| | + 10 mg/L O ₃ | 1.62 | 1.62 ± 0.01 | 0.44 | 0.45 ± 0.00 | | |
| | 1 µm filtered | 1.61 | | 0.45 | | | |
| | Effluent + UF | 0.08 | | 0.09 | | | |
| | | 0.07 | 0.07 ± 0.00 | 0.09 | 0.10 ± 0.00 | | |
| | | 0.07 | | 0.10 | | | |

6.3.6 Temperature, pH and electric conductivity

Table 32: Temperature, pH and electric conductivity of Ruhleben secondary treated effluent with different combinations of Fe³⁺-concentrations (0 - 6 mg Fe/L) and ozone dosages (0-10 mg O₃/L) – results of UF trials

| Name of experiment | Sample | pH before UF | pH after UF | Temperature [°C] | Conductivity before UF [µS/cm] | Conductivity after UF [µS/cm] |
|--------------------|--|--------------|-------------|------------------|--------------------------------|-------------------------------|
| UF I-A | Effluent | 7.2 | 7.6 | 22.2 | 875 | 871 |
| | 2 mg/L Fe ³⁺ | 7.5 | 7.6 | 24.2 | 878 | 867 |
| | 6 mg/L Fe ³⁺ | 7.1 | 7.3 | 24.2 | 879 | 876 |
| | Effluent + 10 mg/L O ₃ | 8.1 | 8.2 | 24.2 | 873 | 861 |
| | 2 mg/L Fe ³⁺ + 10 mg/L O ₃ | 7.8 | 7.8 | 24.7 | 873 | 866 |
| | 6 mg/L Fe ³⁺ 10 mg/L O ₃ | 7.4 | 7.6 | 24.9 | 883 | 873 |
| UF I-B | Effluent | 7.2 | 7.6 | 22.2 | 906 | 902 |
| | 2 mg/L Fe ³⁺ | 7.3 | 7.5 | 22.9 | 906 | 898 |
| | 6 mg/L Fe ³⁺ | 7.1 | 7.5 | 23.1 | 914 | 904 |
| | Effluent + 10 mg/L O ₃ | 8.0 | 8.2 | 22.4 | 901 | 898 |
| | 2 mg/L Fe ³⁺ + 10 mg/L O ₃ | 7.8 | 8.1 | 22.5 | 906 | 887 |
| | 6 mg/L Fe ³⁺ 10 mg/L O ₃ | 7.4 | 7.6 | 23.5 | 912 | 906 |
| UF I-C | Effluent | 7.4 | 7.6 | 24.6 | 1206 | 1193 |
| | 2 mg/L Fe ³⁺ | 7.3 | 7.6 | 25.1 | 1207 | 1191 |
| | 6 mg/L Fe ³⁺ | 7.2 | 7.5 | 25.2 | 1208 | 1195 |
| | Effluent + 10 mg/L O ₃ | 8.0 | 8.2 | 25.5 | 1193 | 1181 |
| | 2 mg/L Fe ³⁺ + 10 mg/L O ₃ | 7.9 | 8.1 | 25.6 | 1200 | 1186 |
| | 6 mg/L Fe ³⁺ 10 mg/L O ₃ | 7.6 | 7.8 | 25.9 | 1206 | 1192 |
| UF II-A | Effluent | 7.3 | 7.8 | 23.0 | 1171 | 1159 |
| | 2 mg/L Fe ³⁺ | 8.6 | 7.7 | 23.0 | 1151 | 1153 |
| | 6 mg/L Fe ³⁺ | 7.2 | 7.6 | 24.0 | 1172 | 1163 |
| | Effluent + 2 mg/L O ₃ | 8.0 | 8.1 | 23.8 | 1165 | 1153 |
| | 2 mg/L Fe ³⁺ + 2 mg/L O ₃ | 7.8 | 7.9 | 24.1 | 1171 | 1152 |
| | 6 mg/L Fe ³⁺ 2 mg/L O ₃ | 7.4 | 7.7 | 24.2 | 1176 | 1159 |
| UF II-B | Effluent | 7.6 | 7.8 | 24.9 | 1252 | 1256 |
| | 2 mg/L Fe ³⁺ | 7.4 | 7.7 | 24.9 | 1251 | 1233 |
| | 6 mg/L Fe ³⁺ | 7.2 | 7.6 | 24.9 | 1255 | 1249 |

| | | | | | | |
|----------|--|-----|-----|------|------|------|
| | Effluent + 2 mg/L O ₃ | 7.9 | 8.1 | 25.0 | 1246 | 1221 |
| | 2 mg/L Fe ³⁺ + 2 mg/L O ₃ | 7.8 | 7.9 | 25.0 | 1250 | 1241 |
| | 6 mg/L Fe ³⁺ + 2 mg/L O ₃ | 7.6 | 7.9 | 24.9 | 1256 | 1249 |
| UF II-C | Effluent | 7.3 | 7.6 | 23.8 | 1010 | 998 |
| | 2 mg/L Fe ³⁺ | 7.3 | 7.5 | 24.9 | 1009 | 999 |
| | 6 mg/L Fe ³⁺ | 7.1 | 7.3 | 24.3 | 1012 | 1000 |
| | Effluent + 2 mg/L O ₃ | 7.9 | 8.0 | 25.2 | 1001 | 990 |
| | 2 mg/L Fe ³⁺ + 2 mg/L O ₃ | 7.8 | 7.9 | 25.0 | 1010 | 988 |
| | 6 mg/L Fe ³⁺ + 2 mg/L O ₃ | 7.3 | 7.4 | 25.0 | 1011 | 1000 |
| UF III-A | Effluent | 7.3 | 7.7 | 23.9 | 1007 | 991 |
| | 2 mg/L Fe ³⁺ | 7.3 | 7.6 | 23.8 | 1008 | 994 |
| | 2 mg/L Fe ³⁺ + 2 mg/L O ₃ | 7.6 | 7.8 | 24.1 | 1006 | 994 |
| | 2 mg/L Fe ³⁺ + 4 mg/L O ₃ | 7.7 | 7.9 | 24.3 | 1004 | 992 |
| | 2 mg/L Fe ³⁺ + 6 mg/L O ₃ | 7.8 | 7.9 | 24.5 | 1004 | 995 |
| | 2 mg/L Fe ³⁺ + 8 mg/L O ₃ | 7.8 | 8.0 | 24.6 | 1001 | 993 |
| | 2 mg/L Fe ³⁺ + 10 mg/L O ₃ | 7.9 | 7.9 | 24.7 | 1004 | 994 |
| | Effluent | 7.4 | 7.7 | 23.9 | 1172 | 1164 |
| UF III-B | 2 mg/L Fe ³⁺ | 7.4 | 7.8 | 24.9 | 1174 | 1148 |
| | 2 mg/L Fe ³⁺ + 2 mg/L O ₃ | 7.7 | 7.9 | 24.4 | 1170 | 1162 |
| | 2 mg/L Fe ³⁺ + 4 mg/L O ₃ | 7.9 | 8.0 | 24.5 | 1168 | 1152 |
| | 2 mg/L Fe ³⁺ + 6 mg/L O ₃ | 7.9 | 8.0 | 24.8 | 1166 | 1151 |
| | 2 mg/L Fe ³⁺ + 8 mg/L O ₃ | 7.9 | 8.0 | 24.9 | 1169 | 1156 |
| | 2 mg/L Fe ³⁺ + 10 mg/L O ₃ | 7.9 | 8.0 | 24.8 | 1166 | 1151 |
| | Effluent | 7.2 | 7.7 | 24.3 | 1285 | 1271 |
| UF IV-A | 6 mg/L Fe ³⁺ | 7.2 | 7.4 | 24.5 | 1287 | 1275 |
| | 6 mg/L Fe ³⁺ + 2 mg/L O ₃ | 7.4 | 7.6 | 24.8 | 1280 | 1270 |
| | 6 mg/L Fe ³⁺ + 6 mg/L O ₃ | 7.5 | 7.7 | 24.9 | 1277 | 1262 |
| | 6 mg/L Fe ³⁺ + 10 mg/L O ₃ | 7.6 | 7.7 | 25.3 | 1274 | 1267 |
| | Effluent | 7.3 | 7.6 | 21.6 | 1180 | 1163 |
| UF IV-B | 6 mg/L Fe ³⁺ | 7.0 | 7.4 | 22.1 | 1182 | 1163 |
| | 6 mg/L Fe ³⁺ + 2 mg/L O ₃ | 7.4 | 7.6 | 22.9 | 1183 | 1166 |
| | 6 mg/L Fe ³⁺ + 6 mg/L O ₃ | 7.5 | 7.7 | 22.9 | 1181 | 1164 |
| | 6 mg/L Fe ³⁺ + 10 mg/L O ₃ | 7.5 | 7.6 | 23.0 | 1181 | 1167 |
| | Effluent | 7.3 | 7.6 | 21.8 | 1108 | 1099 |
| UF V-A | 4 mg/L Fe ³⁺ | 7.2 | 7.5 | 22.0 | 1112 | 1097 |
| | 4 mg/L Fe ³⁺ + 2 mg/L O ₃ | 7.5 | 7.8 | 22.4 | 1106 | 1094 |
| | 4 mg/L Fe ³⁺ + 6 mg/L O ₃ | 7.6 | 7.8 | 22.8 | 1106 | 1095 |
| | 4 mg/L Fe ³⁺ + 10 mg/L O ₃ | 7.6 | 7.8 | 22.9 | 1105 | 1097 |
| UF V-B | Effluent | 7.5 | 7.7 | 21.8 | 1307 | 1283 |
| | 4 mg/L Fe ³⁺ | 7.3 | 7.7 | 22.7 | 1305 | 1291 |
| | 4 mg/L Fe ³⁺ + 2 mg/L O ₃ | 7.6 | 7.8 | 22.9 | 1306 | 1289 |
| | 4 mg/L Fe ³⁺ + 6 mg/L O ₃ | 7.7 | 7.9 | 23.3 | 1304 | 1291 |
| | 4 mg/L Fe ³⁺ + 10 mg/L O ₃ | 7.7 | 7.9 | 23.3 | 1302 | 1280 |
| UF V-C | Effluent | 7.2 | 7.6 | 19.8 | 1165 | 1156 |
| | 4 mg/L Fe ³⁺ | 7.1 | 7.3 | 21.2 | 1168 | 1156 |
| | 4 mg/L Fe ³⁺ + 2 mg/L O ₃ | 7.4 | 7.6 | 21.1 | 1165 | 1150 |
| | 4 mg/L Fe ³⁺ + 6 mg/L O ₃ | 7.5 | 7.7 | 21.5 | 1161 | 1152 |
| | 4 mg/L Fe ³⁺ + 10 mg/L O ₃ | 7.6 | 7.8 | 21.9 | 1162 | 1149 |

Table 33: Temperature, pH and electric conductivity of untreated Ruhleben secondary effluent and Ruhleben secondary effluent with 4 mg Fe³⁺/L and different ozone dosages (0-10 mg O₃/L) – results of BW trials

| Name of experiment | Sample | pH | Temperature [°C] | Conductivity [µS/cm] |
|--------------------|---|-----|------------------|----------------------|
| BW I A/B | Effluent | 7.6 | 21.9 | 1272 |
| | Effluent + UF 1 st permeate | 7.7 | 22.5 | 1260 |
| | Effluent + UF 3 rd permeate | 7.8 | 22.8 | 1267 |

| | | | | |
|---------------|--|-----|------|------|
| | Effluent + UF 5 th permeate | 7.8 | 23 | 1267 |
| | 4 mg/L Fe ³⁺ + 6 mg/L O ₃ | 7.7 | 22.5 | 1271 |
| | 4 mg/L Fe ³⁺ + 6 mg/L O ₃ + UF 1 st permeate | 8.0 | 22.6 | 1256 |
| | 4 mg/L Fe ³⁺ + 6 mg/L O ₃ + UF 3 rd permeate | 8.1 | 22.9 | 1260 |
| | 4 mg/L Fe ³⁺ + 6 mg/L O ₃ + UF 5 th permeate | 8.2 | 22.9 | 1260 |
| | Effluent | 7.2 | 20.9 | 1197 |
| | Effluent + UF 1 st permeate | 7.6 | 20.5 | 1184 |
| | Effluent + UF 3 rd permeate | 7.7 | 21.2 | 1196 |
| | Effluent + UF 5 th permeate | 8.2 | 22.3 | 1191 |
| BW I C/D | 4 mg/L Fe ³⁺ + 6 mg/L O ₃ | 7.7 | 20.8 | 1198 |
| | 4 mg/L Fe ³⁺ + 6 mg/L O ₃ + UF 1 st permeate | 7.9 | 20.6 | 1178 |
| | 4 mg/L Fe ³⁺ + 6 mg/L O ₃ + UF 3 rd permeate | 7.9 | 21.2 | 1192 |
| | 4 mg/L Fe ³⁺ + 6 mg/L O ₃ + UF 5 th permeate | 8.2 | 22.3 | 1191 |
| | 4 mg/L Fe ³⁺ + 6 mg/L O ₃ + UF 5 th permeate | 7.6 | 21.9 | 1272 |
| | Effluent | 7.1 | 19.2 | 953 |
| | 4 mg/L Fe ³⁺ | 7.3 | 19.3 | 957 |
| | 4 mg/L Fe ³⁺ + UF 1 st permeate | 7.7 | 18.8 | 940 |
| | 4 mg/L Fe ³⁺ + UF 3 rd permeate | 8.0 | 19.4 | 945 |
| | 4 mg/L Fe ³⁺ + UF 5 th permeate | 7.9 | 19.7 | 952 |
| BW II A/C | 4 mg/L Fe ³⁺ + 6 mg/L O ₃ | 7.7 | 19.3 | 953 |
| | 4 mg/L Fe ³⁺ + 6 mg/L O ₃ + UF 1 st permeate | 7.5 | 18.8 | 940 |
| | 4 mg/L Fe ³⁺ + 6 mg/L O ₃ + UF 3 rd permeate | 7.8 | 19.2 | 947 |
| | 4 mg/L Fe ³⁺ + 6 mg/L O ₃ + UF 5 th permeate | 7.9 | 20 | 945 |
| | Effluent | 7.2 | 20.2 | 1358 |
| | 4 mg/L Fe ³⁺ | 7.2 | 20.4 | 1362 |
| | 4 mg/L Fe ³⁺ + UF 1 st permeate | 7.5 | 20.6 | 1348 |
| | 4 mg/L Fe ³⁺ + UF 3 rd permeate | 7.6 | 20.9 | 1355 |
| | 4 mg/L Fe ³⁺ + UF 5 th permeate | 7.9 | 21.6 | 1356 |
| BW II B/D | 4 mg/L Fe ³⁺ + 6 mg/L O ₃ | 7.6 | 20.5 | 1356 |
| | 4 mg/L Fe ³⁺ + 6 mg/L O ₃ + UF 1 st permeate | 7.7 | 20.5 | 1337 |
| | 4 mg/L Fe ³⁺ + 6 mg/L O ₃ + UF 3 rd permeate | 7.8 | 20.6 | 1349 |
| | 4 mg/L Fe ³⁺ + 6 mg/L O ₃ + UF 5 th permeate | 8.2 | 21.5 | 1345 |
| BW III A-C | Effluent | 7.3 | 21.2 | 1258 |

| | | | | |
|---------------|---|-----|------|------|
| | 4 mg/L Fe ³⁺ | 7.2 | 21.4 | 1261 |
| | 4 mg/L Fe ³⁺ + UF 1 st permeate | 7.5 | 21.5 | 1251 |
| | 4 mg/L Fe ³⁺ + UF 3 rd permeate | 7.9 | 21.7 | 1253 |
| | 4 mg/L Fe ³⁺ + UF 5 th permeate | 7.8 | 21.8 | 1255 |
| | 4 mg/L Fe ³⁺ + 2 mg/L O ₃ | 7.5 | 21.4 | 1257 |
| | 4 mg/L Fe ³⁺ + 2 mg/L O ₃ + UF 1 st permeate | 7.7 | 21.6 | 1246 |
| | 4 mg/L Fe ³⁺ + 2 mg/L O ₃ + UF 3 rd permeate | 7.9 | 21.8 | 1247 |
| | 4 mg/L Fe ³⁺ + 2 mg/L O ₃ + UF 5 th permeate | 8.0 | 22.3 | 1247 |
| | 4 mg/L Fe ³⁺ + 6 mg/L O ₃ | 7.6 | 21.3 | 1259 |
| | 4 mg/L Fe ³⁺ + 6 mg/L O ₃ + UF 1 st permeate | 7.7 | 21.8 | 1248 |
| | 4 mg/L Fe ³⁺ + 6 mg/L O ₃ + UF 3 rd permeate | 8.1 | 18.4 | 1245 |
| | 4 mg/L Fe ³⁺ + 6 mg/L O ₃ + UF 5 th permeate | 8.1 | 21.9 | 1255 |
| | 4 mg/L Fe ³⁺ + 10 mg/L O ₃ | 7.2 | 20.4 | 1195 |
| | 4 mg/L Fe ³⁺ + 10 mg/L O ₃ + UF 1 st permeate | 7.2 | 20.7 | 1198 |
| | 4 mg/L Fe ³⁺ + 10 mg/L O ₃ + UF 3 rd permeate | 7.4 | 21 | 1182 |
| | 4 mg/L Fe ³⁺ + 10 mg/L O ₃ + UF 5 th permeate | 7.6 | 21.4 | 1189 |
| BW III D-G | Effluent | 8.0 | 21.9 | 1189 |
| | 4 mg/L Fe ³⁺ | 7.5 | 20.8 | 1197 |
| | 4 mg/L Fe ³⁺ + UF 1 st permeate | 7.6 | 21.1 | 1183 |
| | 4 mg/L Fe ³⁺ + UF 3 rd permeate | 7.8 | 21.5 | 1187 |
| | 4 mg/L Fe ³⁺ + UF 5 th permeate | 8.1 | 22.6 | 1187 |
| | 4 mg/L Fe ³⁺ + 2 mg/L O ₃ | 7.6 | 22.1 | 1197 |
| | 4 mg/L Fe ³⁺ + 2 mg/L O ₃ + UF 1 st permeate | 7.8 | 22 | 1184 |
| | 4 mg/L Fe ³⁺ + 2 mg/L O ₃ + UF 3 rd permeate | 7.9 | 22.2 | 1189 |
| | 4 mg/L Fe ³⁺ + 2 mg/L O ₃ + UF 5 th permeate | 8.1 | 22.3 | 1189 |
| | 4 mg/L Fe ³⁺ + 6 mg/L O ₃ | 7.3 | 21.2 | 1258 |
| | 4 mg/L Fe ³⁺ + 6 mg/L O ₃ + UF 1 st permeate | 7.2 | 21.4 | 1261 |
| | 4 mg/L Fe ³⁺ + 6 mg/L O ₃ + UF 3 rd permeate | 7.5 | 21.5 | 1251 |
| | 4 mg/L Fe ³⁺ + 6 mg/L O ₃ + UF 5 th permeate | 7.9 | 21.7 | 1253 |
| | 4 mg/L Fe ³⁺ + 10 mg/L O ₃ | 7.8 | 21.8 | 1255 |
| | 4 mg/L Fe ³⁺ + 10 mg/L O ₃ + UF 1 st permeate | 7.5 | 21.4 | 1257 |
| | 4 mg/L Fe ³⁺ + 10 mg/L O ₃ + UF 3 rd permeate | 7.7 | 21.6 | 1246 |
| | 4 mg/L Fe ³⁺ + 10 mg/L O ₃ + UF 5 th permeate | 7.9 | 21.8 | 1247 |

| | | | |
|---|-----|------|------|
| 4 mg/L Fe ³⁺ + 10 mg/L O ₃ | 7.8 | 21.8 | 1255 |
| 4 mg/L Fe ³⁺ + 10 mg/L O ₃ + UF 1 st permeate | 7.5 | 21.4 | 1257 |
| 4 mg/L Fe ³⁺ + 10 mg/L O ₃ + UF 3 rd permeate | 7.7 | 21.6 | 1246 |
| 4 mg/L Fe ³⁺ + 10 mg/L O ₃ + UF 5 th permeate | 7.9 | 21.8 | 1247 |

Table 34: Temperature, pH and electric conductivity results of MF trials

| Name of experiment | Sample | pH | Temperature [°C] | Conductivity [μS/cm] |
|--------------------|----------|-----|------------------|----------------------|
| MF I A-C | Effluent | 7.2 | 20.1 | 1275 |

6.3.7 UVA 254

Table 35: UVA 254 of Ruhleben secondary treated effluent with different combinations of Fe³⁺-concentrations (0 - 6 mg Fe/L) and ozone dosages (0-10 mg O₃/L) – results of UF trials

| Name of experiment | Sample | Trial A | Trial B | Trial C | Mean value [1/m] | c/c ₀ |
|---|--|-----------------------|-----------------------|-----------------------|------------------|------------------|
| | | Measured value [1/cm] | Measured value [1/cm] | Measured value [1/cm] | | |
| UF I A-C | Effluent | | 0.2675 | 0.2889 | 27.84 ± 1.25 | 1.00 ± 0.05 |
| | | | 0.2666 | 0.2888 | | |
| | | | 0.2668 | 0.2916 | | |
| | Effluent + UF | | 0.2614 | 0.2807 | 27.12 ± 1.07 | 0.97 ± 0.08 |
| | | | 0.2612 | 0.2806 | | |
| | | | 0.2618 | 0.2815 | | |
| | Effluent + 10 mg/L O ₃ | | 0.1448 | 0.1653 | 15.54 ± 1.10 | 0.56 ± 0.12 |
| | | | 0.1464 | 0.1646 | | |
| | | | 0.1451 | 0.1663 | | |
| | Effluent + 10 mg/L O ₃ + UF | | 0.1443 | 0.1599 | 15.28 ± 0.89 | 0.55 ± 0.10 |
| | | | 0.1464 | 0.1600 | | |
| | | | 0.1437 | 0.1626 | | |
| | 2 mg/L Fe ³⁺ | | 0.2475 | 0.2731 | 26.05 ± 1.38 | 0.94 ± 0.10 |
| | | | 0.2480 | 0.2733 | | |
| | | | 0.2481 | 0.2728 | | |
| | 2 mg/L Fe ³⁺ +UF | | 0.2444 | 0.2668 | 25.56 ± 1.23 | 0.92 ± 0.09 |
| | | | 0.2443 | 0.2670 | | |
| | | | 0.2442 | 0.2667 | | |
| | 2 mg/L Fe ³⁺ + 10 mg/L O ₃ | | 0.1326 | 0.1531 | 14.15 ± 1.02 | 0.51 ± 0.12 |
| | | | 0.1323 | 0.1504 | | |
| | | 0.1320 | 0.1485 | | | |
| 2 mg/L Fe ³⁺ + 10 mg/L O ₃ + UF | | 0.1309 | 0.1469 | 13.92 ± 0.88 | 0.50 ± 0.11 | |
| | | 0.1312 | 0.1468 | | | |
| | | 0.1316 | 0.1480 | | | |
| 6 mg/L Fe ³⁺ | | 0.2197 | 0.2521 | 23.58 ± 1.75 | 0.85 ± 0.12 | |
| | | 0.2197 | 0.2507 | | | |
| | | 0.2200 | 0.2523 | | | |
| 6 mg/L Fe ³⁺ +UF | | 0.2167 | 0.2540 | 23.60 ± 2.14 | 0.85 ± 0.14 | |
| | | 0.2165 | 0.2542 | | | |
| | | 0.2165 | 0.2583 | | | |
| 6 mg/L Fe ³⁺ 10 mg/L O ₃ | | 0.1169 | 0.1365 | 12.66 ± 1.08 | 0.45 ± 0.13 | |
| | | 0.1165 | 0.1367 | | | |
| | | 0.1169 | 0.1360 | | | |
| 6 mg/L Fe ³⁺ 10 mg/L O ₃ + UF | | 0.1147 | 0.1346 | 12.48 ± 1.07 | 0.45 ± 0.13 | |
| | | 0.1153 | 0.1347 | | | |
| | | 0.1150 | 0.1345 | | | |
| UF II A-C | Effluent | 0.3162 | 0.2710 | 0.2836 | 29.05 ± 2.09 | 1.00 ± 0.08 |
| | | 0.3146 | 0.2706 | 0.2831 | | |
| | | 0.3210 | 0.2708 | 0.2838 | | |

| | | | | | | |
|--|--|---------|--------|--------------|--------------|-------------|
| | | 0.3105 | 0.2631 | 0.2768 | | |
| | Effluent + UF | 0.3120 | 0.2641 | 0.2765 | 28.83 ± 2.11 | 0.98 ± 0.15 |
| | | 0.3103 | 0.2644 | 0.2769 | | |
| | | 0.2855 | 0.2363 | 0.2472 | | |
| | Effluent + 2mg/L O ₃ | 0.2856 | 0.2339 | 0.2475 | 25.60 ± 2.28 | 0.88 ± 0.16 |
| | | 0.2857 | 0.2349 | 0.2478 | | |
| | | 0.2780 | 0.2293 | 0.2411 | | |
| | Effluent + 2mg/L O ₃ + UF | 0.2788 | 0.2298 | 0.2408 | 24.96 ± 2.19 | 0.86 ± 0.16 |
| | | 0.2773 | 0.2301 | 0.2411 | | |
| | | 0.3056 | 0.2541 | 0.2739 | | |
| | 2 mg/L Fe ³⁺ | 0.3058 | 0.2545 | 0.2737 | 27.79 ± 2.25 | 0.96 ± 0.15 |
| | | 0.3058 | 0.2538 | 0.2740 | | |
| | | 0.2995 | 0.2491 | 0.2606 | | |
| | 2 mg/L Fe ³⁺ +UF | 0.2997 | 0.2497 | 0.2611 | 27.00 ± 2.27 | 0.93 ± 0.16 |
| | | 0.2993 | 0.2499 | 0.2612 | | |
| | | 0.2731 | 0.2099 | 0.2356 | | |
| | 2 mg/L Fe ³⁺ + 2mg/L O ₃ | 0.2729 | 0.2099 | 0.2357 | 23.96 ± 2.77 | 0.82 ± 0.19 |
| | | 0.2740 | 0.2096 | 0.2358 | | |
| | | 0.2714 | 0.2048 | 0.2302 | | |
| | 2 mg/L Fe ³⁺ + 2mg/L O ₃ + UF | 0.2727 | 0.2068 | 0.2297 | 23.61 ± 2.85 | 0.81 ± 0.19 |
| | | 0.2704 | 0.2081 | 0.2310 | | |
| | | 0.2828 | 0.2270 | 0.2441 | | |
| | 6 mg/L Fe ³⁺ | 0.2813 | 0.2269 | 0.2439 | 25.08 ± 2.42 | 0.86 ± 0.17 |
| | | 0.2806 | 0.2270 | 0.2440 | | |
| | | 0.2785 | 0.2225 | 0.2393 | | |
| | 6 mg/L Fe ³⁺ +UF | 0.2827 | 0.2223 | 0.2400 | 24.51 ± 2.32 | 0.84 ± 0.17 |
| | | 0.2577 | 0.2232 | 0.2395 | | |
| | | 0.2555 | 0.2087 | 0.2186 | | |
| | 6 mg/L Fe ³⁺ 2mg/L O ₃ | 0.2556 | 0.2070 | 0.2187 | 22.73 ± 2.17 | 0.78 ± 0.17 |
| | | 0.2554 | 0.2076 | 0.2183 | | |
| | | 0.2521 | 0.2043 | 0.2117 | | |
| | 6 mg/L Fe ³⁺ 2mg/L O ₃ + UF | 0.2524 | 0.2050 | 0.2119 | 22.31 ± 2.24 | 0.77 ± 0.17 |
| | | 0.2543 | 0.2047 | 0.2123 | | |
| UF III A-B | | 0.2720 | 0.2810 | | | |
| | Effluent | 0.2701 | 0.2799 | | 27.51 ± 0.56 | 1.00 ± 0.02 |
| | | 0.26970 | 0.2794 | | | |
| | | 0.2633 | 0.2757 | | | |
| | Effluent + UF | 0.2639 | 0.2760 | | 26.99 ± 0.68 | 0.98 ± 0.05 |
| | | 0.2640 | 0.2766 | | | |
| | | 0.2603 | 0.2692 | | | |
| | 2 mg/L Fe ³⁺ | 0.2525 | 0.2677 | | 26.23 ± 0.70 | 0.95 ± 0.05 |
| | | 0.2562 | 0.2676 | | | |
| | | 0.2487 | 0.2612 | | | |
| | 2 mg/L Fe ³⁺ +UF | 0.2498 | 0.2617 | | 25.53 ± 0.69 | 0.93 ± 0.05 |
| | | 0.2484 | 0.2617 | | | |
| | | 0.2235 | 0.2339 | | | |
| | 2 mg/L Fe ³⁺ + 2mg/L O ₃ | 0.2257 | 0.2334 | | 22.93 ± 0.50 | 0.83 ± 0.04 |
| | | 0.2250 | 0.2342 | | | |
| | | 0.2178 | 0.2313 | | | |
| | 2 mg/L Fe ³⁺ + 2 mg/L O ₃ + UF | 0.2172 | 0.2311 | | 22.43 ± 0.74 | 0.82 ± 0.05 |
| | | 0.2177 | 0.2309 | | | |
| | | 0.2047 | 0.2132 | | | |
| | 2 mg/L Fe ³⁺ + 4 mg/L O ₃ | 0.2031 | 0.2136 | | 20.84 ± 0.54 | 0.76 ± 0.05 |
| | 0.2027 | 0.2133 | | | | |
| | 0.2008 | 0.2109 | | | | |
| 2 mg/L Fe ³⁺ + 4 mg/L O ₃ + UF | 0.2059 | 0.2113 | | 20.65 ± 0.53 | 0.75 ± 0.05 | |
| | 0.1993 | 0.2105 | | | | |
| | 0.1853 | 0.1910 | | | | |
| 2 mg/L Fe ³⁺ + 6 mg/L O ₃ | 0.1792 | 0.1901 | | 18.56 ± 0.51 | 0.67 ± 0.05 | |
| | 0.1807 | 0.1889 | | | | |
| | 0.1771 | 0.1883 | | | | |
| 2 mg/L Fe ³⁺ + 6 mg/L O ₃ + UF | 0.1771 | 0.1876 | | 18.26 ± 0.58 | 0.66 ± 0.05 | |
| | 0.1776 | 0.1877 | | | | |
| | 0.1531 | 0.1605 | | | | |
| 2 mg/L Fe ³⁺ + 8 mg/L O ₃ | 0.1518 | 0.1607 | | 15.69 ± 0.41 | 0.57 ± 0.05 | |
| | 0.1549 | 0.1603 | | | | |

| | | | | | | | |
|--|---|---|----------------------------|----------------------------|----------------------------|--------------|-------------|
| | 2 mg/L Fe ³⁺ + 8 mg/L O ₃ + UF | 0.1502 0.1494 0.1507 | 0.1604 0.1627 0.1623 | | 15.60 ± 0.65 | 0.57 ± 0.06 | |
| | 2 mg/L Fe ³⁺ + 10 mg/L O ₃ | 0.1291 0.1288 0.1286 | 0.1338 0.1342 0.1347 | | 13.15 ± 0.30 | 0.48 ± 0.04 | |
| | 2 mg/L Fe ³⁺ + 10 mg/L O ₃ + UF | 0.1275 0.1271 0.1278 | 0.1371 0.1360 0.1359 | | 13.19 ± 0.49 | 0.48 ± 0.06 | |
| UF IV A-B | Effluent | 0.2706 0.2704 0.2701 | 0.2851 0.2844 0.2847 | | 27.76 ± 0.79 | - | |
| | Effluent + UF | 0.2695 0.2686 0.2690 | 0.2748 0.2754 0.2753 | | 27.21 ± 0.34 | 0.98 ± 0.04 | |
| | 6 mg/L Fe ³⁺ | 0.2436 0.2428 0.2438 | 0.2484 0.2477 0.2476 | | 24.57 ± 0.25 | 0.89 ± 0.04 | |
| | 6 mg/L Fe ³⁺ +UF | 0.2407 0.2428 0.2423 | 0.2421 0.2410 0.2414 | | 24.17 ± 0.08 | 0.87 ± 0.03 | |
| | 6 mg/L Fe ³⁺ + 2 mg/L O ₃ | 0.2141 0.2144 0.2146 | 0.2211 0.2213 0.2210 | | 21.78 ± 0.37 | 0.78 ± 0.05 | |
| | 6 mg/L Fe ³⁺ + 2 mg/L O ₃ + UF | 0.2129 0.2105 0.2121 | 0.2150 0.2166 0.2154 | | 21.38 ± 0.23 | 0.77 ± 0.04 | |
| | 6 mg/L Fe ³⁺ + 6 mg/L O ₃ | 0.1808 0.1817 0.1801 | 0.1655 0.1643 0.1644 | | 17.28 ± 0.89 | 0.62 ± 0.08 | |
| | 6 mg/L Fe ³⁺ + 6 mg/L O ₃ + UF | 0.1785 0.1791 0.1784 | 0.1617 0.1619 0.1608 | | 17.01 ± 0.94 | 0.61 ± 0.08 | |
| | 6 mg/L Fe ³⁺ + 10 mg/L O ₃ | 0.1297 0.1304 0.1311 | 0.1265 0.1266 0.1282 | | 12.88 ± 0.20 | 0.46 ± 0.04 | |
| | 6 mg/L Fe ³⁺ + 10 mg/L O ₃ + UF | 0.1330 0.1342 0.1318 | 0.1319 0.1318 0.1321 | | 13.25 ± 0.10 | 0.48 ± 0.04 | |
| | UF V A-C | Effluent | 0.2863 0.2873 0.2879 | 0.2881 0.2880 0.2882 | 0.2678 0.2668 0.2670 | 28.08 ± 1.02 | |
| | | Effluent + UF | 0.2800 0.2790 0.2879 | 0.2797 0.2793 0.2794 | 0.2598 0.2601 0.2593 | 27.30 ± 1.00 | 0.97 ± 0.07 |
| | | 4 mg/L Fe ³⁺ | 0.2599 0.2593 0.2597 | 0.2634 0.2633 0.2634 | 0.2361 0.2362 0.2358 | 25.30 ± 1.28 | 0.90 ± 0.09 |
| | | 4 mg/L Fe ³⁺ +UF | 0.2552 0.2544 0.2551 | 0.2599 0.2588 0.2588 | 0.2318 0.2314 0.2311 | 24.85 ± 1.29 | 0.88 ± 0.09 |
| | | 4 mg/L Fe ³⁺ + 2 mg/L O ₃ | 0.2287 0.2291 0.2299 | 0.2304 0.2306 0.2302 | 0.2134 0.2139 0.2130 | 22.44 ± 0.82 | 0.80 ± 0.07 |
| 4 mg/L Fe ³⁺ + 2 mg/L O ₃ + UF | | 0.2265 0.2263 0.2259 | 0.2257 0.2258 0.2258 | 0.2095 0.2095 0.2086 | 22.04 ± 0.84 | 0.78 ± 0.07 | |
| 4 mg/L Fe ³⁺ + 6 mg/L O ₃ | | 0.1674 0.1676 0.1670 | 0.1697 0.1692 0.1702 | 0.1757 0.1759 0.1753 | 17.09 ± 0.37 | 0.61 ± 0.06 | |
| 4 mg/L Fe ³⁺ + 6 mg/L O ₃ + UF | | 0.1640 0.1632 0.1631 | 0.1668 0.1668 0.1672 | 0.1725 0.1723 0.1726 | 16.76 ± 0.40 | 0.60 ± 0.06 | |
| 4 mg/L Fe ³⁺ + 10 mg/L O ₃ | | 0.1301 0.1320 0.1297 | 0.1323 0.1317 0.1321 | 0.1337 0.1337 0.1325 | 13.18 ± 0.15 | 0.47 ± 0.05 | |

| | | | | | |
|--|--------|--------|--------|--------------|-------------|
| 4 mg/L Fe ³⁺ + 10 mg/L O ₃ + UF | 0.1283 | 0.1291 | 0.1317 | 12.94 ± 0.16 | 0.46 ± 0.05 |
| | 0.1285 | 0.1282 | 0.1313 | | |
| | 0.1276 | 0.1285 | 0.1311 | | |

Table 36: UVA 254 of untreated Ruhleben secondary effluent and Ruhleben secondary effluent with 4 mg Fe³⁺/L and different ozone dosages (0-10 mg O₃/L) – results of BW trials

| Name of experiment | Sample | Trial 1 Measured value [1/cm] | Trial 2 Measured value [1/cm] | Trial 3 Measured value [1/cm] | Mean value [1/m] | c/c ₀ |
|--|---|-------------------------------------|-------------------------------------|-------------------------------------|---------------------|------------------|
| BW I A/C | Effluent | 0.3081 | 0.2839 | | 29.60 ± 1.30 | 1.00 ± 0.0440 |
| | | 0.3089 | 0.2840 | | | |
| | | 0.3066 | 0.2845 | | | |
| | Effluent + UF 1 st permeate | 0.2988 | 0.2643 | | 28.16 ± 1.92 | 0.95 ± 0.1121 |
| | | 0.2993 | 0.2640 | | | |
| | | 0.2991 | 0.2639 | | | |
| | Effluent + UF 3 rd permeate | 0.3026 | 0.2662 | | 28.41 ± 1.89 | 0.96 ± 0.1104 |
| | | 0.3001 | 0.2668 | | | |
| | | 0.3011 | 0.2676 | | | |
| | Effluent + UF 5 th permeate | 0.3020 | 0.2659 | | 28.42 ± 1.94 | 0.96 ± 0.1124 |
| | | 0.3018 | 0.2666 | | | |
| | | 0.3020 | 0.2668 | | | |
| BW I B/D | 4 mg/L Fe ³⁺ + 6 mg/L O ₃ | 0.1787 | 0.1596 | | 16.88 ± 0.99 | 0.57 ± 0.1026 |
| | | 0.1776 | 0.1601 | | | |
| | | 0.1772 | 0.1597 | | | |
| | 4 mg/L Fe ³⁺ + 6 mg/L O ₃ + UF 1 st permeate | 0.1756 | 0.1563 | | 16.58 ± 1.03 | 0.56 ± 0.1062 |
| | | 0.1749 | 0.1566 | | | |
| | | 0.1752 | 0.1563 | | | |
| | 4 mg/L Fe ³⁺ + 6 mg/L O ₃ + UF 3 rd permeate | 0.1762 | 0.1598 | | 16.75 ± 0.89 | 0.57 ± 0.0970 |
| | | 0.1750 | 0.1595 | | | |
| | | 0.1754 | 0.1588 | | | |
| | 4 mg/L Fe ³⁺ + 6 mg/L O ₃ + UF 5 th permeate | 0.1807 | 0.1619 | | 17.10 ± 0.97 | 0.58 ± 0.1006 |
| | | 0.1795 | 0.1627 | | | |
| | | 0.1793 | 0.1620 | | | |
| BW II A/C | Effluent | | 0.2162 | 0.2636 | 23.96 ± 2.61 | 1.00 ± 0.11 |
| | | | 0.2156 | 0.2624 | | |
| | | | 0.2155 | 0.2643 | | |
| | 4 mg/L Fe ³⁺ | | 0.1855 | 0.2357 | 22.35 ± 2.53 | 0.93 ± 0.22 |
| | | | | 0.2366 | | |
| | | | | 0.2360 | | |
| | 4 mg/L Fe ³⁺ + UF 1 st permeate | | 0.1809 | 0.2312 | 20.58 ± 2.71 | 0.86 ± 0.24 |
| | | | 0.1818 | 0.2304 | | |
| | | | 0.1805 | 0.2302 | | |
| | 4 mg/L Fe ³⁺ + UF 3 rd permeate | | 0.1881 | 0.2361 | 21.14 ± 2.65 | 0.88 ± 0.23 |
| | | | 0.1868 | 0.2356 | | |
| | | | 0.1866 | 0.2351 | | |
| 4 mg/L Fe ³⁺ + UF 5 th permeate | | 0.1903 | 0.2409 | 21.69 ± 2.95 | 0.91 ± 0.25 | |
| | | 0.1907 | 0.2504 | | | |
| | | 0.1895 | 0.2395 | | | |
| BW II B/D | 4 mg/L Fe ³⁺ + 6 mg/L O ₃ | | 0.1252 | 0.1660 | 14.57 ± 2.24 | 0.61 ± 0.26 |
| | | | 0.1253 | 0.1662 | | |
| | | | 0.1253 | 0.1664 | | |
| | 4 mg/L Fe ³⁺ + 6 mg/L O ₃ + UF 1 st permeate | | 0.1218 | 0.1630 | 14.24 ± 2.26 | 0.59 ± 0.27 |
| | | | 0.1216 | 0.1622 | | |
| | | | 0.1217 | 0.1638 | | |
| | 4 mg/L Fe ³⁺ + 6 mg/L O ₃ + UF 3 rd permeate | | 0.1257 | 0.1640 | 14.61 ± 2.09 | 0.61 ± 0.25 |
| | | | 0.1282 | 0.1656 | | |
| | | | 0.1274 | 0.1658 | | |
| | 4 mg/L Fe ³⁺ + 6 mg/L O ₃ + UF 5 th permeate | | 0.1285 | 0.1691 | 14.87 ± 2.28 | 0.62 ± 0.26 |
| | | | 0.1278 | 0.1695 | | |
| | | | 0.1273 | 0.1700 | | |
| BW III | Effluent | 0.2784 | 0.2717 | | 27.50 ± 0.36 | 1.00 ± 0.0130 |
| | | 0.2779 | 0.2716 | | | |
| | | 0.2783 | 0.2718 | | | |

| | | | | | |
|---------------|--|--------|--------|--------------|---------------|
| BW III A/D | 4 mg/L Fe ³⁺ | 0.2460 | 0.2417 | 24.41 ± 0.20 | 0.89 ± 0.0213 |
| | | 0.2461 | 0.2421 | | |
| | | 0.2457 | 0.2431 | | |
| | 4 mg/L Fe ³⁺ + UF 1 st permeate | 0.2430 | 0.2349 | 23.89 ± 0.42 | 0.87 ± 0.0307 |
| | | 0.2428 | 0.2352 | | |
| | | 0.2425 | 0.2350 | | |
| | 4 mg/L Fe ³⁺ + UF 3 rd permeate | 0.2474 | 0.2432 | 24.47 ± 0.32 | 0.89 ± 0.0261 |
| | | 0.2474 | 0.2407 | | |
| | | 0.2477 | 0.2416 | | |
| | 4 mg/L Fe ³⁺ + UF 5 th permeate | 0.2495 | 0.2444 | 24.77 ± 0.33 | 0.90 ± 0.0263 |
| | | 0.2513 | 0.2450 | | |
| | | 0.2510 | 0.2447 | | |
| BW III B/E | 4 mg/L Fe ³⁺ + 2 mg/L O ₃ | 0.2188 | 0.2142 | 21.60 ± 0.28 | 0.79 ± 0.0257 |
| | | 0.2182 | 0.2133 | | |
| | | 0.2185 | 0.2131 | | |
| | 4 mg/L Fe ³⁺ + 2 mg/L O ₃ + UF 1 st permeate | 0.2108 | 0.2084 | 21.03 ± 0.16 | 0.76 ± 0.0206 |
| | | 0.2107 | 0.2097 | | |
| | | 0.2129 | 0.2090 | | |
| | 4 mg/L Fe ³⁺ + 2 mg/L O ₃ + UF 3 rd permeate | 0.2152 | 0.2123 | 21.32 ± 0.15 | 0.78 ± 0.0200 |
| | | 0.2144 | 0.2120 | | |
| | | 0.2138 | 0.2114 | | |
| | 4 mg/L Fe ³⁺ + 2 mg/L O ₃ + UF 5 th permeate | 0.2156 | 0.2142 | 21.48 ± 0.07 | 0.78 ± 0.0164 |
| | | 0.2154 | 0.2141 | | |
| | | 0.2154 | 0.2141 | | |
| BW III C/F | 4 mg/L Fe ³⁺ + 6 mg/L O ₃ | 0.1631 | 0.1638 | 16.36 ± 0.05 | 0.59 ± 0.0160 |
| | | 0.1644 | 0.1637 | | |
| | | 0.1634 | 0.1631 | | |
| | 4 mg/L Fe ³⁺ + 6 mg/L O ₃ + UF 1 st permeate | 0.1603 | 0.1583 | 16.00 ± 0.12 | 0.58 ± 0.0206 |
| | | 0.1618 | 0.1599 | | |
| | | 0.1605 | 0.1590 | | |
| | 4 mg/L Fe ³⁺ + 6 mg/L O ₃ + UF 3 rd permeate | 0.1626 | 0.1622 | 16.20 ± 0.09 | 0.59 ± 0.0186 |
| | | 0.1627 | 0.1603 | | |
| | | 0.1626 | 0.1617 | | |
| | 4 mg/L Fe ³⁺ + 6 mg/L O ₃ + UF 5 th permeate | 0.1643 | 0.1643 | 16.38 ± 0.06 | 0.60 ± 0.0166 |
| | | 0.1638 | 0.1628 | | |
| | | 0.1642 | 0.1634 | | |
| BW III G | 4 mg/L Fe ³⁺ + 10 mg/L O ₃ | 0.1236 | 0.1236 | 12.38 ± 0.02 | 0.45 ± 0.0146 |
| | | 0.1237 | 0.1237 | | |
| | | 0.1240 | 0.1240 | | |
| | 4 mg/L Fe ³⁺ + 10 mg/L O ₃ + UF 1 st permeate | 0.1194 | 0.1194 | 11.98 ± 0.05 | 0.44 ± 0.0168 |
| | | 0.1203 | 0.1203 | | |
| | | 0.1197 | 0.1197 | | |
| | 4 mg/L Fe ³⁺ + 10 mg/L O ₃ + UF 3 rd permeate | 0.1223 | 0.1223 | 12.28 ± 0.07 | 0.45 ± 0.0185 |
| | | 0.1226 | 0.1226 | | |
| | | 0.1236 | 0.1236 | | |
| | 4 mg/L Fe ³⁺ + 10 mg/L O ₃ + UF 5 th permeate | 0.1259 | 0.1259 | 12.54 ± 0.09 | 0.46 ± 0.0201 |
| | | 0.1260 | 0.1260 | | |
| | | 0.1244 | 0.1244 | | |

6.3.8 Colour 436

Table 37: Colour 436 of Ruhleben secondary treated effluent with different combinations of Fe³⁺-concentrations (0 - 6 mg Fe/L) and ozone dosages (0-10 mg O₃/L) – results of UF trials

| Name of experiment | Sample | Trial A | Trial B | Trial C | Mean value [1/m] | c/c ₀ | |
|--------------------|---------------|-----------------------|-----------------------|-----------------------|------------------|------------------|-------------|
| | | Measured value [1/cm] | Measured value [1/cm] | Measured value [1/cm] | | | |
| UF I A-C | Effluent | | 0.0144 | 0.0179 | 1.62 ± 0.21 | 1.00 ± 0.13 | |
| | | | | 0.0142 | | | 0.0179 |
| | | | | 0.0142 | | | 0.0184 |
| | Effluent + UF | | | 0.0143 | 0.0173 | 1.59 ± 0.16 | 0.98 ± 0.23 |
| | | | | 0.0142 | 0.0172 | | |
| | | | | 0.0147 | 0.0174 | | |

| | | | | | |
|---|---|--------|--------|-------------|-------------|
| | | 0.0022 | 0.0046 | | |
| | Effluent + 10 mg/L O ₃ | 0.0029 | 0.0043 | 0.35 ± 0.11 | 0.21 ± 0.45 |
| | | 0.0023 | 0.0045 | | |
| | Effluent + 10 mg/L O ₃ + UF | 0.0023 | 0.0035 | | |
| | | 0.0029 | 0.0036 | 0.32 ± 0.09 | 0.20 ± 0.41 |
| | | 0.0022 | 0.0046 | | |
| | 2 mg/L Fe ³⁺ | 0.0127 | 0.0165 | | |
| | | 0.0128 | 0.0165 | 1.47 ± 0.20 | 0.91 ± 0.27 |
| | | 0.0130 | 0.0165 | | |
| | 2 mg/L Fe ³⁺ +UF | 0.0132 | 0.0160 | | |
| | | 0.0132 | 0.0168 | 1.47 ± 0.18 | 0.91 ± 0.25 |
| | | 0.0128 | 0.0159 | | |
| | 2 mg/L Fe ³⁺ + 10 mg/L O ₃ | 0.0020 | 0.0029 | | |
| | | 0.0017 | 0.0029 | 0.24 ± 0.06 | 0.15 ± 0.39 |
| | | 0.0017 | 0.0029 | | |
| | 2 mg/L Fe ³⁺ + 10 mg/L O ₃ + UF | 0.0019 | 0.0026 | | |
| | | 0.0018 | 0.0028 | 0.25 ± 0.06 | 0.15 ± 0.36 |
| | | 0.0025 | 0.0033 | | |
| | 6 mg/L Fe ³⁺ | 0.0108 | 0.0151 | | |
| | | 0.0109 | 0.0146 | 1.29 ± 0.23 | 0.80 ± 0.30 |
| | | 0.0109 | 0.0152 | | |
| | 6 mg/L Fe ³⁺ +UF | 0.0108 | 0.0148 | | |
| | | 0.0106 | 0.0149 | 1.29 ± 0.25 | 0.80 ± 0.32 |
| | | 0.0105 | 0.0157 | | |
| | 6 mg/L Fe ³⁺ 10 mg/L O ₃ | 0.0014 | 0.0021 | | |
| | | 0.0008 | 0.0022 | 0.16 ± 0.06 | 0.10 ± 0.51 |
| | | 0.0010 | 0.0021 | | |
| | 6 mg/L Fe ³⁺ 10 mg/L O ₃ + UF | 0.0010 | 0.0020 | | |
| | | 0.0010 | 0.0021 | 0.15 ± 0.06 | 0.09 ± 0.50 |
| | | 0.0010 | 0.0020 | | |
| UF II A-C | Effluent | 0.0170 | 0.0166 | 0.0170 | |
| | | 0.0165 | 0.0143 | 0.0164 | 1.67 ± 0.12 |
| | | 0.0169 | 0.0188 | 0.0164 | |
| | Effluent + UF | 0.0162 | 0.0188 | 0.0154 | |
| | | 0.0163 | 0.0196 | 0.0155 | 1.71 ± 0.19 |
| | | 0.0164 | 0.0204 | 0.0156 | |
| | Effluent + 2mg/L O ₃ | 0.0096 | 0.0118 | 0.0114 | |
| | | 0.0098 | 0.0118 | 0.0093 | 1.06 ± 0.12 |
| | | 0.0096 | 0.0123 | 0.0099 | |
| | Effluent + 2mg/L O ₃ + UF | 0.0094 | 0.0136 | 0.0094 | |
| | | 0.0092 | 0.0148 | 0.0093 | 1.07 ± 0.22 |
| | | 0.0094 | 0.0118 | 0.0095 | |
| | 2 mg/L Fe ³⁺ | 0.0163 | 0.0172 | 0.0146 | |
| | | 0.0162 | 0.0180 | 0.0146 | 1.62 ± 0.13 |
| | | 0.0163 | 0.0178 | 0.0146 | |
| | 2 mg/L Fe ³⁺ +UF | 0.0146 | 0.0171 | 0.0135 | |
| | | 0.0146 | 0.0174 | 0.0139 | 1.52 ± 0.15 |
| | | 0.0146 | 0.0167 | 0.0141 | |
| | 2 mg/L Fe ³⁺ + 2mg/L O ₃ | 0.0089 | 0.0113 | 0.0066 | |
| | | 0.0089 | 0.0109 | 0.0067 | 0.89 ± 0.20 |
| | 0.0088 | 0.0113 | 0.0067 | | |
| 2 mg/L Fe ³⁺ + 2mg/L O ₃ + UF | 0.0088 | 0.0118 | 0.0062 | | |
| | 0.0084 | 0.0127 | 0.0067 | 0.91 ± 0.23 | |
| | 0.0089 | 0.0111 | 0.0076 | | |
| 6 mg/L Fe ³⁺ | 0.0137 | 0.0183 | 0.0126 | | |
| | 0.0134 | 0.0177 | 0.0125 | 1.45 ± 0.23 | |
| | 0.0135 | 0.0161 | 0.0123 | | |
| 6 mg/L Fe ³⁺ +UF | 0.0132 | 0.0149 | 0.0117 | | |
| | 0.0132 | 0.0151 | 0.0114 | 1.30 ± 0.14 | |
| | 0.0132 | 0.0121 | 0.0118 | | |
| 6 mg/L Fe ³⁺ 2mg/L O ₃ | 0.0081 | 0.0100 | 0.0092 | | |
| | 0.0084 | 0.0100 | 0.0078 | 0.88 ± 0.10 | |
| | 0.0080 | 0.0102 | 0.0079 | | |
| 6 mg/L Fe ³⁺ 2mg/L O ₃ + UF | 0.0073 | 0.0092 | 0.0074 | | |
| | 0.0074 | 0.0093 | 0.0077 | 0.82 ± 0.10 | |
| | 0.0076 | 0.0100 | 0.0075 | | |

| | | | | | |
|--|---|--------|-------------|-------------|-------------|
| UF III A-B | Effluent | 0.0174 | 0.0181 | 1.70 ± 0.07 | 1.00 ± 0.04 |
| | | 0.0162 | 0.0169 | | |
| | | 0.0165 | 0.0166 | | |
| | Effluent + UF | 0.0177 | 0.0163 | 1.69 ± 0.08 | 1.00 ± 0.09 |
| | | 0.0177 | 0.0161 | | |
| | | 0.0174 | 0.0163 | | |
| | 2 mg/L Fe ³⁺ | 0.0179 | 0.0168 | 1.62 ± 0.13 | 0.96 ± 0.12 |
| | | 0.0147 | 0.0153 | | |
| | | 0.0172 | 0.0153 | | |
| | 2 mg/L Fe ³⁺ +UF | 0.0147 | 0.0148 | 1.49 ± 0.02 | 0.88 ± 0.06 |
| | | 0.0148 | 0.0151 | | |
| | | 0.0147 | 0.0152 | | |
| | 2 mg/L Fe ³⁺ + 2mg/L O ₃ | 0.0100 | 0.0100 | 1.00 ± 0.04 | 0.59 ± 0.08 |
| | | 0.0102 | 0.0093 | | |
| | | 0.0103 | 0.0101 | | |
| | 2 mg/L Fe ³⁺ + 2 mg/L O ₃ + UF | 0.0099 | 0.0091 | 0.92 ± 0.05 | 0.54 ± 0.09 |
| | | 0.0086 | 0.0089 | | |
| | | 0.0093 | 0.0095 | | |
| | 2 mg/L Fe ³⁺ + 4 mg/L O ₃ | 0.0073 | 0.0070 | 0.68 ± 0.03 | 0.40 ± 0.09 |
| | | 0.0066 | 0.0069 | | |
| 0.0064 | | 0.0065 | | | |
| 2 mg/L Fe ³⁺ + 4 mg/L O ₃ + UF | 0.0089 | 0.0070 | 0.82 ± 0.24 | 0.48 ± 0.34 | |
| | 0.0127 | 0.0075 | | | |
| | 0.0061 | 0.0067 | | | |
| 2 mg/L Fe ³⁺ + 6 mg/L O ₃ | 0.0070 | 0.0061 | 0.53 ± 0.11 | 0.31 ± 0.24 | |
| | 0.0041 | 0.0053 | | | |
| | 0.0048 | 0.0046 | | | |
| 2 mg/L Fe ³⁺ + 6 mg/L O ₃ + UF | 0.0045 | 0.0049 | 0.50 ± 0.05 | 0.29 ± 0.14 | |
| | 0.0048 | 0.0049 | | | |
| | 0.0060 | 0.0049 | | | |
| 2 mg/L Fe ³⁺ + 8 mg/L O ₃ | 0.0040 | 0.0037 | 0.41 ± 0.11 | 0.24 ± 0.30 | |
| | 0.0031 | 0.0041 | | | |
| | 0.0061 | 0.0034 | | | |
| 2 mg/L Fe ³⁺ + 8 mg/L O ₃ + UF | 0.0036 | 0.0034 | 0.36 ± 0.04 | 0.21 ± 0.15 | |
| | 0.0030 | 0.0040 | | | |
| | 0.0041 | 0.0037 | | | |
| 2 mg/L Fe ³⁺ + 10 mg/L O ₃ | 0.0029 | 0.0024 | 0.25 ± 0.04 | 0.15 ± 0.18 | |
| | 0.0019 | 0.0025 | | | |
| | 0.0024 | 0.0028 | | | |
| 2 mg/L Fe ³⁺ + 10 mg/L O ₃ + UF | 0.0017 | 0.0034 | 0.26 ± 0.06 | 0.15 ± 0.29 | |
| | 0.0020 | 0.0028 | | | |
| | 0.0030 | 0.0024 | | | |
| UF IV A-B | Effluent | 0.0166 | 0.0171 | 1.66 ± 0.03 | 1.00 ± 0.02 |
| | | 0.0166 | 0.0161 | | |
| | | 0.0165 | 0.0164 | | |
| | Effluent + UF | 0.0194 | 0.0157 | 1.71 ± 0.16 | 1.03 ± 0.12 |
| | | 0.0177 | 0.0158 | | |
| | | 0.0183 | 0.0155 | | |
| | 6 mg/L Fe ³⁺ | 0.0144 | 0.0132 | 1.39 ± 0.07 | 0.84 ± 0.07 |
| | | 0.0143 | 0.0133 | | |
| | | 0.0149 | 0.0134 | | |
| | 6 mg/L Fe ³⁺ +UF | 0.0143 | 0.0128 | 1.37 ± 0.12 | 0.83 ± 0.11 |
| | | 0.0151 | 0.0124 | | |
| | | 0.0149 | 0.0126 | | |
| | 6 mg/L Fe ³⁺ + 2 mg/L O ₃ | 0.0095 | 0.0080 | 0.89 ± 0.09 | 0.54 ± 0.12 |
| | | 0.0095 | 0.0082 | | |
| | | 0.0100 | 0.0080 | | |
| | 6 mg/L Fe ³⁺ + 2 mg/L O ₃ + UF | 0.0088 | 0.0076 | 0.85 ± 0.05 | 0.51 ± 0.08 |
| | | 0.0086 | 0.0091 | | |
| | | 0.0083 | 0.0084 | | |
| | 6 mg/L Fe ³⁺ + 6 mg/L O ₃ | 0.0049 | 0.0036 | 0.43 ± 0.08 | 0.26 ± 0.20 |
| | | 0.0053 | 0.0036 | | |
| 0.0048 | | 0.0037 | | | |
| 6 mg/L Fe ³⁺ 6 mg/L O ₃ + UF | 0.0044 | 0.0033 | 0.42 ± 0.09 | 0.25 ± 0.23 | |
| | 0.0055 | 0.0038 | | | |
| | 0.0048 | 0.0033 | | | |

| | | | | | | |
|--|--|--------|--------|-------------|-------------|-------------|
| UF V A-C | 6 mg/L Fe ³⁺ + 10 mg/L O ₃ | 0.0015 | 0.0021 | 0.22 ± 0.04 | 0.13 ± 0.22 | |
| | | 0.0021 | 0.0020 | | | |
| | | 0.0024 | 0.0028 | | | |
| | 6 mg/L Fe ³⁺ + 10 mg/L O ₃ + UF | 0.0031 | 0.0027 | 0.30 ± 0.05 | 0.18 ± 0.19 | |
| | | 0.0039 | 0.0026 | | | |
| | | 0.0030 | 0.0026 | | | |
| | Effluent | 0.0157 | 0.0165 | 0.0170 | 1.64 ± 0.04 | 1.00 ± 0.02 |
| | | 0.0160 | 0.0164 | 0.0166 | | |
| | | 0.0163 | 0.0164 | 0.0168 | | |
| | Effluent + UF | 0.0156 | 0.0163 | 0.0164 | 1.61 ± 0.04 | 0.98 ± 0.05 |
| | | 0.0154 | 0.0161 | 0.0167 | | |
| | | 0.0157 | 0.0162 | 0.0161 | | |
| | 4 mg/L Fe ³⁺ | 0.0139 | 0.0145 | 0.0139 | 1.41 ± 0.04 | 0.86 ± 0.05 |
| | | 0.0138 | 0.0145 | 0.0139 | | |
| | | 0.0142 | 0.0145 | 0.0135 | | |
| | 4 mg/L Fe ³⁺ +UF | 0.0136 | 0.0139 | 0.0137 | 1.36 ± 0.04 | 0.83 ± 0.05 |
| | | 0.0131 | 0.0139 | 0.0132 | | |
| | | 0.0133 | 0.0141 | 0.0132 | | |
| | 4 mg/L Fe ³⁺ + 2 mg/L O ₃ | 0.0076 | 0.0082 | 0.0090 | 0.84 ± 0.06 | 0.51 ± 0.09 |
| | | 0.0078 | 0.0088 | 0.0093 | | |
| 0.0082 | | 0.0082 | 0.0088 | | | |
| 4 mg/L Fe ³⁺ + 2 mg/L O ₃ + UF | 0.0078 | 0.0078 | 0.0088 | 0.81 ± 0.05 | 0.49 ± 0.09 | |
| | 0.0077 | 0.0079 | 0.0088 | | | |
| | 0.0078 | 0.0077 | 0.0088 | | | |
| 4 mg/L Fe ³⁺ + 6 mg/L O ₃ | 0.0032 | 0.0029 | 0.0044 | 0.36 ± 0.06 | 0.22 ± 0.19 | |
| | 0.0036 | 0.0030 | 0.0043 | | | |
| | 0.0032 | 0.0034 | 0.0042 | | | |
| 4 mg/L Fe ³⁺ + 6 mg/L O ₃ + UF | 0.0029 | 0.0029 | 0.0040 | 0.32 ± 0.06 | 0.20 ± 0.21 | |
| | 0.0027 | 0.0030 | 0.0038 | | | |
| | 0.0029 | 0.0027 | 0.0042 | | | |
| 4 mg/L Fe ³⁺ + 10 mg/L O ₃ | 0.0021 | 0.0014 | 0.0025 | 0.18 ± 0.04 | 0.11 ± 0.25 | |
| | 0.0016 | 0.0014 | 0.0022 | | | |
| | 0.0016 | 0.0014 | 0.0018 | | | |
| 4 mg/L Fe ³⁺ + 10 mg/L O ₃ + UF | 0.0016 | 0.0012 | 0.0021 | 0.16 ± 0.04 | 0.10 ± 0.29 | |
| | 0.0017 | 0.0010 | 0.0022 | | | |
| | 0.0014 | 0.0014 | 0.0021 | | | |

Table 38: Colour 436 of untreated Ruhleben secondary effluent and Ruhleben secondary effluent with 4 mg Fe³⁺/L and different ozone dosages (0-10 mg O₃/L) – results of BW trials

| Name of experiment | Sample | Trial 1 | Trial 2 | Trial 3 | Mean value [1/m] | c/c ₀ |
|--------------------|---|-----------------------|-----------------------|-----------------------|------------------|------------------|
| | | Measured value [1/cm] | Measured value [1/cm] | Measured value [1/cm] | | |
| BW I A/C | Effluent | 0.0192 | 0.0174 | | 1.85 ± 0.11 | 1.00 ± 0.06 |
| | | 0.0200 | 0.0176 | | | |
| | | 0.0189 | 0.0177 | | | |
| | Effluent + UF 1 st permeate | 0.0187 | 0.0159 | | 1.73 ± 0.16 | 0.94 ± 0.15 |
| | | 0.0190 | 0.0160 | | | |
| | | 0.0187 | 0.0156 | | | |
| | Effluent + UF 3 rd permeate | 0.0196 | 0.0163 | | 1.78 ± 0.15 | 0.96 ± 0.14 |
| | | 0.0186 | 0.0164 | | | |
| | | 0.0191 | 0.0165 | | | |
| | Effluent + UF 5 th permeate | 0.0193 | 0.0163 | | 1.79 ± 0.15 | 0.97 ± 0.14 |
| | | 0.0190 | 0.0166 | | | |
| | | 0.0194 | 0.0165 | | | |
| BW I B/D | 4 mg/L Fe ³⁺ + 6 mg/L O ₃ | 0.0057 | 0.0037 | | 0.45 ± 0.08 | 0.24 ± 0.24 |
| | | 0.0050 | 0.0040 | | | |
| | | 0.0050 | 0.0037 | | | |
| | 4 mg/L Fe ³⁺ + 6 mg/L O ₃ + UF 1 st permeate | 0.0043 | 0.0037 | | 0.40 ± 0.04 | 0.22 ± 0.15 |
| | | 0.0044 | 0.0038 | | | |
| | | 0.0044 | 0.0036 | | | |
| | 4 mg/L Fe ³⁺ + 6 mg/L O ₃ + UF 3 rd permeate | 0.0055 | 0.0040 | | 0.42 ± 0.06 | 0.23 ± 0.21 |
| | | 0.0040 | 0.0039 | | | |
| | | 0.0042 | 0.0037 | | | |

| | | | | | | |
|---------------|--|----------------------------|--------------------------------------|----------------------------|-------------|-------------|
| | 4 mg/L Fe ³⁺ + 6 mg/L O ₃ + UF | 0.0050 0.0045 | 0.0042 0.0042 | | 0.44 ± 0.03 | 0.24 ± 0.14 |
| | 5 th permeate | 0.0044 | 0.0040 | | | |
| BW II | Effluent | | 0.0132 0.0130 0.0129 | 0.0154 0.0152 0.0170 | 1.45 ± 0.17 | 1.00 ± 0.12 |
| | 4 mg/L Fe ³⁺ | | 0.0105 0.0131 0.0132 0.0140 | | 1.27 ± 0.15 | 0.88 ± 0.24 |
| BW II A/C | 4 mg/L Fe ³⁺ + UF 1 st permeate | | 0.0100 0.0108 0.0099 | 0.0131 0.0128 0.0136 | 1.17 ± 0.17 | 0.81 ± 0.26 |
| | 4 mg/L Fe ³⁺ + UF 3 rd permeate | | 0.0109 0.0104 0.0104 | 0.0137 0.0131 0.0129 | 1.19 ± 0.15 | 0.82 ± 0.24 |
| | 4 mg/L Fe ³⁺ + UF 5 th permeate | | 0.0108 0.0107 0.0109 | 0.0146 0.0140 | 1.22 ± 0.19 | 0.84 ± 0.27 |
| | 4 mg/L Fe ³⁺ + 6 mg/L O ₃ | | 0.0027 0.0027 0.0028 | 0.0040 0.0039 0.0047 | 0.35 ± 0.09 | 0.24 ± 0.36 |
| BW II B/D | 4 mg/L Fe ³⁺ + 6 mg/L O ₃ + UF 1 st permeate | | 0.0029 0.0024 0.0026 | 0.0040 0.0044 0.0041 | 0.34 ± 0.09 | 0.24 ± 0.37 |
| | 4 mg/L Fe ³⁺ + 6 mg/L O ₃ + UF 3 rd permeate | | 0.0033 0.0041 0.0041 | 0.0041 0.0040 0.0035 | 0.39 ± 0.04 | 0.27 ± 0.21 |
| | 4 mg/L Fe ³⁺ + 6 mg/L O ₃ + UF 5 th permeate | | 0.0042 0.0035 0.0030 | 0.0044 0.0044 0.0044 | 0.40 ± 0.06 | 0.28 ± 0.27 |
| BW III | Effluent | 0.0179 0.0175 0.0179 | 0.0175 0.0172 0.0180 | | 1.77 ± 0.03 | 1.00 ± 0.02 |
| | 4 mg/L Fe ³⁺ | 0.0145 0.0144 0.0141 | 0.0141 0.0143 0.0143 | | 1.43 ± 0.02 | 0.81 ± 0.03 |
| BW III A/D | 4 mg/L Fe ³⁺ + UF 1 st permeate | 0.0142 0.0149 0.0147 | 0.0135 0.0135 0.0145 | | 1.42 ± 0.06 | 0.80 ± 0.06 |
| | 4 mg/L Fe ³⁺ + UF 3 rd permeate | 0.0145 0.0145 0.0146 | 0.0148 0.0143 0.0152 | | 1.47 ± 0.03 | 0.83 ± 0.04 |
| | 4 mg/L Fe ³⁺ + UF 5 th permeate | 0.0149 0.0167 0.0153 | 0.0149 0.0157 0.0158 | | 1.56 ± 0.07 | 0.88 ± 0.06 |
| | 4 mg/L Fe ³⁺ + 2 mg/L O ₃ | 0.0092 0.0099 0.0091 | 0.0094 0.0090 0.0090 | | 0.93 ± 0.03 | 0.52 ± 0.06 |
| BW III B/E | 4 mg/L Fe ³⁺ + 2 mg/L O ₃ + UF 1 st permeate | 0.0083 0.0081 0.0096 | 0.0085 0.0089 0.0085 | | 0.87 ± 0.05 | 0.49 ± 0.08 |
| | 4 mg/L Fe ³⁺ + 2 mg/L O ₃ + UF 3 rd permeate | 0.0088 0.0086 0.0084 | 0.0088 0.0088 0.0086 | | 0.87 ± 0.02 | 0.49 ± 0.04 |
| | 4 mg/L Fe ³⁺ + 2 mg/L O ₃ + UF 5 th permeate | 0.0088 0.0087 0.0087 | 0.0089 0.0090 0.0090 | | 0.89 ± 0.01 | 0.50 ± 0.03 |
| BW III C/F | 4 mg/L Fe ³⁺ + 6 mg/L O ₃ | 0.0044 0.0046 0.0044 | 0.0048 0.0047 0.0047 | | 0.46 ± 0.02 | 0.26 ± 0.05 |
| | 4 mg/L Fe ³⁺ + 6 mg/L O ₃ + UF 1 st permeate | 0.0039 0.0048 0.0038 | 0.0041 0.0050 0.0049 | | 0.44 ± 0.05 | 0.25 ± 0.14 |
| | 4 mg/L Fe ³⁺ + 6 mg/L O ₃ + UF 3 rd permeate | 0.0047 0.0044 0.0046 | 0.0057 0.0042 0.0047 | | 0.47 ± 0.05 | 0.27 ± 0.13 |

| | | | | | |
|---|---|--------|-------------|-------------|-------------|
| BW III G | 4 mg/L Fe ³⁺ + 6 mg/L O ₃ + UF | 0.0043 | 0.0046 | 0.44 ± 0.02 | 0.25 ± 0.07 |
| | 5 th permeate | 0.0043 | 0.0043 | | |
| | | 0.0041 | 0.0047 | | |
| | 4 mg/L Fe ³⁺ + 10 mg/L O ₃ | | 0.0033 | 0.32 ± 0.01 | 0.18 ± 0.04 |
| | | | 0.0032 | | |
| | | | 0.0032 | | |
| | 4 mg/L Fe ³⁺ + 10 mg/L O ₃ + UF | | 0.0028 | 0.30 ± 0.03 | 0.17 ± 0.12 |
| | 1 st permeate | | 0.0033 | | |
| | | | 0.0028 | | |
| | 4 mg/L Fe ³⁺ + 10 mg/L O ₃ + UF | | 0.0033 | 0.33 ± 0.01 | 0.19 ± 0.04 |
| 3 rd permeate | | 0.0033 | | | |
| | | 0.0034 | | | |
| 4 mg/L Fe ³⁺ + 10 mg/L O ₃ + UF | | 0.0037 | 0.38 ± 0.03 | 0.22 ± 0.10 | |
| 5 th permeate | | 0.0042 | | | |
| | | 0.0036 | | | |

6.3.9 COD_f

Table 39: COD_f of Ruhleben secondary treated effluent with different combinations of Fe³⁺-concentrations (0 - 6 mg Fe/L) and ozone dosages (0-10 mg O₃/L) – results of UF trials

| Name of experiment | Sample | Trial A | | Trial B | | Trial C | |
|--------------------|---|-----------------------|------------------|-----------------------|------------------|-----------------------|------------------|
| | | Measured value [mg/L] | c/c ₀ | Measured value [mg/L] | c/c ₀ | Measured value [mg/L] | c/c ₀ |
| UF I A-C | Effluent | 26.7 | 1.0 | 30.2 | 1.0 | | |
| | Effluent + UF | 25.2 | 0.9 | 28.1 | 0.9 | | |
| | Effluent + 10 mg/L O ₃ | 23.2 | 0.9 | 27.3 | 0.9 | | |
| | Effluent + 10 mg/L O ₃ + UF | 23.6 | 0.9 | 26.7 | 0.9 | | |
| | 2 mg/L Fe ³⁺ | 25.5 | 1.0 | 29.3 | 1.0 | | |
| | 2 mg/L Fe ³⁺ +UF | 25.2 | 0.9 | 27.7 | 0.9 | | |
| | 2 mg/L Fe ³⁺ + 10 mg/L O ₃ | 24.6 | 0.9 | 26.7 | 0.9 | | |
| | 2 mg/L Fe ³⁺ + 10 mg/L O ₃ + UF | 23.1 | 0.9 | 25.7 | 0.9 | | |
| | 6 mg/L Fe ³⁺ | 23.1 | 0.9 | 28.0 | 0.9 | | |
| | 6 mg/L Fe ³⁺ +UF | 23.3 | 0.9 | 27.0 | 0.9 | | |
| UF II A-C | 6 mg/L Fe ³⁺ + 10 mg/L O ₃ | 22.6 | 0.8 | 25.7 | 0.9 | | |
| | 6 mg/L Fe ³⁺ + 10 mg/L O ₃ + UF | 22.4 | 0.8 | 25.2 | 0.8 | | |
| | Effluent | 30.1 | 1.0 | 34.4 | 1.0 | 31.1 | 1.0 |
| | Effluent + UF | 29.1 | 1.0 | 32.3 | 0.9 | 28.3 | 0.9 |
| | Effluent + 2mg/L O ₃ | 29.7 | 1.0 | 34.2 | 1.0 | 29.9 | 1.0 |
| | Effluent + 2mg/L O ₃ + UF | 27.8 | 0.9 | 32.0 | 0.9 | 27.6 | 0.9 |
| | 2 mg/L Fe ³⁺ | 29.2 | 1.0 | 33.1 | 1.0 | 28.4 | 0.9 |
| | 2 mg/L Fe ³⁺ +UF | 28.0 | 0.9 | 31.7 | 0.9 | 25.8 | 0.8 |
| | 2 mg/L Fe ³⁺ + 2mg/L O ₃ | 28.5 | 0.9 | 33.9 | 1.0 | 30.6 | 1.0 |
| | 2 mg/L Fe ³⁺ + 2mg/L O ₃ + UF | 27.6 | 0.9 | 32.8 | 1.0 | 27.9 | 0.9 |

| | | | | | | | |
|---------------|--|------|-----|------|-----|------|-----|
| | 6 mg/L Fe ³⁺ | 27.2 | 0.9 | 31.9 | 0.9 | 30.0 | 1.0 |
| | 6 mg/L Fe ³⁺ +UF | 26.6 | 0.9 | 30.2 | 0.9 | 26.2 | 0.8 |
| | 6 mg/L Fe ³⁺ 2mg/L O ₃ | 27.7 | 0.9 | 32.5 | 0.9 | 26.2 | 0.8 |
| | 6 mg/L Fe ³⁺ 2mg/L O ₃ + UF | 26.5 | 0.9 | 31.4 | 0.9 | 25.2 | 0.8 |
| | Effluent | 27.8 | 1.0 | 31.5 | 1.0 | | |
| | Effluent + UF | 27.6 | 1.0 | 27.6 | 0.9 | | |
| | 2 mg/L Fe ³⁺ | 27.3 | 1.0 | 29.2 | 0.9 | | |
| | 2 mg/L Fe ³⁺ +UF | 26.6 | 1.0 | 27.8 | 0.9 | | |
| | 2 mg/L Fe ³⁺ + 2mg/L O ₃ | 27.4 | 1.0 | 28.5 | 0.9 | | |
| | 2 mg/L Fe ³⁺ + 2 mg/L O ₃ + UF | 26.0 | 0.9 | 28.4 | 0.9 | | |
| UF III A-B | 2 mg/L Fe ³⁺ + 4 mg/L O ₃ | 26.5 | 1.0 | 25.1 | 0.8 | | |
| | 2 mg/L Fe ³⁺ + 4 mg/L O ₃ + UF | 26.0 | 0.9 | 26.7 | 0.8 | | |
| | 2 mg/L Fe ³⁺ + 6 mg/L O ₃ | 26.4 | 0.9 | 28.6 | 0.9 | | |
| | 2 mg/L Fe ³⁺ + 6 mg/L O ₃ + UF | 25.7 | 0.9 | 26.6 | 0.8 | | |
| | 2 mg/L Fe ³⁺ + 8 mg/L O ₃ | 25.6 | 0.9 | 27.1 | 0.9 | | |
| | 2 mg/L Fe ³⁺ + 8 mg/L O ₃ + UF | 25.0 | 0.9 | 25.6 | 0.8 | | |
| | 2 mg/L Fe ³⁺ + 10 mg/L O ₃ | 25.3 | 0.9 | 25.9 | 0.8 | | |
| | 2 mg/L Fe ³⁺ + 10 mg/L O ₃ + UF | 24.8 | 0.9 | 25.6 | 0.8 | | |
| | Effluent | 29.1 | 1.0 | 30.0 | 1.0 | | |
| | Effluent + UF | 27.4 | 0.9 | 27.5 | 0.9 | | |
| | 6 mg/L Fe ³⁺ | 26.6 | 0.9 | 28.2 | 0.9 | | |
| | 6 mg/L Fe ³⁺ +UF | 26.0 | 0.9 | 24.9 | 0.8 | | |
| UF IV A-B | 6 mg/L Fe ³⁺ + 2 mg/L O ₃ | 27.0 | 0.9 | 26.0 | 0.9 | | |
| | 6 mg/L Fe ³⁺ + 2 mg/L O ₃ + UF | 25.3 | 0.9 | 27.2 | 0.9 | | |
| | 6 mg/L Fe ³⁺ + 6 mg/L O ₃ | 25.9 | 0.9 | 25.7 | 0.9 | | |
| | 6 mg/L Fe ³⁺ + 6 mg/L O ₃ + UF | 24.8 | 0.9 | 25.9 | 0.9 | | |
| | 6 mg/L Fe ³⁺ + 10 mg/L O ₃ | 25.0 | 0.9 | 23.9 | 0.8 | | |
| | 6 mg/L Fe ³⁺ + 10 mg/L O ₃ + UF | 23.8 | 0.8 | 24.9 | 0.8 | | |
| UF V A-C | Effluent | 28.8 | 1.0 | 32.3 | 1.0 | 28.6 | 1.0 |
| | Effluent + UF | 27.2 | 0.9 | 28.0 | 0.9 | 27.9 | 1.0 |
| | 4 mg/L Fe ³⁺ | 27.5 | 1.0 | 30.1 | 0.9 | 28.5 | 1.0 |
| | 4 mg/L Fe ³⁺ +UF | 25.9 | 0.9 | 27.6 | 0.9 | 27.7 | 1.0 |
| | 4 mg/L Fe ³⁺ + 2 mg/L O ₃ | 27.8 | 1.0 | 28.9 | 0.9 | 27.5 | 1.0 |

| | | | | | | |
|--|------|-----|------|-----|------|-----|
| 4 mg/L Fe ³⁺ + 2 mg/L O ₃ + UF | 25.6 | 0.9 | 26.0 | 0.8 | 26.0 | 0.9 |
| 4 mg/L Fe ³⁺ + 6 mg/L O ₃ | 26.2 | 0.9 | 27.6 | 0.9 | 26.7 | 0.9 |
| 4 mg/L Fe ³⁺ + 6 mg/L O ₃ + UF | 23.9 | 0.8 | 25.2 | 0.8 | 24.8 | 0.9 |
| 4 mg/L Fe ³⁺ + 10 mg/L O ₃ | 24.8 | 0.9 | 25.4 | 0.8 | 24.0 | 0.8 |
| 4 mg/L Fe ³⁺ + 10 mg/L O ₃ + UF | 23.6 | 0.8 | 23.3 | 0.7 | 24.3 | 0.8 |

Table 40: COD_f of untreated Ruhleben secondary effluent and Ruhleben secondary effluent with 4 mg Fe³⁺/L and different ozone dosages (0-10 mg O₃/L) – results of BW trials

| Name of experiment | Sample | Trial 1 | | Trial 2 | | Trial 3 | |
|--------------------|---|-----------------------|------------------|-----------------------|------------------|-----------------------|------------------|
| | | Measured value [mg/L] | c/c ₀ | Measured value [mg/L] | c/c ₀ | Measured value [mg/L] | c/c ₀ |
| BW I A/C | Effluent | 32.2 | 1.00 | 28.8 | 1.00 | | |
| | Effluent + UF 1 st permeate | 30.8 | 0.96 | 27.2 | 0.94 | | |
| | Effluent + UF 3 rd permeate | 30.4 | 0.94 | 27.5 | 0.95 | | |
| | Effluent + UF 5 th permeate | 30.3 | 0.94 | 27.4 | 0.95 | | |
| BW I B/D | 4 mg/L Fe ³⁺ + 6 mg/L O ₃ | 27.8 | 0.86 | 25.7 | 0.89 | | |
| | 4 mg/L Fe ³⁺ + 6 mg/L O ₃ + UF 1 st permeate | 27.0 | 0.84 | 23.6 | 0.82 | | |
| | 4 mg/L Fe ³⁺ + 6 mg/L O ₃ + UF 3 rd permeate | 27.2 | 0.84 | 24.5 | 0.85 | | |
| | 4 mg/L Fe ³⁺ + 6 mg/L O ₃ + UF 5 th permeate | 28.2 | 0.88 | 22.8 | 0.79 | | |
| BW II | Effluent | | | 24.2 | 1.00 | 29.3 | 1.00 |
| BW II A/C | 4 mg/L Fe ³⁺ | | | 22.2 | 0.92 | 27.0 | 0.92 |
| | 4 mg/L Fe ³⁺ + UF 1 st permeate | | | 20.3 | 0.84 | 26.2 | 0.89 |
| | 4 mg/L Fe ³⁺ + UF 3 rd permeate | | | 21.2 | 0.88 | 26.3 | 0.90 |
| | 4 mg/L Fe ³⁺ + UF 5 th permeate | | | 23.6 | 0.98 | 25.6 | 0.87 |
| BW II B/D | 4 mg/L Fe ³⁺ + 6 mg/L O ₃ | | | 21.6 | 0.89 | 25.7 | 0.88 |
| | 4 mg/L Fe ³⁺ + 6 mg/L O ₃ + UF 1 st permeate | | | 19.7 | 0.81 | 22.6 | 0.77 |
| | 4 mg/L Fe ³⁺ + 6 mg/L O ₃ + UF 3 rd permeate | | | 18.8 | 0.78 | 23.5 | 0.80 |

| | | | | | | | |
|---------------|--|------|------|------|------|------|------|
| | 4 mg/L Fe ³⁺ + 6 mg/L O ₃ + UF 5 th permeate | | | 22.3 | 0.92 | 23.8 | 0.81 |
| BW III | Effluent | 29.7 | 1.00 | 28.2 | 1.00 | | |
| | 4 mg/L Fe ³⁺ | 26.7 | 0.90 | 27.0 | 0.96 | | |
| BW III A/D | 4 mg/L Fe ³⁺ + UF 1 st permeate | 26.7 | 0.90 | 24.7 | 0.88 | | |
| | 4 mg/L Fe ³⁺ + UF 3 rd permeate | 26.3 | 0.89 | 25.4 | 0.90 | | |
| | 4 mg/L Fe ³⁺ + UF 5 th permeate | 27.0 | 0.91 | 25.6 | 0.91 | | |
| | 4 mg/L Fe ³⁺ + 2 mg/L O ₃ | 27.2 | 0.92 | 26.7 | 0.95 | | |
| BW III B/E | 4 mg/L Fe ³⁺ + 2 mg/L O ₃ + UF 1 st permeate | 26.1 | 0.88 | 25.7 | 0.91 | | |
| | 4 mg/L Fe ³⁺ + 2 mg/L O ₃ + UF 3 rd permeate | 25.6 | 0.86 | 25.6 | 0.91 | | |
| | 4 mg/L Fe ³⁺ + 2 mg/L O ₃ + UF 5 th permeate | 26.2 | 0.88 | 24.6 | 0.87 | | |
| | 4 mg/L Fe ³⁺ + 6 mg/L O ₃ | 25.9 | 0.87 | 23.4 | 0.83 | | |
| BW III C/F | 4 mg/L Fe ³⁺ + 6 mg/L O ₃ + UF 1 st permeate | 24.3 | 0.82 | 23.1 | 0.82 | | |
| | 4 mg/L Fe ³⁺ + 6 mg/L O ₃ + UF 3 rd permeate | 24.3 | 0.82 | 23.7 | 0.84 | | |
| | 4 mg/L Fe ³⁺ + 6 mg/L O ₃ + UF 5 th permeate | 23.8 | 0.80 | 23.9 | 0.85 | | |
| | 4 mg/L Fe ³⁺ + 10 mg/L O ₃ | | | 23.8 | 0.84 | | |
| BW III G | 4 mg/L Fe ³⁺ + 10 mg/L O ₃ + UF 1 st permeate | | | 21.8 | 0.77 | | |
| | 4 mg/L Fe ³⁺ + 10 mg/L O ₃ + UF 3 rd permeate | | | 22.8 | 0.81 | | |
| | 4 mg/L Fe ³⁺ + 10 mg/L O ₃ + UF 5 th permeate | | | 22.8 | 0.81 | | |