

PROJECT AMEDEUS
“ACCELERATE MEMBRANE DEVELOPMENT
FOR URBAN SEWAGE PURIFICATION”

FINAL ACTIVITY REPORT



SIXTH FRAMEWORK PROGRAMME
Priority 1.1.6.3
“GLOBAL CHANGE AND ECOSYSTEMS”
SPECIFIC TARGETED RESEARCH PROJECT





Project acronym: AMEDEUS
Project full title: Accelerate Membrane Development
for Urban Sewage Purification
Proposal/Contract no.: 018328 AMEDEUS
Instrument: STREP
Priority: Global Changes and Ecosystems
Duration: Oct. 2005 – May 2009

PROJECT AMEDEUS
“ACCELERATE MEMBRANE DEVELOPMENT
FOR URBAN SEWAGE PURIFICATION”
FINAL ACTIVITY REPORT

Authors

Boris Lesjean (Coordination)	Berlin Centre of Competence for Water (KWB)
Aurélie Grelot	Anjou Recherche (AR)
Julie Jimenez	Anjou Recherche (AR)
Heleen De Wever	Flemish Institute for Technological Research (VITO)
Etienne Brauns	Flemish Institute for Technological Research (VITO)
Wouter De Wilde	Aquafin (AQF)
Lucas Maes	Aquafin (AQF)
Vera Iversen	Technical University of Berlin (TUB)
Renata Mehrez	Technical University of Berlin (TUB)
Jürgen Krisam	A3 water solutions (A3)
Daniel Vilim	Envi-Pur (ENVI)
Martin Heijnen	Inge (INGE)
Olivier Lorain	Polymem (POLYM)
Enrico Fatarella	Tecnotessile (TTX)
Greg Leslie	University of New South Wales (UNSW)

Report delivery date and version

16 February 2010

Version 1.0

Public report

ISBN: 978-3-9811684-6-4



SIXTH FRAMEWORK PROGRAMME
Priority 1.1.6.3
“GLOBAL CHANGE AND ECOSYSTEMS”

SPECIFIC TARGETED RESEARCH PROJECT





Project acronym: AMEDEUS
Project full title: Accelerate Membrane Development for Urban Sewage Purification
Proposal/Contract no.: 018328 AMEDEUS
Instrument: STREP
Priority: Global Changes and Ecosystems
Duration: Oct. 2005 – May 2009

PROJECT AMEDEUS
“ACCELERATE MEMBRANE DEVELOPMENT
FOR URBAN SEWAGE PURIFICATION”
FINAL ACTIVITY REPORT

Quality Management

	Name	Company	Date
Edition and final draft	B. Lesjean	KWB	07.08.2009
1 st QA review	A. Drews	TUB	17.08.2009
2 nd QA review	H. De Wever	VITO	24.08.2009
3 rd QA review	L. Maes	AQF	31.08.2009
4 th QA review	A. Tazi-Pain	AR	14.09.2009

**Revision: Final
Public report**

Please refer to this report as:
AMEDEUS project final report, ISBN: 978-3-9811684-6-4, 2009, 120 pages.

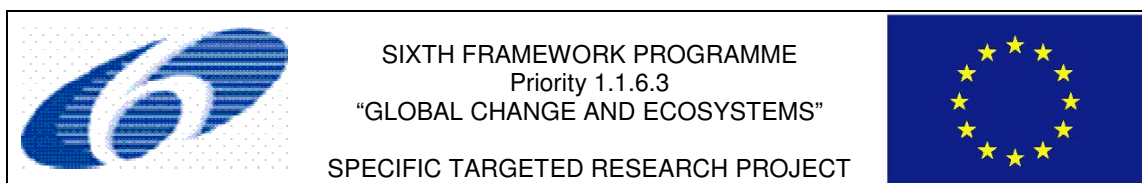

Executive summary

Project objectives and consortium

Over the past decade, membrane bioreactors have been increasingly implemented to purify municipal wastewater. However, even with submerged modules which offer the lowest costs, the membrane bioreactor (MBR) technology remains in most cases more expensive than conventional activated sludge processes. In addition, the European municipal MBR market is to date a duopoly of two non-European producers, despite many initiatives to develop local MBR filtration systems.

In 2005, the European Commission decided to finance four projects dedicated to further technological development of MBR process: the four projects AMEDEUS, EUROMBRA, MBR-TRAIN and PURATREAT were implemented from October 2005 up to December 2009 and joined their efforts within the coalition "MBR-Network" (www.mbr-network.eu).

The present report synthesises the major outcomes of the project AMEDEUS, conducted from October 2005 up to May 2009. The AMEDEUS research project aimed at tackling both issues of accelerating the development of competitive European MBR filtration technologies, as well as increasing acceptance of the MBR process through decreased capital and operation costs. The project targets the two market segments for MBR technology in Europe: the construction of small plants (semi-central, 50 to 2,000 population equivalent or p.e., standardized and autonomous), and the medium-size plants (central, up to 100.000 p.e.) for plant upgrade.

Table 1. List of participants in the AMEDEUS project.

Partner Name	Acronym	Country
R&D centers		
Coordination: Berlin Centre of Competence for Water	KWB	Germany
Flemish Institute for Technological Research	VITO	Belgium
Tecnotessile	TTX	Italy
Universities		
Berlin University of Technology, TU Berlin	TUB	Germany
University of New South Wales	UNSW	Australia
End-Users		
Anjou Recherche (Veolia Water)	AR	France
Aquafin	AQF	Belgium
Small and medium enterprises (SMEs)		
A3 water solution	A3	Germany
Polymem	POLY	France
Inge	INGE	Germany
Envi-Pur	ENVI	Czech Republic

Technological development of new MBR systems was fostered by a consortium composed of 11 partners (Table 1), of which four are small and medium enterprises (SMEs) proposing novel concepts of low-cost and high-performance filtration systems. Two end-users, three non-profit research institutions and two universities, all of them well versed in research and development (R&D) in the MBR field, investigated solutions to reduce operational costs such as fouling control, membrane cleaning optimisation and aeration decrease, or to optimise

capital costs through improved implementation of the membrane bioreactor process. Furthermore, an analysis of the potential for standardisation was performed, and a technology transfer towards Southern, Central and Eastern Europe was organised in order to facilitate the penetration of these new markets. AMEDEUS aimed to achieve concrete and realistic technological breakthroughs for the MBR technology, and to improve the current process engineering and operation practices. It contributed to increasing the competitiveness of the European MBR industry and increased the acceptance in the municipal wastewater sector towards this rather high-tech process.

Progress towards objectives

The AMEDEUS project was completed according to the work programme, and all objectives identified in the scope of the project could be matched. The main outcomes of the project are presented for each original objective in this report.

The progress towards objectives is summarized below.

Objective 1. Minimisation of membrane fouling with chemical additive

30 different chemicals were screened with regards to their potential for flux enhancement and / or fouling control in MBR. Their impact on SMP removal, particle size distribution and fouling propensity of the sludge was investigated in jar and bench tests, but also their biotoxic impact and optimum concentrations were studied. The most promising chemicals (2 synthetic cationic polymers and one biopolymer) were investigated in long term trials in two identical MBR pilot units (1.6m³ and 22m² membrane module each), operated side by side and fed by real municipal sewage. While flocculants were dosed into one system, the other served as a reference. While the biopolymer did not improve the filtration performances, the two cationic polymers proved to retard the TMP jump and to decrease the requirements for chemical cleaning. The related additional operation costs were in the range of 0.6 – 2.5 € per cubic meter of withdrawn excess sludge. For a typical SRT of about 20 d, 1-3 €cent per cubic meter treated wastewater would be incurred by the use of polymers, which would increase the operational costs by less than 10 % for larger MBR plants like Varsseveld or Nordkanal.

Objective 2. Development of on-line sensors for fouling propensity of MBR sludge

Two on-line analysers were developed to monitor potential fouling causing substances or fouling propensity of MBR sludge. The first approach was based on a physical test (assessment of sludge filterability fingerprint, VITO Fouling Measurement) and another approach was based on chemical analyses of the potential organic fouling substances – proteins and polysaccharides– in the sludge interstitial water after particle retention (Photometrical EPS SIA sensor). Due to the strong complementarities of both approaches, their simultaneous implementation as inputs for an advanced control system could be highly interesting.

Objective 3. Improving membrane cleaning

Investigations were performed at lab scale and pilot scale to identify chemical reagents alternative to chlorine with 3 different membrane types supplied by the project partners A3 Water Solutions, Polymem and Inge. The results highlight that the composition of the internal fouling could vary according to the used membrane and the operating conditions. In addition, it appears that the cleaning products do not always have the same effectiveness on all types of membranes and the cleaning protocols have to be adapted following the cleaning reagent. Chlorine was efficient on all the membranes but its effectiveness as for the other cleaning reagents was affected when sludge was accumulated into or at the membrane surface. Following the results, it seems that hydrogen peroxide could be a best alternative to chlorine but must be preferentially used with a backwash step, so that the cleaning product comes directly in contact with the internal fouling inside the membrane pores, without dealing with the external fouling at the surface of the membrane.

Objective 4. Modelling of biological process

The MBR process was calibrated on a large range of wastewater types (1mm screened vs. primary settled wastewater) and operation conditions (15 d vs. 40 d sludge age). The ASM1 model was able to predict correctly the MBR performances at 15 day sludge age for two different influents with the same calibration kinetic parameters. In comparison with a CAS process, the nitrification and denitrification oxygen half saturation constants are different because of a better oxygen transfer improved by the smaller floc morphology. In conditions of higher sludge age (40 days), the ASM1 model was however not able to fully reproduce all biological patterns, and further development would be required. Finally the permeate COD prediction was independent of the operating conditions and mainly related to the membrane cut-off.

Objective 5. Evaluation of the impact of primary sedimentation

The model calibrated at 15 day sludge age was used to assess the impact of primary sedimentation in plant design and operation. The results highlighted that the presence of a settler would result in a total sludge production increase of +19%, biological oxygen demand decrease by 15% and a reactor volume decrease by 30%. Moreover, if a sludge treatment by anaerobic digestion is considered, the production of methane would increase by 28%. Lastly, it seems that the large particles (like sand) not retained by the screen can damage the membranes. The presence of a settler (or an advanced sand trap) would therefore increase the membrane life. Although no full-scale MBR plant was purposely designed in Europe with primary settler and anaerobic digestion, it seems therefore that this option should be considered for the larger plants (typically above 50,000 pe).

Objective 6. Cost-effective positioning of submerged modules

Submerged MBR modules can be implemented in two different ways. In the integrated system, the membrane modules are set up directly in the aerated biological tank, whereas in the separate system, they are submerged in a separate tank which is dedicated to filtration only. An extensive review of the current practices and the pros and cons of the two configurations was performed. In brief, if the integrated system option seems to lead to lower investment and operation costs, the separate system option enables more operation flexibility and control. A decision tree between the two systems is proposed depending on local project conditions.

Objective 7. On-line data acquisition and advanced filtration control system

An operational advanced control system (ACS) was developed which was validated on a MBR pilot unit with a gradual increase in complexity of selected input and output parameters. The ACS had an understandable interface and allowed for clear logging of changes in operational conditions. A first series of demonstration tests was performed on a MBR pilot unit. This showed that the MBR-VFM measurements correlated well with on-line permeability and are thus a suitable input parameter for the ACS. The tests also showed that an average 20% reduction in membrane aeration requirements could be achieved, although this sometimes went at the expense of a stronger permeability decline, and could thus result in a higher cleaning frequency.

Objective 8. Optimised integration and control of MBR system in case of plant refurbishment

Dual configurations, combining conventional activated sludge (CAS) technology and MBR-technology are a means to increase the cost-effectiveness of the refurbishment. During the project, the technical feasibility and the market potential of 2 schemes integrating this idea were investigated. An advanced control system for the flow repartition between the MBR and the CAS line was developed with desk-top analysis, before full-scale demonstration. The design and operation guidelines, as well as the performances of a second CAS-MBR configuration were assessed at pilot scale. Finally, a study on market potential targeting EU

Accession and Associated Countries, was complemented by an engineering study performed for the renovation of a real full-scale plant of 120,000 pe in Bulgaria.

Objective 9. Standardisation of MBR technology

Based on an extensive survey of the MBR industry, a comprehensive analysis was performed on the market interests/expectations and technical potential of going through a standardisation process of MBR technology in Europe. The report of this study, the White Paper was discussed and endorsed by the European MBR industry and is considered as a public discussion document on MBR standardisation in Europe. It increased awareness and interest in the subject and, according to the outcomes and in agreement with the European MBR industry, initiated a formal procedure of standardisation together with the Centre Européen de Normalisation (CEN).

Objective 10. Development of novel concepts of MBR filtration modules and systems

One of the key project objectives was to develop novel concepts of MBR filtration systems. Three different design approaches were proposed by the project partners A3 Water Solutions, Polymem and Inge and were then evaluated at Anjou Recherche under typical biological operating conditions.

The flat sheet technology of the company A3 Water Solutions was the more mature technology at the start of the project. The pilot tests showed that this MBR filtration technology was well adapted for operation in MBR application. The implementation of a double-deck configuration does not impact the fouling behaviour and enables to decrease substantially the air demand per membrane surface unit (SADm). In addition, satisfying and reliable fouling control was achieved with this system when operating at a net flux of $25 \text{ L}\cdot\text{h}^{-1}\cdot\text{m}^{-2}$ (20°C) with backwashes and maintenance cleanings for a relatively low SADm value of $0.2 \text{ Nm}^3\cdot\text{h}^{-1}\cdot\text{m}^{-2}$ (corresponding to $8 \text{ Nm}^3/\text{m}^3_{\text{permeate}}$, competitive with current commercial MBR systems).

The MBR technologies developed in the project by the companies Polymem and Inge were completely new MBR filtration concepts, respectively a carterised hollow fibre module and a Fibre Sheet module, and would require further developments before possible commercialisation. With regards to the Polymem technology, the first tested fibres were subject to breakages leading to permeate contamination. The second fibres (with a larger diameter) supplied by Polymem were more resistant and therefore more adapted to MBR applications but longer tests are still required to validate their use. The Polymem module configuration was also not optimal to achieve good fouling control: the packing density of the tested bundles was too high, leading to irreversible entrapment of the sludge into the bundles. With regards to the Inge technology, membrane breakage was also problematic on the different tested modules. Clogging was avoided with this technology design but it appeared that the membrane surface was too rough leading to some sludge deposit.

Objective 11. Development of MBR modules with textile filtration media

The project team undertook the development of MBR filtration systems using non woven textile as filtration media. The characterisation of standard nonwovens showed that they have limitations for application in MBR: larger pore sizes ($> 10 \mu\text{m}$) with a large pore distribution. In order to easily solve the limits of the textile filtration media electrospinning combined with plasma treatment seems to be a promising option. The coating of nanoweb and the functionalisation by means of plasma treatments allows reducing some critical points, such as porosity and roughness mainly responsible for the low filtration performances. Furthermore, plasma is able to enhance the permeability of treated nonwovens because of the reduction of the superficial tension. Concerning the critical flux measurements it was found that a combination of flocculants and textile shows promising results if large flocs can be sustained. The overlapping between floc size and pore size seems to be detrimental for the operation of textile bioreactors (TBR). During long term operation with TBR the nanocoated material showed better results than the coarse nonwoven. The filtration performance with flocculant was however not as good as during the

test cell trials, which indicated that fluxes up to 150 L/(m²h) might be possible. Production cost analysis at industrial scale performed for nanocomposite membranes showed that the overall cost would be 5 €/m² to be compared with about 14 €/m² for conventional microfiltration membranes.

Objective 12. Development of turn-key standardised MBR plants and filtration units

A range of turn-key containerised MBR units was engineered for small communities of 50 up to 2,000 pe. In addition, in case of larger plants or when retrofitting is an option, an engineering study for the production of the filtration units only was performed. Cost estimations for the renovation of a real full-scale plant of 1,000 pe in the Czech Republic were performed.

Objective 13. Results integration

A dedicated objective was to prepare and facilitate the commercialisation or exploitation of the project technologies and developments while enhancing the penetration of the MBR technologies in new European markets. Several initiatives were conducted to address this objective: (i) an analysis of the European MBR market at the start and the end of the project was performed, with a focus on the largest plants (the greater share of the market); (ii) results were “integrated” within AMEDEUS, and also with the project EUROMBRA and the other projects of the coalition of European projects MBR-Network through six “Liaison Groups” (LG) addressing selected topics; and (iii) the project developments were regularly reviewed and compared with current patent: 11 items of exploitable knowledge were identified and at least 4 patents were filed.

Objective 14. Dissemination

The MBR-Network projects performed extensive communication of the project results and supported the construction of a network of expertise on the MBR technology within Europe. The various initiatives undertaken (in particular the common visual identity, the joint press-releases, the numerous workshops and the web-platform) were very efficient in touching a broad public of water and membrane professionals. Nine public workshops were organised at the occasion of international conferences, as well as one final workshop gathering more than 220 water professionals. More than 100 communications, manuscripts and conference talks were presented, among which more than 20 scientific papers. The web-site www.mbr-network.eu has proven to be a powerful and sustainable communication tool and source of information for the international MBR community, and will be maintained to play this role after termination of the projects.

Project information

Project AMEDEUS “Accelerate Membrane Development for Urban Sewage Purification”

Contract N°. 018328 – AMEDEUS

Duration 01/10/2005 – 31/05/2009

www.mbr-network.eu

Contact Coordination

Boris Lesjean

Berlin Centre of Competence for Water

Cicerostr. 24, D-10709 Berlin

boris.lesjean@kompetenz-wasser.de



Table of Content

Executive summary	4
Table of Content.....	9
List of Figures.....	10
List of Tables	12
Glossary	13
1 Objective 1. Minimisation of membrane fouling with chemical additive.....	14
2 Objective 2. Development of on-line sensor for organic foulants.....	21
3 Objective 3. Improving membrane cleaning	29
4 Objective 4. Modelling of biological process.....	37
5 Objective 5. Evaluation of the impact of primary sedimentation	42
6 Objective 6. Cost-effective positioning of submerged modules.	47
7 Objective 7. On-line data acquisition and advanced filtration control system.....	52
8 Objective 8. Optimised integration and control of MBR for plant refurbishment.	57
9 Objective 9. Standardisation of MBR technology.	67
10 Objective 10. Development of novel concepts of MBR filtration systems.....	72
11 Objective 11. Development of MBR modules with textile filtration media.....	83
12 Objective 12. Development of turn-key standardised MBR units.	88
13 Objective 13. Results integration.....	92
14 Objective 14. Dissemination.....	96
15 Bibliographic references	101
16 Project related publications.....	104
17 Public project reports	106
18 Publishable results.....	107
19 Acknowledgement	119

List of Figures

Figure 1. Flocculation of sludge by multivalent cations	14
Figure 2. Flow sheet of the filtration test cell	15
Figure 3. a) Set-up of the parallel pilot plants b) Flow sheet of one system	16
Figure 4. Resistance during filtration	17
Figure 5. TMP evolution for reference plant and polymer (KD 452) added plant	19
Figure 6. Operation cost of several flux enhancers depending on sludge age conditions.....	20
Figure 7. MBR-VFM set-up	21
Figure 8. Schematic representation of MBR-VFM measurement protocol.....	22
Figure 9. Evolution in on-line TMP measurement and reversible fouling fingerprints.	23
Figure 10. Scheme of EPS sensor system; EPS sensor installed in the MBR unit.	24
Figure 11. Variation of PR concentration in sludge filtrate of MBR.	26
Figure 12. Variation of PS concentration in sludge filtrate of MBR.....	27
Figure 13. Design of the pilot to measure the permeability of flat sheet membranes.....	29
Figure 14. Design of the pilot to measure the permeability HF modules and FiSh sheets.....	29
Figure 15. Pilot diagram to foul two flat sheet membranes with sludge supernatant.....	30
Figure 16. Pilot diagram to foul three HF bundles or FiSh modules with sludge supernatant	30
Figure 17. Calibration of ammonia and nitrates, and results from size distribution of flocs....	41
Figure 18. Comparison between sludge generated in both pilots at SRT 15 days	43
Figure 19. Floc size distribution comparison between settled and screened pilots	43
Figure 20. Comparisons of ADM1 fractions for the different sludges considerate	44
Figure 21. Results of steady-state simulations of anaerobic digestion	45
Figure 22. Observations of membranes from screened pilot at the end of the study	46
Figure 23. Conceptual representation of separate and integrated configuration.	48
Figure 24. Evolution in integrated and separate submerged MBRs in time.	49
Figure 25. Decision tree for submerged MBR design.....	52
Figure 26. Concept of advanced control system (ACS) approach.....	53
Figure 27. Advanced Control System (ACS) scheme.....	54
Figure 28. Evolution in flux and permeability during test block 2.	55
Figure 29. Evolution in flux and permeability during dynamic flux operation.	56
Figure 30. Dual 1 configuration	58
Figure 31. Dual 2 configuration	58
Figure 32. N load in the WWTP effluent during dry weather: previous and new control.....	59
Figure 33. Removal performance of primary clarifier 1 with and without coagulant dosage ..	60
Figure 34. Schematic flow field in the anoxic and aerobic tank of the MBR-lane of Schilde ..	60
Figure 35. MLSS concentration and resulting effluent turbidity during period 3.	61
Figure 36. Connection rate to the sewerage network and to WWTPs in the study region.....	63
Figure 37. Treatment levels of wastewater collected by sewers in the study region.....	63
Figure 38. Annualised cost estimates of the main refurbishment options, Bulgaria	64
Figure 39. Annualised cost estimates of the main refurbishment options, Cyprus	65
Figure 40. Cost comparison for the renovation scenarios of the Veliko Tarnovo WWTP	66
Figure 41. Emerging market of module replacement.....	67
Figure 42. Pilot plant configuration to test novel MBR systems.	73
Figure 43. A3 Water Solution MBR module concept	74
Figure 44. SADp for current market technologies and comparison with A3 technology	75
Figure 45. A3 membrane performances with peak flows	76
Figure 46. Design of the A3 triple deck module	77
Figure 47. Installation of the A3 triple deck module in the pilot plant of Seelscheid WWTP ..	77
Figure 48. Design of Module M90X	77

Figure 49. Polymem module photos.....	78
Figure 50. inge multitubular sheets.....	80
Figure 51. inge module.....	80
Figure 52. lab scale FiSh manufacturing facility.....	80
Figure 53. Resistance and flux evolution for selected operating conditions.....	82
Figure 55. Picture of the electrospinning prototype designed and constructed by TTX.....	84
Figure 56. SEM picture of the NY6 nanocomposite membranes.....	85
Figure 57. Stable operation if re-flocculation is applied.....	87
Figure 58. Filtration performance of coarse and nanocoated nonwoven Novatexx.....	87
Figure 59. Flow diagram of containerised WWTP.....	90
Figure 60. 3D picture of containerised system (200 pe).....	91
Figure 61. Plant overview.....	92
Figure 62. Mechanical pre-treatment.....	92
Figure 63. Evolution of MBR market in Europe.....	93
Figure 64. Capacity distribution of European MBR plants.....	93
Figure 65. Geographical distribution of MBR market in Europe.....	94
Figure 66: MBR-Network workshop in Velke Belovice, Czech Republic (1 October 2008)....	98
Figure 67: Final MBR-Network workshop. Poster award winners and international jury.....	98
Figure 68. Frequentation statistics of www.mbr-network.eu in April 2009.	99
Figure 69. Evolution of total monthly visits and consulted pages of MBR-Network.....	100

List of Tables

Table 1. List of participants in the AMEDEUS project	4
Table 2. Selected additives and their positive or negative impact on parameters	20
Table 3. Sensitivity, LOD, LOQ, ME of different methods for protein determination.	25
Table 4. Comparison of MBR-VFM and EPS-SIA sensors	28
Table 5. Cleaning reagents investigated in the study	31
Table 6. Cleaning tests with the A3 membrane (2h soaking)	33
Table 7. Cleaning tests with the Polymem membrane (2h soaking)	34
Table 8. Cleaning tests with the inge membrane	36
Table 9. COD experimental fractionation.....	38
Table 10. Steady-state simulations results and calibration at SRT 15 days	39
Table 11. Calibration parameters comparison for SRT 15 and 40 days.....	40
Table 12. “resource oriented” comparison of the two pre-treatment schemes	46
Table 13. Qualitative comparison of costs between the two pre-treatment schemes.....	47
Table 14. Comparison of costs for the Kaarst and Varsseveld MBR plants.	51
Table 15. Average aeration rates (Nm ³ /h) during the different test periods.....	56
Table 16. Summary of impacts of MBR filtration module standardisation	69
Table 17. Technical factors towards interchangeable MBR modules	70
Table 18. Summary of main membrane monitoring methods.....	71
Table 19. Mean feed water quality.....	72
Table 20. Mean biological operating conditions.....	73
Table 21. Bundles configurations implemented in the module.....	79
Table 22. Summary of the results	79
Table 23. Treatment optimal conditions for the production of nanofibers.....	85
Table 24. Performance of the NY6 nanocomposite and conventional textile membrane	85
Table 25. Estimation of the production costs for the nanocomposite textile	86
Table 26. Characteristic of the Textile MBR modules.....	87
Table 27. Design parameters (for ISO containers).....	89
Table 28. Design pollution.....	89
Table 29. Design parameters of membrane modules.....	89
Table 30. Cost comparison of the different membrane options for the retrofitting of wwtp.....	91

Glossary

ACS	Advanced control system
ASM	Activated sludge model
CAS	Conventional activated sludge
COD	Chemical oxygen demand
DOC	Dissolved organic matter
EPC	Enhanced primary clarification
EPS	Extracellular polymeric substances
HRT	Hydraulic retention time
MBR	Membrane bioreactor
MBR-VFM	MBR VITO Fouling Measurement
ML	Mixed liquor
MLSS	Mixed liquor suspended solids
MLISS	Mixed liquor inorganic suspended solids
MLVSS	Mixed liquor volatile suspended solids
PAC	Powdered Activated Carbon
PACI	Polyaluminium Chloride
SIA	Sequential injection analysis
SMP	Soluble Microbial Products
SRT	Solid retention time
TMP	Transmembrane Pressure
TN	Total nitrogen
TS	Total solids
TSS	Total suspended solids
WWTP	Wastewater treatment Plant

Symbols

b_A	Autotrophic decay rate (d^{-1})
b_H	Heterotrophic decay rate (d^{-1})
K_{OA}	Half-saturation constant of autotrophic biomass for oxygen (gO_2/m^3)
K_{OH}	Half-saturation constant of heterotrophic biomass for oxygen (gO_2/m^3)
S_i	Soluble inert of COD fraction (g/m^3)
X_{BH}	Heterotrophic biomass of COD fraction (g/m^3)
X_{BA}	Autotrophic biomass of COD fraction (g/m^3)
X_i	Particular inert of COD fraction (g/m^3)
X_P	Particular products arising from biomass decay (g/m^3)
Y_H	Heterotrophic conversion yield ($kg\ COD/kgCOD$)
Y_{obs}	Excess sludge production yield ($kg\ VSS/kgCOD$)
μ_A	Autotrophic growth rate (d^{-1})

1 Objective 1. Minimisation of membrane fouling with chemical additive

1.1 Introduction

Membrane fouling still is one major drawback of MBR technology. The new and promising method of adding certain chemicals to the MBR mixed liquor was investigated at TU Berlin. Experiments were carried out with activated carbons, metal salts, chitosan, synthetic polymers, enzymes and starch.

The effects of these additives can generally be divided into two mechanisms: cationic flocculants cause a charge neutralisation of the negatively charged sludge flocs and thus lead to larger flocs (as shown in Figure 1). Adsorbants accumulate fouling causing solutes or colloids at their surface; this task is often realised by the addition of activated carbon / powdered activated carbon (PAC) into the MBR. In contrast to this, flocculants are thought to cause macroscopic flocs and aggregation of particles, favouring porous filtration cake layers. Nevertheless, it is reported that PAC can also lead to a structuring effect of the sludge floc and thus probably to a better filterability (Remy et al., 2009).

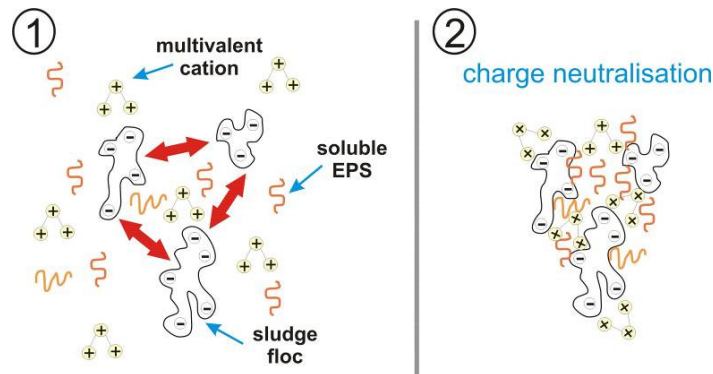

Figure 1. Flocculation of sludge by multivalent cations

Although a wide range of studies on different additives in MBR is available in literature (e.g. Ji et al., 2008; Lee et al., 2007; Munz et al., 2007) these mostly focus on the effect of just one or two additives. The use of additives is mostly based on conventional water treatments (e.g., elimination of colloids in water bodies) and each additive might play a different role in solutes and colloids removal, so it is of high importance to select more pertinent coagulants/adsorbents that can effectively increase filterability e.g. by specific removal of soluble microbial products (SMP) in MBR sludge. It is also of particular significance to understand to what extent the additives eliminate SMP substances.

On the other hand, these changes of sludge characteristics might have a negative impact on the nutrient removal due to possibly changed transport phenomena through the liquid and the floc. For conventional flocculants it is commonly known that overdosing sometimes leads to adverse effects (Bratby, 2006). Therefore, dosing beyond a certain "optimum" concentration might not only lead to higher costs for the additive but also to disturbances in the elimination performance and/or to increased fouling as the additive might not be bound into the flocs anymore but remains in the solution and causes fouling itself.

In a comprehensive and impartial screening, 30 substances of the above mentioned categories were investigated. SMP elimination potential, effects on filterability in large and small scale, respiration, oxygen transfer, nitrification and denitrification, as well as shear stability, dewaterability, and also effects of temperature, MLSS and calcium ions as well as costs were taken into account.

1.2 Material and Methods

Information concerning the 13 most extensively studied additives can be found in Table 2, together with key results of the investigations. Although a broad range of experiments were conducted, only the two main experimental setups will be described here (for more information on the other methods see references cited in the text).

Filtration test cell: Small scale filterability tests under defined and representative hydrodynamic conditions were conducted in a cross flow filtration test cell (Fig. 2) designed at the Chair of Chemical Engineering, TU Berlin (Rosenberger et al., 2001), simulating the cross flow conditions between two flat sheets in a submerged MBR plate and frame module. Channel height was 5mm for all tests conducted, but can be varied. Effective membrane area is 88cm². The test cell was operated under constant flux conditions while TMP was monitored. The cell can be aerated with different aeration intensities.

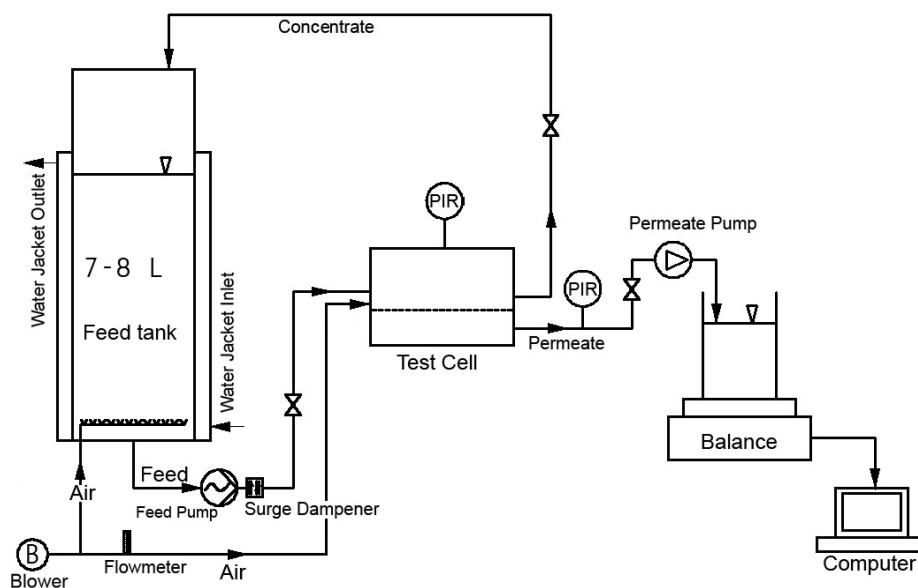

Figure 2. Flow sheet of the filtration test cell

MBR Pilot plant: In order to investigate the effect of flux enhancing chemicals under realistic (larger scale, long-term, real feed) conditions in MBRs, two identical pilot plants were set up (Figure 3). Each unit consisted of two 1m³ tanks with a working volume of approx. 0.8m³. The pilot units were located in a 20' sea container on the premises of a pumping station of the Berliner Wasserbetriebe, thus drawing combined municipal wastewater from the Berlin city centre as influent. After the settler used as sand trap for the removal of larger particles, the wastewater flowed into a stirred anoxic chamber. The following tank was aerated and equipped with a 22m² membrane module (A3 Water Solutions, Germany, PVDF, nominal pore size 0.2 μm). TMP, flux, DO, T and pH in the membrane chamber were registered online. The average chemical oxygen demand (COD) and total nitrogen (TN) concentrations of feedwater were around 780 and 95 mg/L, respectively. The hydraulic retention time (HRT), sludge retention time (SRT) and aeration rate were 7-8 hours, 13 days, and 17 Nm³/h (specific aeration demand = 0.8 Nm³/(m²h), superficial air velocity = 0.028 m/s), respectively.

The systems were in operation from October 2006 up to May 2009. While different flocculants were dosed in one system (each for approx. 3 months), the other served as a reference.

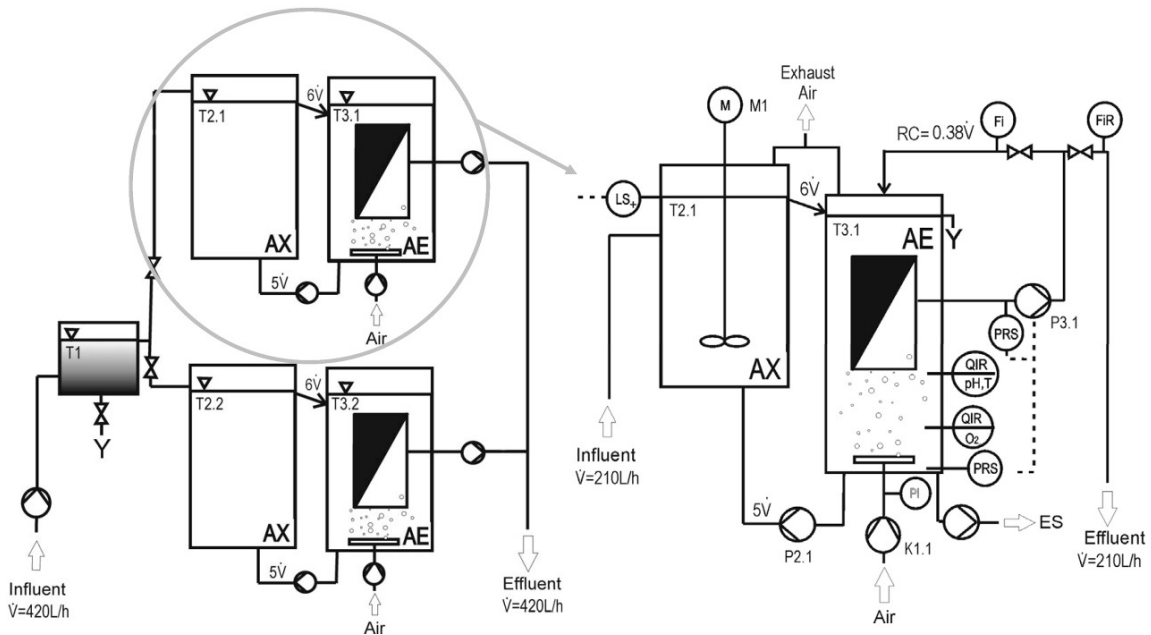

Figure 3. a) Set-up of the parallel pilot plants

b) Flow sheet of one system

1.3 Results

SMP elimination: In a series of well defined jar tests, the optimum concentration of each of the 30 additives was determined in terms of SMP-removal. Most of the tested additives showed a good to excellent ability to eliminate proteins and polysaccharides from the supernatant. Only some starches and the enzymes caused (due to their chemical composition) an increase in SMP or interfered with the analytical method and were thus excluded from further testing. 13 additives were then chosen for more elaborate studies. The selection was made according to SMP removal efficiency. In addition, at least one chemical from each category (metal salt, chitosan, activated carbon, synthetic polymer and starch) was chosen in order to evaluate different physical effects. Interestingly, the optimum concentration determined for mixed liquors originating from different treatment plants (different MBR units as well as a conventional activated sludge systems) was nearly always the same. Also the optimum concentration determined in terms of SMP removal also yielded the best results in terms of filterability, although the extent of improvement did not correlate with the eliminated amount of SMP (Koseoglu et al., 2008).

The effect of temperature, Ca^{2+} concentration and TS on the efficiency of additives in terms of SMP removal was also evaluated. It seemed that the SMP removal was altered if these parameters were varied when the applied additive concentration was below the optimal dosage. With increasing TS and temperature, the removal of supernatant compounds decreased.

Side effects on filterability and nutrient removal: In "residual tests" (5% of the optimum concentration was dissolved in pure water in order to simulate the amount of the chemical that is not bound to the flocs and remains in the liquid phase) carried out in the test cell (Figure 2) it became obvious that especially the tested starch induced strong fouling on all tested membranes (Iversen et al., 2008a).

The side effects on the biology and thus on nutrient removal were studied while monitoring the impact of the substances on the oxygen uptake and transfer rates as well as the nitrification and denitrification rates (Iversen et al., 2008a; Iversen et al., 2009a). Few

negative impacts of the various reagents were observed, except for the following chemicals. The tested polyaluminium chloride (PACl) strongly impacted on nitrification (-16 %) and denitrification rate (-43 %). The biodegradable nature of chitosan was striking in endogenous and exogenous tests. Considering the relatively high costs of this chemical, an application for wastewater treatment does thus not seem to be advisable. Also, the addition of one of the tested activated carbons strongly impacted on the oxygen uptake rate (-28%), nitrification (-90%) and denitrification rate (-43 %), due to a decrease of pH. Results show that the changes in $k_L a$ values were mostly not significant, however, a decrease of 13% in oxygen transfer was found for sludge treated with PACl.

Filterability in test cell trials: In Figure 4, the resistances due to the membrane, internal fouling and the filter cake build-up are depicted. A measurement of the reference sludge and sludge spiked with the optimum concentration of one of the respective additives was conducted within one day to account for changes of the mixed liquor. As can be seen, especially the resistance of the filter cake was strongly reduced when a flocculant was added to the mixed liquor (see also Iversen et al., 2007b). As shown by Lee et al. 2007, the biofilm architecture, especially the composition and porosity, largely changes if a flocculant is dosed into the system – thus leading to lower resistances.

Commonly, constant additive dosing is applied if an additive is dosed for flux enhancement. Yoon and Collins (2006) describe a dosing step from 0 mg/L to the found optimum concentration of 300 ppm just at the start of the experiments, followed by a daily addition to compensate for the losses due to excess sludge removal. Other authors describe similar approaches (Ying and Ping, 2006).

If the addition of a flux enhancer can be controlled by the concentration of fouling causing compounds or the fouling propensity, operation costs and chemicals can be saved. Thus the question occurs what might be the effects for slight over- or underdosing. Here, it was found that metal salts and the biopolymers chitosan and starch are tricky to dose, as over- or underdosing might cause further fouling on the membrane. Especially the overdosing of the PACl Magnasol 5108 can cause accelerated fouling compared to the untreated reference sludge (Koseoglu et al. 2008). But slight over- or underdosing of other substances was not detrimental to the filtration performances.

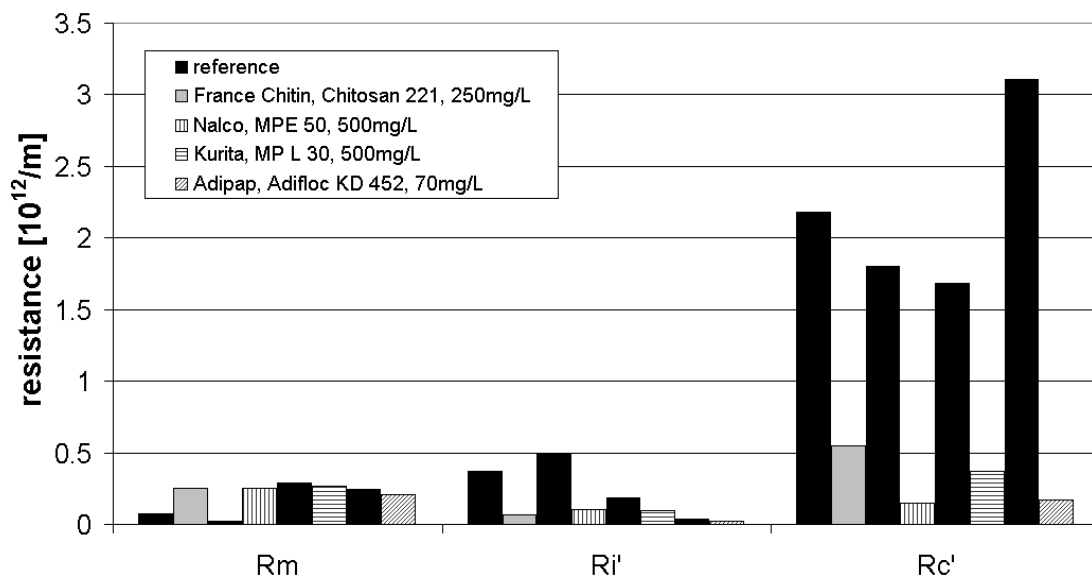

Figure 4. Resistance during filtration (R_m – membrane resistance, R_i' – resistance due to internal fouling, R_c' – resistance due to filter cake) (see also Iversen et al., 2007b)

Also, the so-called critical flux was evaluated for the reference mixed liquor and additive spiked mixed liquor (Koseoglu et al., 2008). It could be shown that all synthetic polymers (cationic) strongly increased the critical flux by around 40%. The addition of FeCl₃ and PACI both enhanced this value by 14%. For the natural polymer starch, an improvement of 22% was found while the addition of chitosan did not change the critical flux. This was astonishing as chitosan strongly reduced the SMP in supernatant and also showed the strongest effects on the mean particle size (as discussed in the next paragraph).

Particle size distribution (PSD, volume share): As relatively strong shear stress is applied in MBR – especially for the aeration of the biomass and the membrane module – but also due to pumps, stirrers, tubing, etc., the effect of shear stress on particle size distribution was evaluated (Iversen et al., 2008b). While the synthetic polymers and especially the chitosan increased the mean particle size by around 50 and 130%, respectively, the addition of starch, PAC and the metal salts did not change the PSD significantly. The improvements in the capillary suction time (CST) showed generally a similar trend: strong improvements when chitosan or synthetic polymers were added, less improvement when PAC SA Super, starch or FeCl₃ were added. No improvement at all was found if PACI Magnasol 5108 or the other PAC Picahydro LP 27 was added to the sludge. Also, the assumed effect of shearing on the PSD was not found.

Combination of additives: As the additives show different mechanisms in activated sludge, the question occurred if a combination of two additives (especially one flocculant with one adsorbant) would show added value. Therefore, combinations of two different additives (FeCl₃, PAC SA Super, synthetic polymer MPE 50) in different concentrations and combinations were tested. While the activated carbon was most efficient on SMP removal with up to 90% of protein concentration and 45% of polysaccharide concentration, the cationic polymer showed the strongest increase in dewaterability, in this case up to 40%. Therefore the combination of these two additives can be stated as the best to use (Villwock et al., 2009).

Pilot plant operation: Three additives were tested in the pilot system, the synthetic polymers MPE 50 and KD 452 and the starch Mylbond 168 (Iversen et al., 2009c). The optimum concentration was reached with a step at the beginning of the experiment. Additive loss by excess sludge withdrawal was accounted for by re-dosing of additive twice a week. The TMP evolution always showed the typical exponential characteristic with a slow increase in the first 20 to 40 days followed by a rapid steep increase as exemplarily shown in Figure 5. While the addition of a chemical did not change the initial TMP and the evolution during the first days, the exponential increase and its beginning were significantly altered.

When a cationic polymer (70 mg/L KD 452 or 500 mg/L MPE 50) was added to the activated sludge, a decrease of fouling was observed in comparison to the untreated reference. Especially when KD 452 was added to the sludge the time when the exponential increase started was significantly shifted (Figure 5). MPE 50 also showed quite good results in retarding the fouling. This can especially be seen in the last phase when the flux was increased by about 20 % and during the drive out period while there was still some flocculant in the plant. Here, the recovery after the chemical cleaning was much higher for the MPE 50 treated plant (72 % for the treated plant vs. 18 % for the reference). The fouling layer seems to be less persistent than in the reference plant (Iversen et al., 2009c). Previous filterability tests in test cell experiments showed a similar pattern (Koseoglu et al., 2008).

A totally different effect was found when 1.5-2 g/L of the starch Mylbond 168 was added to the sludge. Due to the very promising results in test cell trials, where the filterability and the critical flux were increased when this starch was added to the sludge, and to the fact that this chemical is a natural polymer, Mylbond 168 was selected for further trials in the pilot plant.

Nevertheless, the addition of Mylbond 168 to the sludge had detrimental effects on the membrane. Although the initial TMP was (like for the other trials) around 20 mbar in both plants, the TMP started to differ significantly after 30 days. During the high flux trials the pressure even increased to the limiting value of 200 mbar. This observation also fits with the results from the shaking flask tests where an increase in polysaccharide concentration and humic and low molecular weight substances was observed in the supernatant (Iversen et al., 2009c). The starch is not only bound to the sludge flocs but much starch residue remains dissolved and penetrates the membrane (significant amounts were found in the permeate) and can cause fouling on and inside the membrane. The contradicting results between the test cell trials and the results from pilot plant operation stress the importance to evaluate possible flux enhancers not only by short term experiments but also in long term and larger scale trials.

As expected from the lab tests, no negative impact of either of the additives on nutrient removal was observed. Also the addition of the chemical reagents did not cause a significant increase of the sludge production.

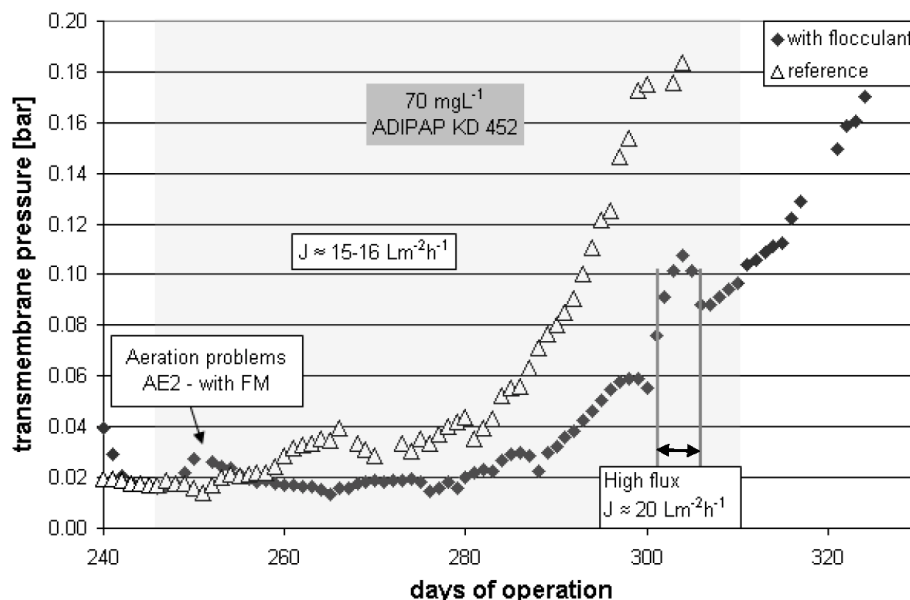

Figure 5. TMP evolution for reference plant and polymer (KD 452) added plant

Several characteristic values to describe the mixed liquor, such as SMP and EPS polysaccharides and proteins, biopolymers, CST, particle size distribution and MLSS were also evaluated. While all additives slightly increased the sludge flocs, the effects were not as pronounced as expected from the lab tests between the reference unit and the unit with flocculant. The addition of the synthetic polymer KD 452 reduced the biopolymers by 59%. All other parameters did not differ significantly between the two plants during the trials.

1.4 Conclusion

30 different chemicals were screened with regards to their potential for permeability enhancement and / or fouling control in MBR. Their impact on SMP removal, particle size distribution and fouling propensity of the sludge was considered, but also their biotoxic impact and optimum concentrations were studied. The most promising chemicals were investigated in long term trials in two identical MBR pilot units (1.6m³ and 22m² membrane module each) operated side by side and fed on real municipal sewage. While flocculants were dosed into one system, the other served as a reference. An overview of the results is given in Table 2.

Table 2. Selected additives and their positive (+) or negative (-) impact on investigated parameters soluble microbial products SMP, oxygen transfer coefficient $k_{L,a}$, oxygen uptake rate OUR, nitrification / denitrification, particle size (volume share), critical Flux J_{crit} and filtration performance in pilot plant

Substance	Supplier	Product	C_{Add} [mg/L]	SMP	$k_{L,a}$	OUR	Nitri/ Deni	Particle size V	J_{crit} test cell	Plant
Metal salt	Ciba	Magnasol 5108	100	+	-	+/-	--	+/-	+	
	Merck	FeCl3	85	+	+/-	+/-	+/-	+/-	+	
Chitosan	France Chitin	Chitosan 221	200	++	-	--	+/-	++	+/-	
	France Chitin	Chitosan 652	250	+	+/-	--	+/-	+		
Activated carbon	Norit	SA Super	450	+	+/-	+/-	+/-	+/-		
	Pica	Picahydro LP 27	5000	+	-	--	--	+/-		
Polymer	Nalco	MPE-50	500	++	+	+/-	+/-	+	++	+
	Kurita	MP H 30	500	+						
	Kurita	MP L 30	500	+	-	+/-	-	+/-	++	
	Adipap	Adifloc KD 451	70	+	+	+/-	-	+		
	Adipap	Adifloc KD 452	70	++	+/-	+/-	+/-	(+)	++	++
Starch	Rhodia	Jaguar C162	300	+	+/-	+/-	+/-	+/-		
	Tate & Lyle	Mylbond 168	1500	+	++	+/-	+/-	+/-	+	--

c_{Add} added concentration (= optimum concentration for SMP removal according to batch tests)
 ++ strong improvement
 + improvement
 +/- no effects
 - unwished effects
 -- strong unwished effects

For the three additives tested in the pilot systems the operation costs were in the range of 0.6 – 2.5 € per cubic meter of withdrawn excess sludge. Depending on SRT, the costs per m³ treated water thus vary significantly (Figure 6). For a typical SRT of about 20 d, 1-3 €cent per cubic meter treated wastewater would be incurred by the use of polymers, which would increase the operational costs by less than 10 % for larger MBR plants like Varsseveld or Nordkanal.

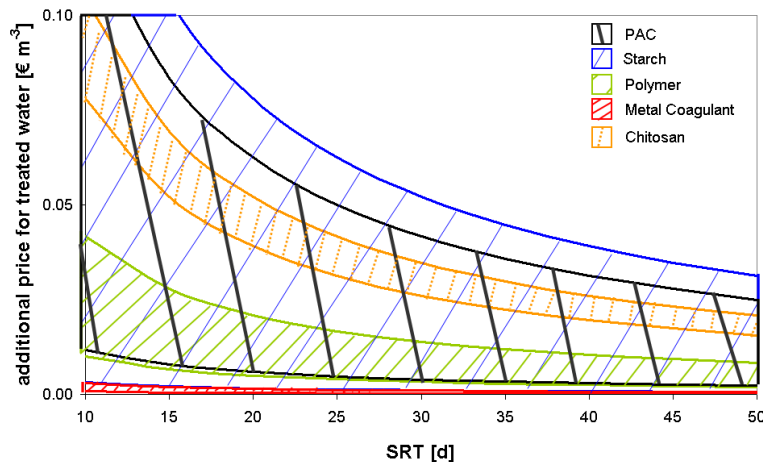

Figure 6. Operation cost of several flux enhancers depending on sludge age conditions.

2 Objective 2. Development of on-line sensors for fouling propensity of MBR sludge

2.1 Introduction

The development of reliable on-line sensors to monitor fouling substances or the fouling propensity of sludge, together with the identification of one or several additives to reduce the fouling propensity of the sludge (see Objective 1) would open avenues for dynamic fouling control and enhanced membrane filtration fluxes. Within AMEDEUS two on-line analysers were developed. One approach is based on a physical test (assessment of sludge filterability, VITO Fouling Measurement) and another approach is based on chemical analyses of the organic fouling substances in the sludge interstitial water after particle retention (Photometrical EPS SIA sensor).

2.2 MBR-VFM (VITO Fouling Measurement)

VITO aimed to develop a fouling measurement method and sensor which moreover evaluated both the reversible and irreversible fouling propensity of membrane bioreactor mixed liquor. A module (sensor) was designed which holds one tubular membrane (Figure 7. , A). The sensor can be placed directly in a MBR or within a separate tank, which is fed by a sampling device and (dis)continuously delivers a representative sample of the MBR mixed liquor. The MBR-VFM (VITO Fouling Measurement) measuring apparatus (Figure 7. , B) is a software controlled and fully automatic filtration device which extracts permeate from the sensor while storing all relevant filtration data. The control, data-acquisition by automatic sampling and MBR-VFM related standard calculations are performed within the proprietary software MeFiAS® which was developed at VITO under LabVIEW® and adapted towards the specific set-up.

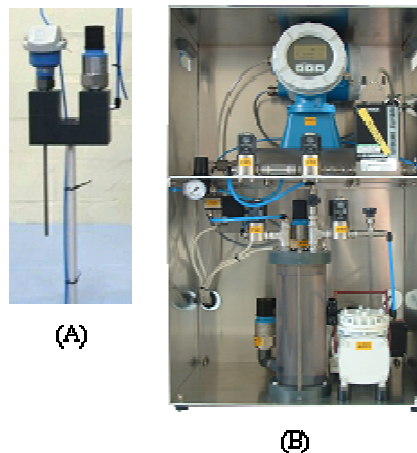

Figure 7. MBR-VFM set-up (A= sensor ; B= measuring device)

The MBR-VFM approach is based on the widely accepted resistances-in-series model of the membrane resistance and the total additional fouling resistance. An important aspect relates to the fact that the total additional fouling resistance in reality is to be considered as consisting of two completely different fouling components: the reversible fouling component and the irreversible fouling component. It was judged to be absolutely necessary to implement within the MBR-VFM measuring protocol the possibility to determine and distinguish both the reversible and irreversible fouling characteristics because then the most appropriate action (e.g. initiation of a chemical cleaning as opposed to increased aeration)

can be taken. Therefore a cyclical protocol was elaborated which envisages to measure the reversible part in a first cycle under low cross-flow mode resulting from a low slug aeration flow. The irreversible fouling is then measured in a high cross-flow mode in the next cycles (Figure 8). From the MBR-VFM measurement data, two MBR-VFM fouling graphs can be produced: the reversible and the irreversible one. Through image recognition by fuzzy set logic, this information can be translated into reversible and irreversible fouling numbers, ranging from 0 to 100%. More details on set-up, protocols and calculations, are described in Huyskens et al. (2008).

Within AMEDEUS, the MBR-VFM sensor was developed and the measurement protocol defined and optimized. In a first series of experiments, the reproducibility of the method was demonstrated. Then, the influence of the membrane material (PES versus PVDF) on reversible and irreversible fouling of mixed liquor was studied as well as the sensitivity for various parameters which are implied in MBR membrane fouling, such as MLSS, EPS concentration, etc. These were reported in Huyskens et al. (2008).

In a final step, the MBR-VFM was validated in different lab-scale MBR tests, where MBR-VFM measurements were performed and compared to on-line permeability data. By means of example, Figure 9 shows the results for one lab-scale MBR. It is clear that the increase in TMP measured on-line, corresponded with the higher reversible fouling propensity measured by the MBR-VFM. Interestingly, the fouling fingerprint had already started to decrease on day 22 while a clear TMP increase only became visible a few days later in the on-line TMP data. These results demonstrate that the MBR-VFM is a good indicator of fouling propensity and can even detect fouling earlier than can be seen from the on-line filtration data.

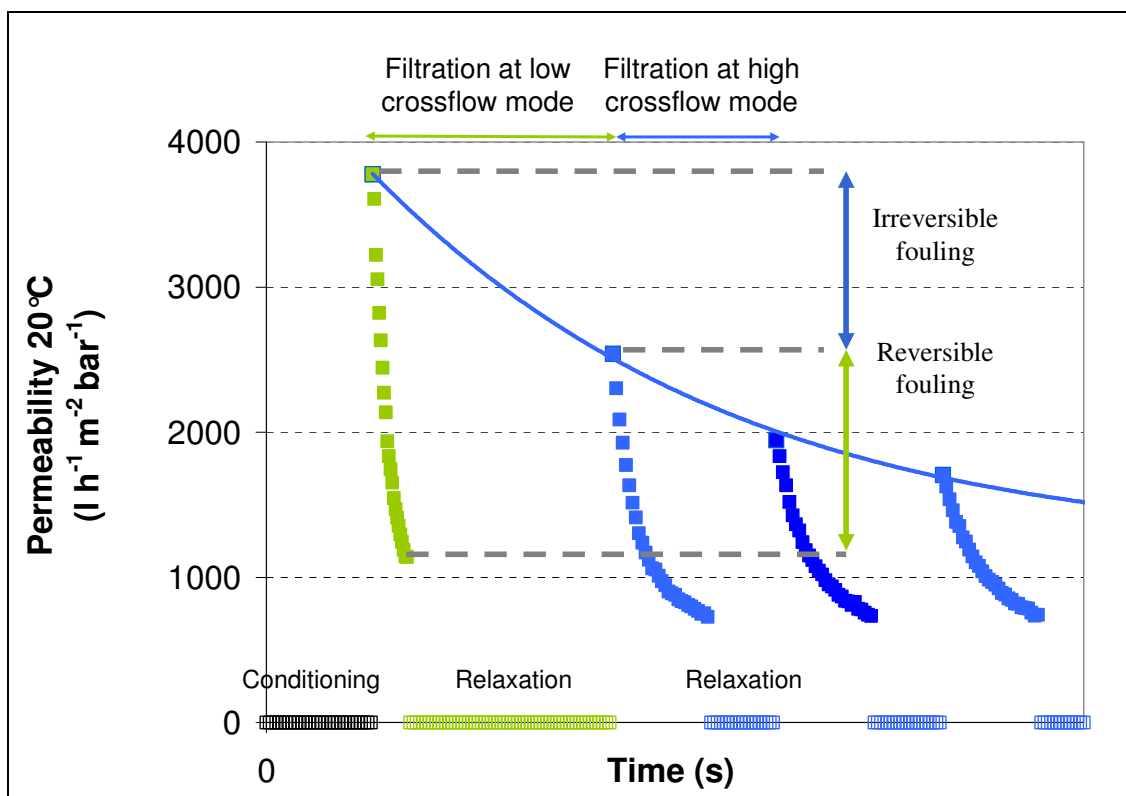

Figure 8. Schematic representation of MBR-VFM measurement protocol.

In conclusion, the investigations proved that the MBR-VFM method enables the (on-line) evaluation of the reversible and the irreversible fouling propensity of MBR mixed liquor in a reproducible way and that the measurement is sensitive to variations in parameters involved

in fouling. Validation in different laboratory-scale set-ups showed that the measurements corresponded with the actual fouling behavior of the MBR. The MBR-VFM thus has an important potential to characterize the fouling propensity of MBR mixed liquors.

The distinction between irreversible and reversible fouling components can be used in principle as input for an advanced control system (ACS) to optimize the mechanical membrane cleaning actions related to reversible fouling and the chemical membrane cleaning actions related to irreversible fouling (see also Objective 7).

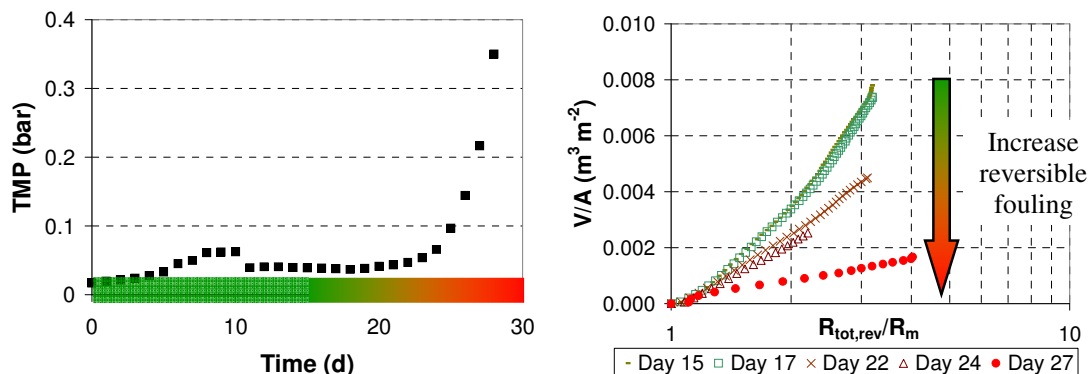

Figure 9. Evolution in on-line TMP measurement and reversible fouling fingerprints for a lab-scale MBR. V/A: m³ of permeate per m² of membrane, R_{tot,rev}/R_m: ratio of total reversible fouling resistance and membrane resistance.

2.3 Photometrical EPS-SIA-Sensor

The chemically based EPS fouling sensor conducts continuously automated measurement of the concentration of polysaccharides and proteins in mixed liquor. This approach is based on the presumption that polysaccharides and proteins that are main compounds of bacterial EPS (extracellular polymeric substances) cause the majority of membrane fouling in the MBR system (Rosenberger et al. 2006). The analytical determination of both, protein and polysaccharides rely on photometric assays that measure unspecifically carbohydrates or protein compounds. After method screening two analytical approaches were selected for the adaptation to the continuous sensor measurement: (i) the method of Dubois et al. (1956) for polysaccharides and (ii) the method of Lowry et al. (1951) for proteins. Corrections of interfering substances (NO₃⁻, NO₂⁻ for polysaccharides, humic substances for proteins) have not been applied for automated methods.

The automation of manual lab based photometric assays can be realised by the help of Flow Injection Analysis techniques (FIA) (Ruzicka & Hansen, 1988). However for the present objective, its advanced development, i.e. the Sequential Injection Analysis (SIA) technique, seemed to be more favourable for the set-up of the on-line sensor. SIA has already been successfully applied for on-line determination of various compounds in food and bioprocess monitoring, pharmaceutical and process analysis (Lenehan et al., 2002) due to its good precision in on-line applications and low chemical consumption.

The EPS sensor consists of two main components: a newly developed sample pre-treatment device (Mehrez et al., 2007a) and the sequential injection analyser (SIA) for on-line measurement of polysaccharides and proteins (Figure 10).

For the sample pre-treatment a stainless steel microfilter with a nominal pore size of 1 µm and surface of ~ 50 cm² is utilized. The filter is submerged in the activated sludge; the sludge is filtrated continuously (flux 10 - 17 Lm⁻²h⁻¹). In order to prevent filter clogging the filtration (10 min) is intermitted by a relaxation (2 min). Additionally sludge turbulence and air scouring

in the membrane reactor prolong the filtration time until cleaning of the filter is necessary (every 2-3 weeks with 1 % NaOCl and 10 % conc. H₂SO₄). The filter is reusable. The filtrated supernatant is pumped into the small sample vessel from which subsequently the SIA analyser aspirates the necessary sample volume for the analysis.

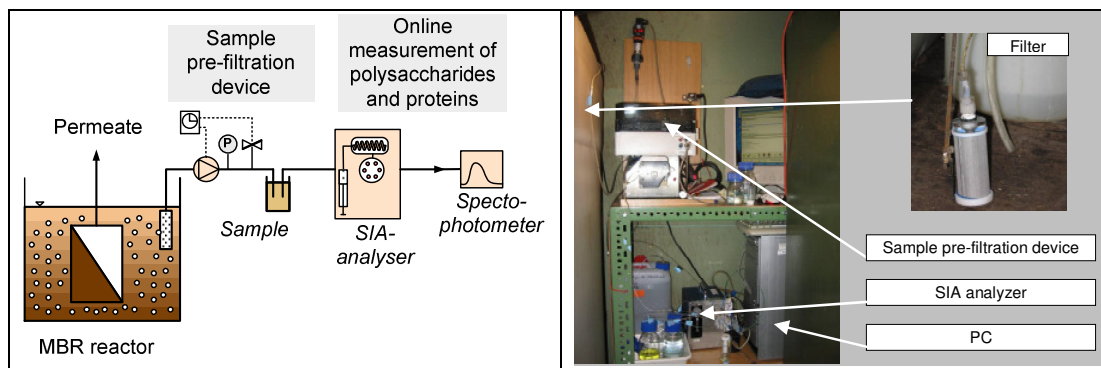

Figure 10. Scheme of EPS sensor system (left); EPS sensor installed in the MBR unit (right).

A testing program on the separation properties of the stainless steel filter developed for on-line sample preparation with regards to parameters like turbidity, DOC, concentration of polysaccharides and proteins was conducted and similar results compared with manual paper lab filtration could be obtained (Mehrez et al., 2007a). The stainless steel filter allows passage of polysaccharides and proteins but retains suspended solids and bacterial flocs in a very effective way. Important is that separation remains the same over time to guarantee representative sample pre-treatment during the whole filter run-time for subsequent measurement of proteins and polysaccharides (Mehrez et al., 2007a).

In the classical SIA approach the reaction between sample and reagents takes place in the tubes of the system. This procedure was adapted as after screening and optimisation tests a separated reaction chamber resulted in lower detection limit, higher accuracy and better reproducibility of results. The newly developed reaction chamber was made from analytical glass with a conic form and was covered by a PVDF cover fixing the inlet tubes. The sample and the reagents are pumped into the chamber; mixing is performed by introducing air and induced turbulence. The resulting coloured reaction products are transferred to the flow cell where absorption at a distinct wavelength is measured and the concentration is calculated.

Initial method development was performed in experiments with standard solutions. Different method parameters were tested and optimised (e.g. concentration and volume of reagents, volume and relation of sample and reagents, velocity of aspiration and dispensing of sample and reagents, carrier velocity during measurement, reaction time, carrier composition etc.). The most important factors for successful adaptation of the **polysaccharides** method with SIA were the use of the reaction chamber (i), the injection of reagents with a high flow rate (ii) and the application of degassed carrier solution (iii). The limit of detection (LOD) and of quantification (LOQ) were very similar or even lower in comparison to the manual procedure (0.9 and 3.4 mg/L for automated and to 1.2 and 4.2 mg/L for manual assay respectively). The measurement error was calculated through several repeatability tests to 0.5 mg/L that was smaller than for the manual assay (1 mg/L). (Mehrez et al. 2008)

For the determination of **proteins** concentration three different adapted approaches of the Lowry method were successfully developed and tested, improving step by step the sensitivity, LOD and measurement error: Method I (Mehrez et al., 2007b), Method II (Mehrez et al. 2008), Method II modified. Thereby the reagents and the reaction conditions changed slightly. In Method I the reaction (mixing of the sample and the reagents) takes place in the holding coil (tube) while the product solution flows through the SIA system. Method II and II

modified differ slightly in two ways: firstly the composition of one of the reagents was changed by addition of chelating agent (nitrilotriacetate) in order to prevent the formation of precipitates in sludge filtrate samples during the analysis, and secondly the external reaction chamber was applied. The improvement of the automated method for proteins compared with the manual method is shown in Table 3. The formation of precipitates disturbs the photometric measurement and has been observed only in real samples (mixed liquor, raw waste water, and influent). Good correlation of calcium ions concentration with the precipitate quantity as well as the fact that the chelating agent prevents effectively precipitate formation, support the hypothesis that the calcium ions are mainly responsible for the haze formation. More details on method modifications are described in the public deliverable report D12b.

Table 3. Sensitivity, detection (LOD) and quantification limit (LOQ), measurement error (ME) of different methods for protein determination.

	Automated Method with SIA			Manual method
	Method I	Method II	Mod. Method II	
Sensitivity (slope calib.)	6.8E-4 L/(mg·2 cm)	3.0E-3 L/(mg·2 cm)	3.6E-3 L/(mg·2 cm)	6.7E-3 L/(mg·1 cm)
LOD [mg/L]	10.5	3.9	1.3	1.0
LOQ [mg/L]	32.8	13.5	4.8	3.3
ME [mg/L]	2.8	2.3	0.9	0.3

The photometrical on-line EPS sensor was tested in the pilot MBR described above (see Figure 3) - in order to investigate the robustness of the developed SIA instrument and to monitor the impact of dynamic operation conditions on the evolution of the indicators of organic foulants (polysaccharides, proteins). The concentration of polysaccharides and proteins were measured in the filtrate of the sludge from the aerobic chamber. Polysaccharides and proteins were analysed subsequently in 1 to 3 weeks intervals as parallel measurement was not applicable with one SIA system. For monitoring of proteins concentration, Method II was applied, as the modified Method II with lower detection limit was developed in parallel in the laboratory with a second SIA system. Due to time constraints this more sensitive protein method could not be applied in the real MBR system.

Online measurements (every 3-4 hours) of polysaccharides and proteins in sludge filtrate were conducted under different conditions:

- Normal conditions
- Simulation of rain water events
- Simulation of influent peaks.

The continuous measurements on the MBR pilot plant revealed that there are no characteristic daily or weekly profiles of polysaccharides or proteins concentration. It seems that the concentrations vary due to long term events like seasonal temperature decrease, changing suspended solids concentration etc. E.g. during three weeks of monitoring time of polysaccharides, the decreasing polysaccharides concentration (from ~15.7 to 6.5 mg/L) correlated well with dropping suspended solid concentration in sludge (from 7.3 to 4.0 mg/L).

During the monitoring time with the EPS-sensor (from Aug. 2008 to April 2009) the polysaccharides concentration varied between 5 and 18 mg/L and the proteins concentration between 10 and 35 mg/L. The daily fluctuations of the polysaccharides concentration in September were rather moderate - on average the concentration varied about 0.8 mg/L per day (SD ±0.62). In autumn the daily fluctuation increased due to changing weather conditions (temperature decrease, storm water events) and was in mean 1.7 mg/L (SD ±1.01). The same observation was made during the monitoring of proteins concentration: in summer the mean daily variation was 1.2 mg/L (SD ±0.91) and in autumn the daily fluctuation increased to 4.9 mg/L (SD±4.0).

Surprisingly the dynamic experiments with addition of tap water (constant organic load to simulate rain water events) to the influent of the MBR pilot did not provoke significant variations of polysaccharides (Figure 12) or proteins concentration (Figure 11). However the inflow loading peaks (Figure 12) provoked sudden rise of the polysaccharides concentration of about 35 % (average increase of 4.8 mg/L). That can be explained by the reduction of HRT combined with higher organic load during inflow peaks that was probably not enough for the biodegradation of bigger molecules in the influent like polysaccharides. In contrast, the monitoring of proteins concentration during the simulation of inflow load peaks has not revealed any significant fluctuations or increase in addition to the normal daily fluctuations. Apparently the additional proteins introduced with the influent penetrated the membrane or were biodegraded and did not accumulate in the sludge.

The continuous measurements could not verify the positive correlation of measured parameters versus TMP increase neither for proteins nor for polysaccharides that was previously observed by Rosenberger et al. (2006). In contrast, for the two first analysis periods, the polysaccharides concentration decreased when the TMP increased. During the on-line analysis of proteins no or only a slight increase of TMP was observed when the proteins amount in sludge filtrate remained quite stable.

The automated method used for continuous measurement of proteins at the pilot plant (Method II) is suitable for monitoring of trends especially at high proteins concentration. In order to decrease the measurement error, the calculation of an average value of 8 h results is proposed to assure the reliability of measured concentrations. In parallel, manual measurements of polysaccharides and proteins were conducted and showed very good agreement with continuous measurements (Figure 12).

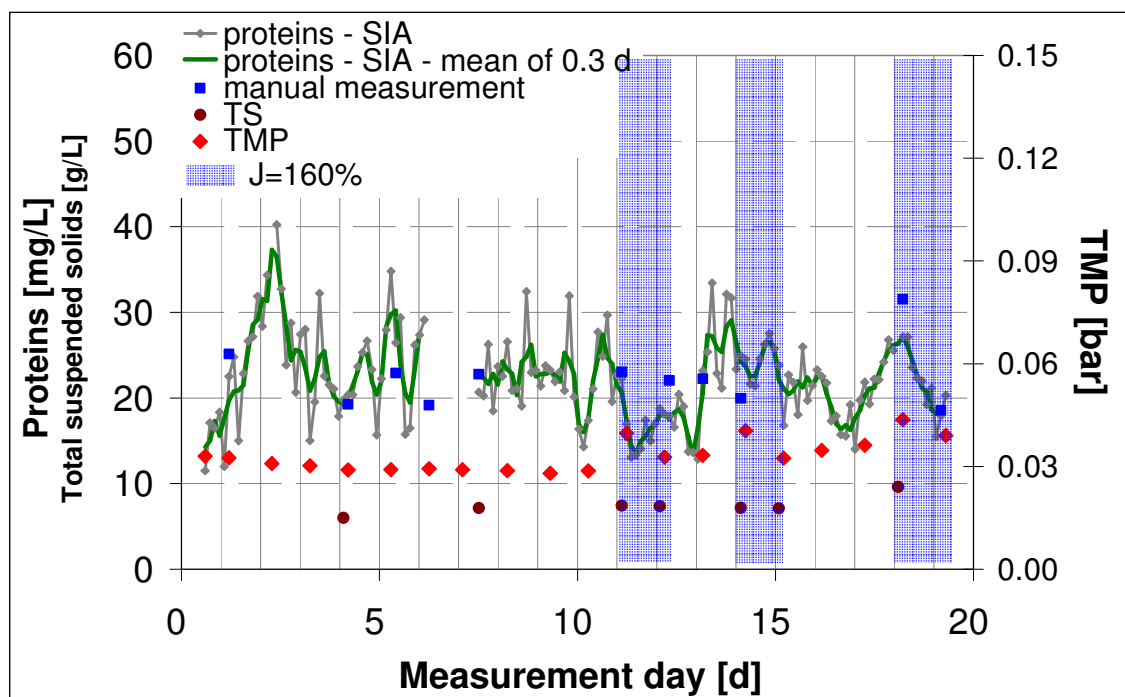

Figure 11. Variation of PR concentration in sludge filtrate of MBR measured continuously during simulation of rain water events (from 13th Nov. to 2nd Dec. 2008).

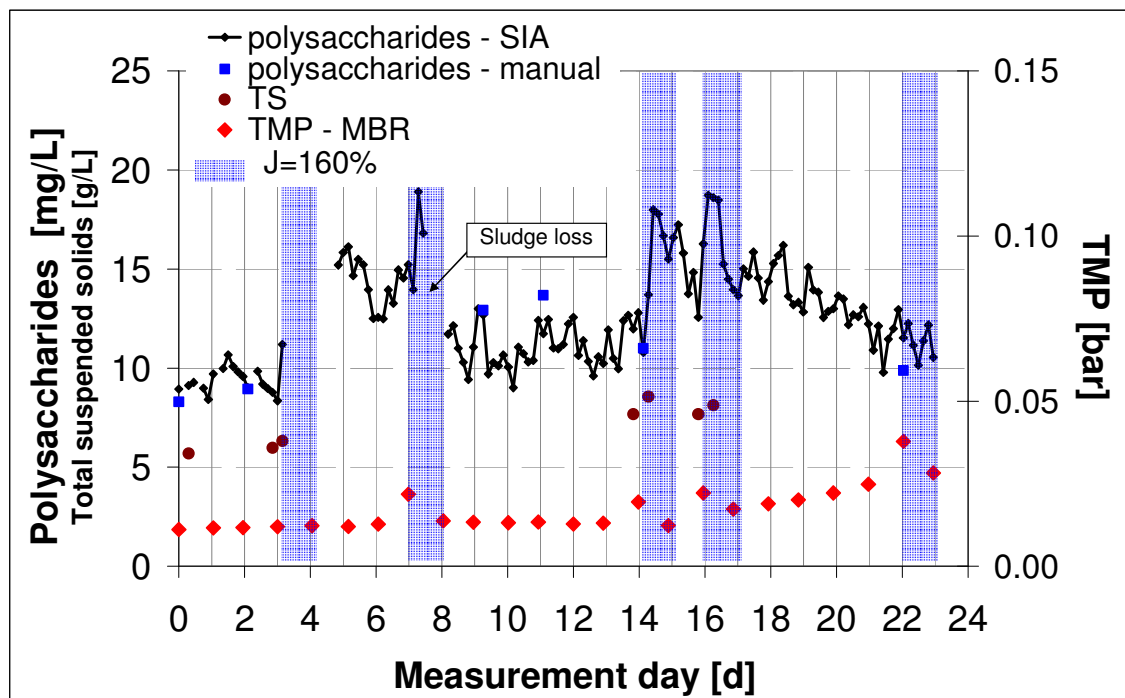

Figure 12. Variation of PS concentration in sludge filtrate of MBR measured continuously during simulation of inflow peaks (from 23rd March to 15th April 2009).

With the new EPS SIA sensor a sensitive, robust and reliable analyser is now available to collect comprehensive sets of data on polysaccharides and proteins concentration in MBR sludge filtrate and allowing the monitoring of daily and seasonal variations of these parameters as well as evaluation of their impact on membrane fouling and flux decrease in the MBR reactor.

The results from monitoring of the concentration of polysaccharides and proteins with the EPS sensor showed quite high fluctuation during the week and sometimes even within one day. This demonstrates that manual sampling and analysis of considered parameters may not give an appropriate image of the variation of fouling compounds in the mixed liquor even if a correlation between TMP and EPS compounds could not be verified.

An important aspect of the development of the photometrical sensor is the contribution to the standardisation of the determination techniques for proteins and polysaccharides. Up to now the determination protocols are carried out by different analytical methods or protocols having the consequences of being hardly comparable. After the present method development, the physical establishment of the SIA sensor is not really expensive. Some companies and operators already showed an interest in purchasing the EPS SIA analyzer developed within the AMEDEUS project.

More details on the development and investigation of the online photometrical sensor can be found in the public deliverable report D12b.

2.4 Comparison of MBR-VFM and EPS-SIA sensors

In Table 4, a comparison between the MBR-VFM and EPS-SIA sensors is made and measurement principles as well as pros and cons are summarised. Due to the strong complementarities of both approaches, their simultaneous implementation as inputs for an advanced control system could be highly interesting (see Section 7).

Table 4. Comparison of MBR-VFM and EPS-SIA sensors

	MBR-VFM sensor	EPS-SIA sensor
Measurement principle	Physical filtration of mixed liquor	Chemical (photometrical) analysis of foulants in sludge filtrate
Evaluation of fouling potential	Determination of reversible and irreversible fouling characteristic	Determination of the concentration of polysaccharides and proteins as potential fouling causing substances
Measurement mode	Automated according to optimized protocol Membrane mounting and cleaning manual until now	Fully automatic Calculation of concentrations manually until now
Pre-treatment of the sludge sample	Filtration at 1 mm	Filtration with microsieve filter (stainless steel, 1 µm) in order to remove the solids
Measurement time / frequency	1h if only reversible fouling number is needed, otherwise 2-3 h	< 1.5 h per measurement incl. duplicates measurement every 2-3 hours sufficient (Ernst et al. 2007)
Possible application	Optimisation of both mechanical (relaxation, backwash, etc.) and chemical cleaning actions, based on reversible and irreversible fouling number respectively	Optimisation of operation (e.g. HRT), addition of specific fouling reducers to counteract high foulant concentrations
Pros	<ul style="list-style-type: none"> • Direct method for determination of fouling propensity • Takes into account all contributing foulants, e.g. MLSS, sludge composition, all EPS fractions, fluctuating wastewater composition, ... • Differentiation between reversible and irreversible fouling • Possibility to adjust filtration parameters related to mechanical or chemical cleaning to the measured reversible and irreversible fouling potential respectively 	<ul style="list-style-type: none"> • Fully automatic measurement on-site • Monitoring of daily and seasonal variations of fouling substances (polysaccharides, proteins) • Quick identification of changes of the sludge properties • Modular in application: measurement can be extended on other substances measurable with photometric methods • Reusable filter for sample pre-filtration • Standardisation of the determination techniques for proteins and polysaccharides
Cons	<ul style="list-style-type: none"> • Hydrodynamic conditions in the testing membrane and membrane material of sensor should be identical to those of the real operational membranes of the MBR • Execution of consecutive measurements is not automated yet, but automation is possible 	<ul style="list-style-type: none"> • The verification of the direct relation of fouling vs. polysaccharides / proteins is still debated. Potential risk not to measure all causes of fouling. • Calculation of concentrations manually (further development possible) • Parallel measurement of polysaccharides and proteins only possible with two SIA devices

3 Objective 3. Improving membrane cleaning

3.1 Introduction

It is recognised that MBR cleaning procedures have to be further improved in relation to full-scale integration, protocol and chemicals. Each technology developed by the 3 producers of MBR system in the AMEDEUS project (see Objective 10) was thoroughly examined in terms of membrane fouling, and the cleaning procedure was optimised, first on small membrane samples before validation at pilot scale. In particular, innovative membrane regeneration solutions and alternative to chlorine-based cleaning were investigated, such as hydrogen peroxide based solutions or enzymatic formulations as the use of chlorine is not well accepted in some countries like Germany. Optimised cleaning protocols were identified for each technology, with reliable alternative to chlorine-based cleaning.

3.2 Materials & Methods

Several protocols and tools for membrane cleaning were developed at Anjou Recherche to foul and clean membranes delivered by:

- A3 Water Solutions (MF flat sheet membrane made in PVDF);
- Polymem (UF hollow fibres membrane made in PSU);
- Inge (MF FiSh (Fibre Sheet) membrane made in PES).

In this study, several cleaning tests were performed: 1) lab scale tests on flat sheet new membrane fouled with sludge supernatant; 2) lab scale tests on membrane samples fouled in a MBR pilot plant (when it was possible to perform mini-modules from the industrial modules); and 3) intensive cleanings of the module operated in the MBR pilot plant (see Objective 10). This study on cleaning is backed up by a full diagnosis of membrane fouling: the membrane was fully characterized before and after usage, with the intention to define the type of deposit accumulated on the membrane (organic and mineral elements).

3.2.1 Cleaning experiments

Water permeability measurements at lab-scale. A laboratory filtration unit, specifically adapted for each technology, was built. Two pressure sensors were installed; one at the feed inlet and one at the recycled feed outlet and the permeate flow rate was measured with a scale. For the permeability measurements on flat sheet membranes, deionised water was pumped into the filtration cell in which one flat sheet membrane with an active surface of 110 cm² was installed as shown in Figure 13. The pump was chosen to obtain a continuous and stable flow. For the permeability measurements on hollow fibres and on FiSh membranes, deionised water was pushed into the adapted filtration cell using a pressurised vessel (Figure 14). Hollow fibre mini-modules of 225 cm² and FiSh plates of 378 cm² were used. The permeability of three hollow fibre modules could be measured at the same time.

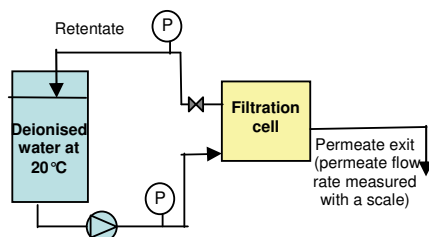

Figure 13. Design of the pilot to measure the permeability of flat sheet membranes at lab-scale

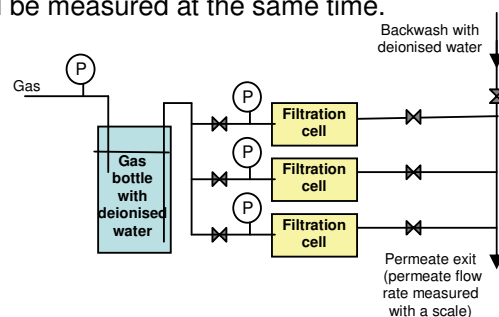

Figure 14. Design of the pilot to measure the permeability of hollow fibre modules and FiSh sheets at lab-scale

Before permeability measurements were taken, the lab-scale unit and the membrane samples were rinsed with a chlorine solution (20 – 100 ppm) and the integrity of the hollow fibres and FiSh mini-module was checked at 0.2-0.3 bar. The initial permeability of membrane samples with deionised water was then measured by regression at different pressures from 0.2 bar to 1 bar.

Fouling and cleaning experiments performed at lab scale. Anjou Recherche developed a lab scale protocol to foul new membrane pieces with sludge supernatant. Fresh sludge taken from an MBR pilot plant (Figure 42) was pre-screened at 50 μm and then at 25 μm . The total and soluble COD of the screened supernatant were measured in order to check the quality of the supernatant. Two to three membrane samples were then fouled in lab-scale units shown in Figure 15 for flat sheet membranes, and shown in Figure 16 for hollow fibres and FiSh mini-modules. Similar filtration cells to those used for the permeability measurements with deionised water were used. In each case, the feed water was pumped into the filtration cell in which membrane samples were installed. Retentate and permeate were recycled in the storage tank as shown in Figure 15 and Figure 16. The cross flow rate at the membrane surface remains low between 1×10^{-1} and 5×10^{-4} m/s. Permeate flow rate was measured with a scale. Values of pressure at the feed inlet, at the recycled feed outlet and permeate flow rate were stored in a computer.

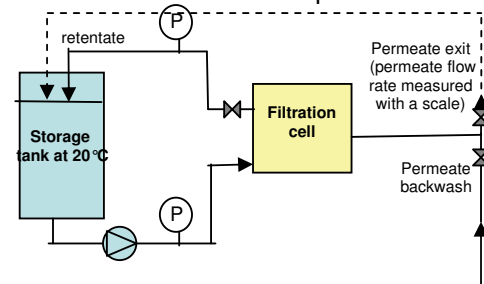

Figure 15. Pilot diagram to foul two flat sheet membranes with sludge supernatant

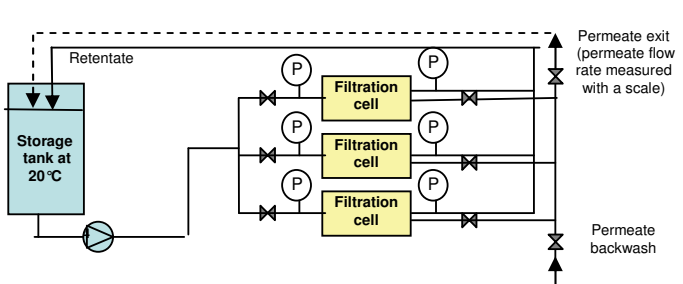

Figure 16. Pilot diagram to foul three hollow fibres bundles or FiSh modules with sludge supernatant

The protocol to obtain internal fouling on the membrane with a permeability drop of 75% was established in a reasonable time of 24h. Experiments with continuous filtration and with filtration/relaxation modes (50 minutes/10minutes) were also performed. At the end of the fouling period, the samples were rinsed with de-ionised water to remove any cake deposit before measuring the permeability with deionised water. Hollow fibres were also previously subjected to a 5 minutes backwash with deionised water to remove any residual particles.

Cleaning tests were first performed by soaking the membrane at room temperature during 2h. Other cleaning protocols (longer soaking, with filtration and backwash steps) were then tested on the Polymem hollow fibres and on the inge FiSh membranes following the first cleaning results to improve the effectiveness of some cleaning reagents.

Fouling performed at full scale and cleaning experiments at lab scale. Membrane samples operating in the pilot-plant under typical biological operating conditions (MLSS = 11 g/l, SRT = 28 days, F/M ratio = 0.11 kgCOD/kgMLSS.d) were taken to verify the effectiveness of the cleaning products tested on membrane fouled with sludge supernatant. The same protocols for the cleaning and the permeability measurements as for the membrane fouled with sludge supernatant were used. For the A3 membrane, membrane samples coming from two plates fouled in the pilot-plant during 5 months were used for these cleaning tests. For the Polymem membrane, hollow fibres were cut in bundles coming from the industrial module. For the inge membrane, it was not possible to perform mini-modules from the industrial modules, and therefore this step was not performed.

Tests at full scale. Intensive cleanings were finally performed during the pilot trials on the industrial modules operating in a MBR pilot-plant (used for Objective 10): reference tests with a standard chlorine solution and other cleanings with reagents selected from the study at lab-scale were carried out.

Cleaning reagents. Several cleaning reagents, listed in Table 5, classified into four classes of reagents were considered: sodium hypochlorine as reference, other oxidizing reagents, enzyme products and chemical acids. Some were not tested on all the membranes as they were identified later. The cleaning reagents to be tested satisfied the different membranes tolerance (pH, T, maximal concentration).

Table 5. Cleaning reagents investigated in the study

Nature	Reagent	Formula/ Notation	Concentration	Membrane tested
Reference	Sodium hypochlorine	NaOCl	200 ppm and 1900 ppm Cl-	A3, Polymem, Inge
Reference	Sodium hypochlorine + caustic soda	NaOCl + NaOH	200 ppm Cl- adjusted at pH 13	Polymem, Inge
Oxidizing agent	Caustic soda	NaOH	pH 11 for A3 (~1.3 g/l); pH 13 for Polymem and Inge (4g/L)	A3, Polymem, Inge
Oxidizing agent	Hydrogen Peroxide (50%)	H ₂ O ₂	0.5 % (w/w) H ₂ O ₂	A3
Oxidizing agent	Hydrogen Peroxide (50%) + Caustic soda	H ₂ O ₂ + NaOH	0.5 % (w/w) H ₂ O ₂ adjusted at pH11	A3, Polymem, Inge
Oxidizing agent	A3 Activor A 101 (KOH, NaOH, NTA-Na-Salts)	A101	1% (w/w)	A3
Enzymes	Ultrasil 67 +Ultrasil 69 new (ECOLAB)	U67 /U69	0.5 % (w/v) and 1 % (w/v)	A3, Polymem, Inge
Enzymes	Filzym p (REALCO)	Filzym p	1% and 2% (w/w)	A3, Polymem
Enzymes	Enzybras multi (REALCO)	Enzybras multi	1% (w/w)	Inge
Enzymes	A3 enzymes product	SERL	1% and 4% (w/w)	A3
Acid	Hydrochloric acid	HCl	pH2 (~ 0.056 % (w/w))	A3, Polymem, Inge
Acid	Citric acid	C ₆ H ₈ O ₂ , 1H ₂ O	1 % (w/w)	A3, Polymem, Inge
Acid	Oxalic acid		1% (w/w)	Inge
Acid	A3 activor A 103 (HNO ₃ , H ₃ PO ₄ ...)	A 103	1% (w/w)	A3

Results interpretation. The results were interpreted first from the de-ionised water permeability values of the new, fouled and cleaned samples. The percentage of recovered permeability after cleaning was also used to compare the chemicals effectiveness:

$$R = \frac{Lp_{aftercleaning}}{Lp_{new}} .100$$

Lp_{new}: Permeability of the new membrane (L.h⁻¹.m⁻².bar⁻¹, 20 °C)

Lp_{after cleaning}= Permeability after cleaning (L.h⁻¹.m⁻².bar⁻¹, 20 °C)

3.2.2 Autopsy

To characterise the compounds accumulated at the membrane surface (membrane fouled in MBR pilot-plant) composing the internal fouling of the membrane, an extraction of the compounds attached on the selected membrane samples of the modules, previously rinsed with water, was performed. The extraction consisted in soaking the membrane samples in a known volume of deionised water during one night and then in subjecting them to a sonification. This method enabled a good extraction of the fouling agents from the membrane surface. The following analyses were then carried out on the deposit and on virgin membrane samples:

- Measurement of total (TOC) and dissolved organic carbon (DOC) in the deposit to evaluate the organic part of the deposit. The dissolved organic carbon's concentration is measured after filtration at 0.45µm (microfibre filters, Whatman);
- Characterisation of the dissolved organic matter of the deposit (previously filtered at 0.45µm with microfibre filters (Whatman)) by Size Exclusion Chromatography (SEC) with UV, nitrogen and organic carbon detection supplied by DOC Labor (Germany) (Huber and Frimmel, 1991);
- Measurement of mineral elements in the deposits (previously filtered with 0.45 µm microfibre filters (Whatman) by Inducted Coupled Plasma (ICP) for a semi-quantitative screening;
- Scanning Electronic Microscopy (SEM) of the membrane samples to determine the deposit's morphology and EDAX for elementary composition of specific particles on the membrane.

3.3 Results & Discussion

3.3.1 A3 membrane

Internal fouling composition. The DOC remained below 2µg/cm² for the analysed A3 membrane samples. A similar composition of the dissolved organic (DOC) fraction retained on the A3 membrane was observed for the different samples coming from the top module proving that the fouling was relatively homogeneous in the module. A large number of hydrophobic compounds not identified by chromatography (HOC), as well as humic substances and building blocks (SH+BB) were detected. Some biopolymers (P) (rather polysaccharides and amino-sugars) were also detected. The concentration of the different minerals in the deposit remained low (<2 µg/cm²) and consisted of: calcium, sodium, phosphorus, potassium, sulphur, magnesium and silica. To remove this internal fouling, chemical cleaning was required.

Fouling and cleaning experiments performed at lab scale. A dozen cleaning reagents were first tested on sludge supernatant fouled membrane samples from A3 Water Solutions. The soluble COD concentration differences (from 35 to 65 mg/L) observed in the sludge supernatant for the different tests were considered as normal.

The new membrane average permeability measured with de-ionised water was around 3700 L.h⁻¹.m⁻².bar⁻¹, 20°C (variation of 33.5%) and after fouling with the supernatant of 1170 L.h⁻¹.m⁻².bar⁻¹, 20°C (variation of 17%). For the A3 membrane, the cleaning was only performed by soaking membrane samples in the cleaning solution at room temperature for 2h. With regard to the cleaning reagent effectiveness, results showed that acid cleaning was not efficient. Cleaning with detergents (hydrogen peroxide with caustic soda) and enzymes reagents (Ultrasil and Filzym p products) gave better results (Table 6).

Fouling performed at full scale and cleaning experiments at lab scale. To verify the effectiveness of these products, flat sheet membrane plates operated in the MBR pilot plant over several months were removed. After removing the cake deposit with a tap water jet, membrane samples were cut. Samples with similar permeability were selected to perform cleaning tests. After fouling, the average permeability was 1240 L.h⁻¹.m⁻².bar⁻¹, 20°C (variation of 35%). Hydrogen peroxide and chlorine solution at 2000 ppm allow the best cleaning effectiveness, followed by chlorine solution at 200 ppm and Filzym p at 2%/w/w. Cleaning with Ultrasil reagent was not efficient.

Tests at full scale. Two intensive cleanings by soaking were performed during the pilot runs with the same A3 membrane: one with chlorine at 1000 ppm during 4h at 17°C and one with hydrogen peroxide at 0.5%/w/w during 2 h at 23°C, following the conclusions of the lab scale tests performed with membranes fouled in the full scale pilot unit. The first intensive cleaning

was done during 4h instead of 2h because the temperature was relatively low. The intensive cleaning with hydrogen peroxide at 0.5%w/w appeared less efficient than the one with chlorine at 1000ppm.

Table 6. Cleaning tests with the A3 membrane (2h soaking)

	Fouling and cleaning at lab-scale	Fouling at full-scale and cleaning at lab-scale	Fouling and cleaning at full scale
<i>Cleaning products enabling a total permeability recovery (R ~100%)</i>	Cl- 2000 ppm	Cl- 2000 ppm; H ₂ O ₂ (0.5%)+ NaOH	
<i>Cleaning products enabling a partial permeability recovery (R >80%)</i>	Cl- 200 ppm; H ₂ O ₂ (0.5%)+ NaOH; Ultrasil U67/U69; Filzym p 2%		Cl- 2000 ppm
<i>Cleaning products having a low efficiency (R >60%)</i>	NaOH; Filzym p 1%		
<i>Cleaning products having a very low efficiency (R >40%)</i>	SERL; hydrochloric acid	Cl- 200 ppm Filzym p 2%	H ₂ O ₂ (0.5%)+ NaOH
<i>Cleaning products not efficient (R<40%)</i>	A101; A103; citric acid	Ultrasil U67/U69	

Cleaning effectiveness differences were noticed between the different tests (with membranes fouled with sludge supernatant and in MBR pilot plant) which can be explained by a different fouling nature on the membrane and in particular, by the presence of an additional thin cake layer at the membrane surface in the MBR pilot plant fouled membrane. So, the internal fouling was less accessible. Therefore, the chlorine solution at a 2000 ppm concentration was more efficient than the one at 200 ppm with membranes fouled at pilot-scale, while no significant difference of effectiveness was observed for sludge supernatant fouled membrane experiment. This showed that full scale tests remain essential to validate the efficiency of chemical reagents.

3.3.2 Polymem membrane

Internal fouling composition. Several bundles were autopsied. Results highlighted differences in the composition of the organic matter and in minerals accumulated on various bundles probably because of the different fouling behaviour following the bundle location. However, neutrals or humic substances with building blocks were the major part of the dissolved organic fraction retained onto the membrane surface. Some important concentrations of calcium (> 10 µg/cm²) were found on one of the bundles and unusual mineral elements (Barium, Aluminium, Copper, Manganese, Strontium and Zinc) were detected at the membrane surface coming probably from the wastewater. Cleaning tests were carried out to identify efficient cleaning products to remove the internal fouling.

Fouling and cleaning experiments performed at lab scale. Around ten cleaning reagents were first tested on sludge supernatant fouled membrane samples from Polymem. To obtain a sufficient internal fouling with this membrane on 24h, sludge supernatant was filtered intermittently (50 min filtration/ 10 min relaxation). The soluble COD concentration variation for each test remained between 25 and 35 mg/l which was lower than for the A3 membrane. The average permeability of the new membrane was around 790 L.h⁻¹.m⁻².bar⁻¹, 20°C (variation of 11.5%) and of 210 L/(h.m².bar), 20°C (55%) after fouling. When looking at the cleaning results, it appears that chlorine at 1600 ppm and Ultrasil were the most efficient products (Table 7) followed by chlorine at 145 ppm, filzym p at 1% and hydrogen peroxide at 0.5% with caustic soda. The cleaning with the oxalic and citric acid seems also useful (more than on the A3 membrane) which can be linked to the deposition of some mineral elements like calcium as revealed by the autopsy of Polymem bundles fouled in the pilot-plant.

Fouling performed at full scale and cleaning experiments at lab scale. To verify the effectiveness of these products, bundles from the industrial modules which operated in the MBR pilot plant were removed. After removing the cake deposit with a tap water jet, hollow fibres were cut to form mini-modules. Samples with similar permeability were selected to perform cleaning tests. The results are summarized in Table 7.

After fouling, an average permeability of $125 \text{ L.h}^{-1}.\text{m}^{-2}.\text{bar}^{-1}$ at 20°C (variation of 40%) was measured which is lower than on the membrane fouled with sludge supernatant ($210 \text{ L.h}^{-1}.\text{m}^{-2}.\text{bar}^{-1}$ at 20°C). Some bundles were less fouled than others, which could be explained by the location of the diverse bundles and fibres into the bundles. In a same bundle, the fouling could vary because the bundles were partly clogged and the fibres in the middle had probably not the same internal fouling as they could less filtrate than the external fibres of the bundles. However, bundles with the most similar permeability were selected for the experiments.

The cleaning tests did not allow a complete recovery of the membrane permeability, as a consequence of a stronger internal fouling. However, Ultrasil product appeared to be the best cleaning reagent (Table 7) followed by high chlorine concentration solution (around 2000 ppm). Chlorine at 200 ppm with caustic soda and hydrogen peroxide at 0.5% with caustic soda enabled only a low recovery of the permeability. Filzym p was, on the contrary, not adapted to clean this membrane. Citric acid enabled also some permeability recovery. As for the A3 membrane, the efficient products on the membrane fouled with sludge supernatant did not appear to be always efficient on the membrane fouled at pilot-scale probably because of stronger fouling. Complementary tests were performed to improve the cleaning efficiency (longer soaking, filtration step to improve the reagent diffusivity), but it was not possible to totally recover the permeability. The Polymem membrane fouled at pilot-scale appeared to be difficult to clean.

Tests at full scale. Two intensive cleanings by soaking were performed at the end of the pilot trials with the Polymem final module (15 bundles of fibres with a packing density of 48%). The first intensive cleaning was performed with Ultrasil reagent for 2h and the second one with chlorine at 2000 ppm for 2h two days later. The Ultrasil reagent was chosen because it gave similar or even better results than the chlorine solution at 2000 ppm following the first tests. Both intensive cleanings did not permit to clean efficiently the membrane: a low permeability recovery was obtained (from 30 to $45 \text{ L.h}^{-1}.\text{m}^{-2}.\text{bar}^{-1}$). This result can be due to the important clogging in the bundles of the industrial module limiting the cleaning effectiveness. Therefore, the presence of sludge into the bundles at full-scale is detrimental for the cleaning effectiveness: it prevents the contact between the reagent and the internal fouling. The cleaning protocol would probably need here to be adapted.

Table 7. Cleaning tests with the Polymem membrane (2h soaking)

	Fouling and cleaning at lab-scale	Fouling at full-scale and cleaning at lab-scale	Fouling and cleaning at full scale
Cleaning products enabling a total permeability recovery ($R \sim 100\%$)	Cl- 2000 ppm; Ultrasil U67/U69		
Cleaning products enabling a partial permeability recovery ($R > 80\%$)	Cl- 200 ppm + NaOH		
Cleaning products having a low efficiency ($R > 60\%$)	H_2O_2 + NaOH; Filzym p; Cl- 200 ppm	Ultrasil U67/U69	
Cleaning products having a very low efficiency ($R > 40\%$)	NaOH; Oxalic acid; Citric acid	Cl- 2000 ppm; H_2O_2 + NaOH	
Cleaning products not efficient ($R < 40\%$)		Cl- 200ppm; Cl- 200ppm+ NaOH; NaOH; Filzym p; Citric acid ; Oxalic acid	Ultrasil U67/U69 Cl- 2000 ppm

3.3.3 Inge membrane

Internal fouling composition. High TOC values ($>200\mu\text{g}/\text{cm}^2$) were detected on the fouled inge membrane caused by the presence of residual sludge on the membrane in the membrane irregularities. The dissolved organic carbon part remains under $2\mu\text{g}/\text{cm}^2$ for the membranes and consisted mainly of biopolymers. Few humic substances and building blocks were detected. For the mineral part of the deposit, high concentrations of Calcium and of Phosphorus ($>10\mu\text{g}/\text{cm}^2$) were detected. Unusual mineral elements like Aluminium, Barium, Copper, Manganese, Strontium and Zinc were found in the deposit of the fouled membrane as for the Polymem membrane, coming probably from the wastewater. A regular acid cleaning could be required to avoid the accumulation of these compounds on the membrane surface because the cleaning with chlorine and oxidizing agents do not allow removing totally these compounds. To identify cleaning reagents and protocols to remove this internal fouling, several cleaning tests were considered at lab-scale.

Fouling and cleaning experiments performed at lab scale. The chosen cleaning reagents were first tested on membrane samples fouled with sludge supernatant. The average permeability of the new membrane was around $2970\text{ L}/\text{h}\cdot\text{m}^2\cdot\text{bar}$ at 20°C (variation of 27%) and of $364\text{ L}/\text{h}\cdot\text{m}^2\cdot\text{bar}$ at 20°C (variation of 72%) after fouling with sludge supernatant: some mini-modules were more fouled than others because of the variation of the sludge supernatant quality and membrane samples characteristics (irregularities at the membrane surface).

10 different cleaning products were selected and 3 successive protocols were tested.

Cleaning sequence n°1. The first cleaning protocol consisted of cleaning the membrane with the following sequence: 2x (15 min filtration – 45 min soaking). Compared with the previous tests with the A3 and Polymem membranes, a filtration step was added to improve the cleaning solution diffusivity into the fibres. Indeed, the first results with chlorine showed that the cleaning was more efficient by adding a filtration step. With this cleaning sequence, the most effective cleaning product was chlorine (alone or with caustic soda) followed by hydrogen peroxide and then caustic soda. The citric and oxalic acids were as efficient as caustic soda. On the contrary, the Genesys products (Mem X, Genosol 703, Mem 3) and the commercial enzymes products enabled only a low recovery of the permeability.

Cleaning sequence n°2. To see if some products (in particular, the alternative oxidizing agents and the enzymes products) could be efficient with a longer soaking, the previous cleaned membrane samples were soaked in the cleaning solution for 24h. Results clearly showed that hydrogen peroxide and caustic soda gave satisfying results as they permit to recover more than 80% of the initial permeability. The other cleaning products (Genesys, enzymatic products) were not very effective maybe because these products are not adapted to this kind of fouling.

Cleaning sequence n°3. To improve further the cleaning effectiveness, a third cleaning protocol was tested with chlorine, hydrogen peroxide and caustic soda consisting of replacing the filtration step by a backwash step: 2x (15 min filtration – 45 min soaking). Once again, chlorine worked very well to restore the initial permeability. The cleaning with hydrogen peroxide was also efficient and could be a good alternative product to chlorine (permeability recovery of 80%). This showed that a backwash sequence is more efficient as it directly puts the cleaning agents in contact with the internal fouling inside the membrane. Nevertheless, using oxidising products under backwashing is also a way to put those corrosive products in contact with the membrane which could be harmful for the constituent material and contribute to membrane ageing.

Tests at full-scale. Following the lab-scale trials and autopsy results, two intensive cleanings were performed on the inge industrial modules: one with chlorine of 2h followed by one with citric acid of 2h by using filtration steps (protocol 1) and the other one with hydrogen peroxide of 2h with backwash steps (protocol 3) followed by a cleaning with oxalic acid of 2h with filtration steps (protocol 1). Results showed that both cleanings did not permit a total recovery of the membrane permeability but both cleanings allowed recovering the same

permeability level (Table 8). Therefore, it seems that the use of hydrogen peroxide at pH 11 (when using a backwash step) is an alternative to chlorine. Regular acid cleanings are also recommended to avoid minerals accumulation on the membranes. For these cleanings, citric acid or oxalic acid can be efficiently used.

Table 8. Cleaning tests with the inge membrane

	Fouling and cleaning at lab-scale (seq. 1)	Fouling and cleaning at lab-scale (seq. 2)	Fouling and cleaning at lab-scale (seq. 3)	Fouling and cleaning at full scale
<i>Cleaning products enabling a total permeability recovery (R ~100%)</i>	Cl- 2000 ppm			
<i>Cleaning products enabling a partial permeability recovery (R >80%)</i>	Cl- 200 ppm	H ₂ O ₂ (0.5%)+ NaOH; NaOH;	Cl- 200 ppm; H ₂ O ₂ (0.5%)+ NaOH	
<i>Cleaning products having a low efficiency (R >60%)</i>	Cl- 200 ppm + NaOH; H ₂ O ₂ (0.5%)+ NaOH;			
<i>Cleaning products having a very low efficiency (R >40%)</i>	Oxalic acid; NaOH; Citric acid	Genesys blend; Ultrasil U67/U69		Cl- 2000 ppm + citric acid; H ₂ O ₂ +NaOH + oxalic acid
<i>Cleaning products not efficient (R<40%)</i>	Genesys blend; Enzybras Multi; Ultrasil U67/U69	Enzybras multi;	Genesys blend	

3.4 Conclusions

The results highlighted that the composition of the internal fouling could vary following the used membrane and the operating conditions. In addition, it appeared that the cleaning products have not always the same effectiveness on all types of membranes and the cleaning protocols have to be adapted following the cleaning reagent. Chlorine was efficient on all the membranes but its effectiveness as for the other cleaning reagents was affected when sludge was accumulated into or at the membrane surface. Following the results, it seemed that hydrogen peroxide could be a good alternative to chlorine but must be preferentially used with a backwash step, so that the cleaning product enters directly in contact with the internal fouling inside the membrane pores, without dealing with the external fouling at the surface of the membrane. However, it must be verified that no precipitate can be formed into the membrane in particular when treating waters with high mineral concentrations. The effectiveness of chlorine and hydrogen peroxide on membrane fouling is related to the presence of strong oxidizing free radicals (HOO[·] and HO[·]) deteriorating easily the organic matter and strong hydrolysing alkaline ions present in NaOH. Enzymes products allowed some permeability recovery for the A3 and Polymem membranes. However, they were not yet enough efficient to use them in full scale MBR plants. No results were found with the Genesys blends maybe because the product concentrations were not optimal. Regular acid cleanings must also be performed when minerals from the wastewater accumulated at the membrane surface.

Results also showed that the effectiveness of the alternative cleaning reagents (enzymes products) depended on the membrane material probably because of different affinities with the mixed liquor. Indeed, the membrane deposit differed from one membrane to another. Therefore, the cleaning reagents and protocols have to be adapted to each membrane. The impact of the cleaning agents on the membranes was not investigated in this study. However, the regular use of oxidizing agents could lead to damage of the membrane materials. Moreover, to minimise the risk to the environment, it would be better to use green products rather than oxidizing agents. Further research still has to be done to develop green reagents efficient to clean the membranes. Finally, given the relatively inconsistent results between lab-scale and pilot-scale trials (difficulty to recreate a representative type of fouling), it is advised to validate lab-scale results with full-scale tests.

4 Objective 4. Modelling of biological process

4.1 Introduction

Although it was demonstrated that the usual biological activated sludge models (ASM) developed by IWA can be easily adapted to MBR, kinetic parameters still need to be calibrated to the MBR conditions. In particular, it was proven that parameters such as biomass decay coefficient, mineralization yield, half saturation constant of nitrification and growth rates of organisms may require fine-tuning, especially for operation conditions like high sludge age or low TS content in the influent. The impact of the complete retention of all colloids by the membrane with the reactor needs also some investigation. The AMEDEUS project includes the calibration of an ASM-type biological model for the MBR process, on a wide range of operation conditions (sludge age, temperature) and wastewater characteristics. The calibration was undertaken during long-term operation of two MBR pilot plants operated in parallel with two extreme types of sewage, a municipal wastewater after degritting and after primary sedimentation, in order to cover the broadest range of wastewater conditions and apprehend the impact of particles.

4.2 Material & Methods

Two identical MBR pilot plants of 0.795 m³ were set up at Anjou Recherche, the water research centre of Veolia Environment in France. Pilot n°1 was fed with wastewater of the town of Maisons Laffite after a primary lamellar settler, this pilot is named "*settled pilot*". Pilot n°2 was fed with the same municipal wastewater after pre-screening through a diameter of 1mm punch hole, this pilot is named "*screened pilot*". Sensors and transmitters were installed in order to provide sufficient on-line data to operate the system and calibrate the biological model. Samples from the influent, the effluent and the sludge are extracted for daily analysis.

The biological model used is an activated sludge model ASM1 with Veolia internal modifications such as specific TSS fractionation of the influent (Lesouef *et al.*, 1992). In order to represent the membrane, the model used is a secondary perfect settler. The simulation platform used in this study is WEST (MostForWater, Belgium). A first step was the validation of the systemic representation of the reactor with a lithium tracer test (detailed in public deliverables D33 and D39).

4.3 Results & Discussion

4.3.1 Wastewater characterization and experimental observations

The differences between both types of pre-treated water are: screened water has 30% more solids (TSS = 214 mg/l vs. 151 mg/l) than settled water, and 15% more organic matter (total COD = 541mg/l vs. 462 mg/l).

Besides this first characterization, a fractionation of the COD of both influents was performed, according to the ASM definition and as presented in Table 9. The main results obtained are the following: the global fractionation is close to the default ASM1 for an urban wastewater, X_s fraction (slowly biodegradable fraction) is the easiest fraction to settle, X_i fraction was estimated with this experiment but this variable is also a freedom degree of calibration for the sludge production of the biological process.

Concerning the experimental results, the main figures to underline concern the sludge productions comparison: at a SRT of 15 days, as expected, the screened pilot had a sludge production 27% more important (0.23 gMLVSS/gCOD) than the settled pilot (0.18 gMLVSS/gCOD). When the SRT increased to 40 days, the sludge production

decreased as expected for the screened pilot (0.15 gMLVSS/gCOD), but surprisingly not for the settled pilot (0.21 gMLVSS/gCOD).

Table 9. COD experimental fractionation

	Settled water		Screened water		ASM1
	mg COD/l	% total COD	mg COD/l	%total COD	%total COD
Ss Readily biodegradable fraction	86	33%	86	18%	25%
Xs Slowly biodegradable fraction	99	38%	284	58%	50%
Si Inert soluble fraction	38	15%	36	7%	10%
Xi Particular inert fraction	37	14%	80	16%	15%

4.3.2 Model calibration at SRT 15 days

The first model calibration was made with SRT 15 days' measurement campaign. A steady-state calibration was first performed in order to have a good fit of the level of organic and mineral solids in the biological tank as shown in Table 10.

The main results were that to calibrate the mixed liquor on the settled pilot, X_i has to be decreased to 18% of particular COD of the influent, and to 22% for the screened pilot (experimental value of particular COD for screened wastewater corresponding to 16% of total COD). This explains why in the settled pilot there was a lower sludge production. There is less inert organic particular COD in the influent. Consequently, there is less inert solids accumulation in the settled pilot.

However, results from the experimental fractionation had shown a X_i ratio above the calibration parameter tuned at 18%. Under the decrease of this parameter in the model, one further interpretation could be the bio accessibility behaviour of the substrate within the settled wastewater.

Bio-accessibility is a concept where a molecule (particular or molecule in a complex matrix) is made bioavailable in order to go through the cellular membrane and to be biodegraded (Aquino *et al.*, 2008). Some factors could make a molecule bio-accessible: (i) the increase of contact time between substrate and biomass (i.e. increase sludge age), (ii) the temperature increase, (iii) the hydrolytic activity of biomass (iv) the optimisation of a pre treatment.

In this study, the main difference between both pre-treatments is the removal of a high part of particular matter. The median size distribution of raw, screened and settled wastewater were respectively 64 μm , 53 μm and 15 μm . It is obvious that sedimentation improved the removal of particular matter with a size distribution beyond 64 μm . So, as those molecules are removed, the substrate from settled wastewater has a more bio-accessible behaviour than screened wastewater. Particular matter higher than 64 μm needs more hydrolysis and time to be bio-accessible. Consequently, the specific bacteria growth could be favoured and more important in the settled pilot inducing a sludge production yield less important. Indeed, X_i fraction would contain the organic particle fraction not totally hydrolysed and bioavailable because of lower sludge ages. Furthermore, in both pilot units, permeate COD is slightly overestimated by the model. That can be explained by the membrane retention which further decreases the soluble COD in the permeate (COD_{out}). The calibration can be performed thanks to the inert soluble COD fraction, S_i , enabling to reduce the values of 15% COD soluble down to 9%.

Table 10. Steady-state simulations results and calibration at SRT 15 days

SRT 15 days		MLCOD	MLSS	MLVSS	MLISS	CODout
	<i>Units</i>	<i>g/m³</i>	<i>g/m³</i>	<i>g/m³</i>	<i>g/m³</i>	<i>g/m³</i>
<i>Pilot settled</i>	Experimental data	6025	5533	3811	1722	19
	Before calibration	7135	5040	3444	1581	25
	<i>Difference</i>	-18%	9%	10%	8%	-32%
	After calibration	6126	5376	3711	1665	18
	<i>Difference</i>	1.7%	-2.8%	2.6%	3.3%	5%
<i>Pilot screened</i>	Experimental data	6002	4940	3896	1074	17
	Before calibration	7295	4761	3687	1224	26
	<i>Difference</i>	-19%	7.4%	6.4%	-14%	-53%
	After calibration	6045	4981	3828	1153	16
	<i>Difference</i>	-1%	-1%	0.01%	-0.07%	5.8%

4.3.3 Calibration parameters comparison for SRT 15 and 40 days

Concerning the study at SRT 40 days, the first step was to make a steady-state simulation with the model calibrated at SRT 15 days. The results of the simulations are not detailed but the calibration is summarized in Table 11 which is a comparison of the calibration parameters between both pilots, for the two conditions studied.

For both pilots in all conditions, permeate COD is well predicted, thanks to the S_i value of 9%. This confirms that the COD concentration in the permeate depends also on the membrane retention of soluble microbial products (SMP). But, for the sludge age of 40 days, the model calibrated at sludge age 15 days was not valid for other variables such as mixed liquor concentrations. Concerning the *screened pilot*, the simulations overestimated the COD and MLVSS concentrations at SRT 40 days. In order to calibrate these variables, the inert organic particular fraction of the influent COD was decreased from 25% to 12%. This phenomenon is explained by a sufficient sludge age which allows hydrolysis and biodegradation of a part of the organic matter X_i : the inert organic matter is made more bio-accessible because of the highest contact time (Spérandio *et al.*, 2008, Spérandio *et al.*, 2005, Massé *et al.*, 2006).

Concerning the *settled pilot*, the simulations underestimated all the mixed liquor concentrations at SRT 40 days. To calibrate them, the hydrolysis constant k_h was reduced to a value of 1.03 d^{-1} in order to simulate the accumulation of organic molecules X_S not made bio-accessible yet: Results from the simulation gave a value of 18% of X_S not degraded and remaining in the mixed liquor. Espinosa (2005) used a slow hydrolysis model ($k_h = 0.6 \text{ d}^{-1}$, $K_X = 0.7 \text{ gCOD/gCOD}$) in order to simulate the accumulation of particular matter in a bioreactor until a sufficient SRT is reached to observe a biodegradation of these particles. One hypothesis of this phenomenon in the *settled pilot* would be a lower hydrolytic biomass not acclimatized in the pilot over the trials despite their duration.

Table 11. Calibration parameters comparison for SRT 15 and 40 days

Variables calibrated	Calibration parameters	Default model	SRT 15 days		SRT 40 days	
			Pilot settled	Pilot screened	Pilot settled	Pilot screened
MLCOD	X_I	25%	18%	22%	18%	12%
	k_h (d^{-1})	2	2	2	1.03	2
MLISS	ISS (solubilisable fraction/rate)	(0.5;0.03)	(0.3;0.03)	(0.6;0.03)	(0.5;0.08)	(0.9;0.08)
MLVSS	(COD/SS) biodegradable / no biodegradable	1.2	0.7	0.7		0.6
COD out	S_I	15%	9%	9%	9%	9%
NH_4^+ out	(μ_A, b_A) (d^{-1})	(0.85;0.15)	(0.85;0.15)	(0.85;0.15)	(0.85;0.10)	(1;0.15)
	K_{OA} (g/m^3)	0.5	0.3	0.25	0.5	0.5
NO_3^- out	K_{OH} (g/m^3)	0.2	0.1	0.1	0.05	0.01

4.3.4 Dynamic model calibration

Dynamic simulations allow calibrating the evolution of nutrient concentrations. The results presented originate from the period at SRT 15 days.

Concerning the nitrification and denitrification kinetics, in order to calibrate the concentrations of nitrates and ammonium, and to create a dynamic, a point load was performed in each pilot with an addition of ammonium chloride to both influents.

Nitrification

As Figure 17 (a and b) shows, the perturbations applied to both pilots were calibrated with the decrease of the parameter K_{OA} value (half-saturation constant of autotrophic biomass to oxygen). Decreasing K_{OA} allows an improvement of oxygen transfer, enabling activity even at low oxygen concentration. This point is very important and specific to MBR, as this means that MBR can be operated at low dissolved oxygen to allow decreasing aeration cost. This phenomenon can be accounted for by the smaller floc size distribution (Manser *et al.*, 2005; Jiang, 2007).

In fact, size distribution tests were performed in comparison with a classical activated sludge, and both pilots had the same 50%-quantile (μ_m), about 64 μm , whereas a classical activated sludge (SRT 18 days) had a mean value about 140 μm (Figure 17 c). Authors showed similar differences, Manser *et al.* (2005) found a K_{OA} value of 0.18 gO_2/m^3 for a MBR with a mean floc size of 35 μm and Jiang (2007) found 0.2 gO_2/m^3 for a MBR with a mean floc size varying between 30-50 μm .

In fact, oxygen and ammonia concentrations decrease radially into the floc, whereas nitrite is mainly produced within the floc by the AOB (ammonia oxidizing bacteria) and immediately consumed by the NOB (nitrite oxidizing bacteria). The smaller the floc is, the less dissolved oxygen is needed to achieve nitrification. These authors also have shown that the mass transfer limitation due to diffusion plays a significant role in an activated sludge floc, but is negligible for a floc with a diameter smaller than 100 μm . This the reason why the K_{OA} value was low in both pilots: this value reflects the intrinsic value of the bacteria with a negligible resistance diffusion.

Concerning nitrification calibration at a SRT of 40 days, the couple (μ_A , b_A) was determined by respirometric tests (Table 11) and showed the same trend: the autotrophic biomass is more developed and active because of higher growth rate and lower decay rate values.

Denitrification

To calibrate denitrification (Figure 17 d), the half saturation constant of oxygen of heterotrophic biomass K_{OH} was decreased (default value is about $0.2 \text{ gO}_2/\text{m}^3$). At SRT 15 days, it was decreased down to 0.05 and $0.01 \text{ gO}_2/\text{m}^3$ for respectively the *settled pilot* and the *screened pilot*. Like the nitrification, Manser et al. (2005) showed that the floc size distribution has an influence on oxygen transfer and consequently also on oxygen transfer in the denitrification zone. In fact, many MBR configurations present sludge recirculation from the aerated membrane tank to the denitrification zone: the level of dissolved oxygen plays an important role on the denitrification potential. Dissolved oxygen brought to this zone can inhibit denitrification through the parameter K_{OH} in the anoxic growth reaction modelling. Manser et al. (2005) found a low value of K_{OH} , about $0.05 \text{ mgO}_2/\text{l}$ on MBR, in comparison with a CAS working at the same conditions ($0.16 \text{ mgO}_2/\text{l}$ on CAS). But this parameter depends also on system hydrodynamics and configuration.

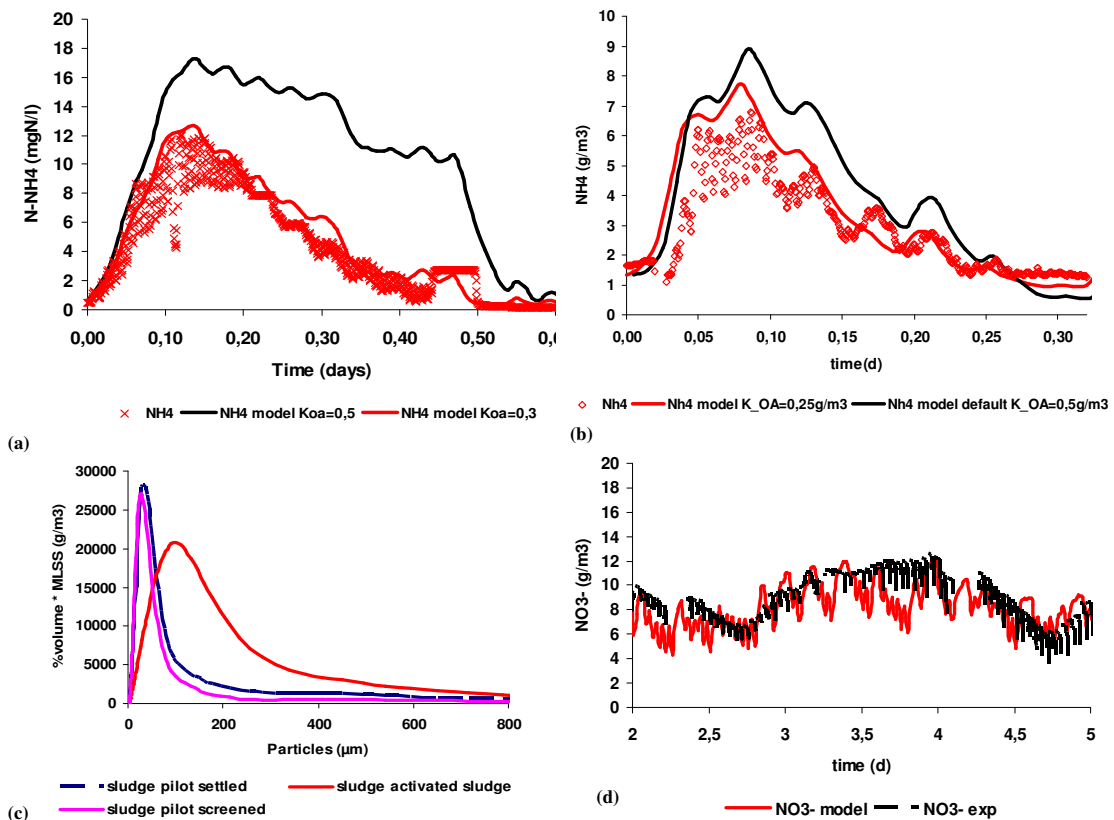

Figure 17. Calibration of ammonia and nitrates, and results from size distribution tests of flocs (a) calibration of ammonia content in permeate for the *settled pilot* after the perturbation, (b) for the *screened pilot*, (c) Size distribution comparisons between sludge from MBR pilots and a CAS, (d) Nitrates calibration for the *settled pilot*.

4.4 Conclusion

Concerning MBR modelling, the first results of this study show that the ASM1 model is able to predict correctly MBR performances for pilot fed by two different influents at 15 days sludge age with the same kinetic parameters, the main difference being the pre-treatment impact on bioavailability of substrate from wastewaters.

In comparison with a CAS, the nitrification and denitrification oxygen half saturation constants are different because of a better oxygen transfer improved by the smaller floc morphology. However, this conclusion is not so general and depends on hydrodynamics and configuration of the process. At high SRT, some biological phenomena appear that are not considered by current biological models. In such conditions, the model prediction potential reaches its limit. One hypothesis is that a pilot fed by screened water has more biomass developed able to biodegrade SMP and EPS in the sludge than a pilot fed by settled water. Nevertheless, some efforts on this aspect were undertaken in modelling research by some authors who propose an ASM1-SMP hybrid model (Laspidou and Rittmann, 2002, Jiang, 2007). The use of this model would allow to possibly validate the hypotheses.

Moreover the permeate COD prediction is independent of the operating conditions and mainly related to the membrane cut-off retention. In the ASM1 model, the calibration can be performed thanks to the decrease of the inert soluble COD fraction, S_i .

The full details on this investigation can be found in the public report D31.

5 Objective 5. Evaluation of the impact of primary sedimentation

5.1 Introduction

High-loaded wastewaters were initially thought to be economically favourable to the MBR technology. However this position was recently reviewed as some designers considered that the use of a primary flocculation / sedimentation stage would enable to reduce the required volume of the biological reactor and the associated operation costs (biology aeration) while increasing the sludge production with the potential for energy recovery through anaerobic digestion. The combination of MBR with advanced flocculation / sedimentation (lamella clarifier, ballasted floc systems, etc) with organic flocculants, could lead to the conception of extremely compact and effective MBR plants. A pilot plant investigation was performed to clarify the issue concerning the impact of the primary sedimentation on the MBR process, and to take advantage of the parallel calibration of the biological model for MBR (Objective 4) to provide a rational reply, based on both technical and economical analyses.

5.2 Results & Discussion

5.2.1 Sludge production comparison

In this first part, the objective is to compare the biological sludge from the pilots, its characteristics, its size distribution and its fractions.

Sludge production comparison in both lines

Concerning the experimental results, detailed in Objective 4, the main figures to underline concern the sludge productions comparison: at SRT 15 days, as expected, the *screened pilot* had a sludge production Y_{obs} 27% more important (0.23 gMLVSS/gCOD) than the *settled pilot* (0.18 gMLVSS/gCOD). The explanation lies in the particular inert fraction (X_i) which was higher in the *screened pilot* and in the model, this fraction was not biodegradable, thus an accumulation of inert matter appeared in the reactor which resulted in a great sludge yield in the *screened pilot* than in the *settled pilot*.

In order to have a complete comparison study, the sludge production from the entire lines (pre treatment and bioreactor) was considered for the period with 15 day SRT (Figure 18). The results of the biological sludge production show that the *settled pilot* produced 16% less excess sludge (140gMLSS/m³) than the *screened pilot* (163gMLSS/m³).

But, if the complete line is considered, the primary sludge production on the settler was on average 71gMLSS/m³, so the total production was 211gMLSS/m³, and on the screen the primary sludge production was only 8 g/m³. Therefore the total sludge production of the system with primary clarifier was about 19% greater than without.

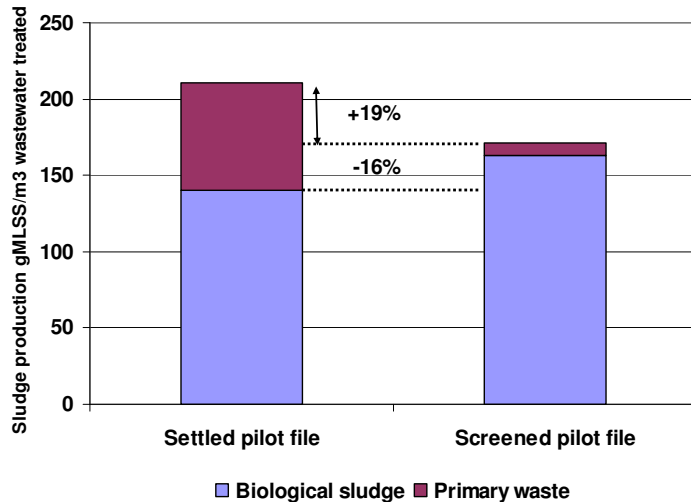

Figure 18. Comparison between sludge generated by biological sludge with sludge generated by the entire file (primary and biological sludge) in both pilots at SRT 15 days

Moreover, with regards to the required reactors volume, as the biological sludge production from the *settled* pilot is lower, this volume of the biological reactor could be reduced, as a direct consequence of the lower concentration of inert particular COD. Considering the COD load, the sludge age, and the sludge production with a MES setpoint of 10gMES/l, the reactor volume could be 30% smaller. The hydraulic residence time (HRT) was as a consequence reduced from 6h in the *screened* pilot to 4h in the *settled* pilot.

Oxygen transfer rate in both lines

Floc size distribution tests were performed for sludge from the *settled* and *screened* pilots in order to assess if the shift of biocenosis due to changing sludge production would impact the floc structure. Figure 19 presents the evolution of floc size distribution during the period at SRT 15 days. Both pilots have the same floc size distribution with d50-quantile values of particles of 35 µm which is stable over the trials period. This implies that (i) the variations of the sludge concentration did not have impact on the flocs size and (ii) this size smaller than a classical activated sludge (about 300 µm) allows a better oxygen transfer to the bacteria whatever the pre-treatment.

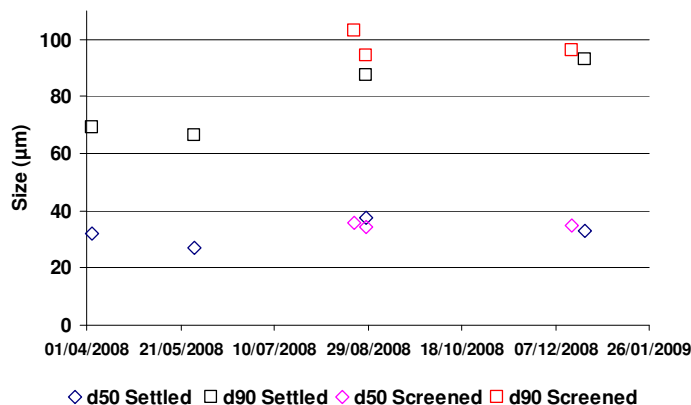

Figure 19. Floc size distribution comparison between settled and screened pilots

5.2.2 Sludge treatment and impact of primary sedimentation

The greater sludge production of the treatment scheme with sedimentation could be interesting when considering biogas recovery through anaerobic digestion for the production of renewable energy. Also to date, no full scale MBR plant was purposely designed with primary sedimentation and anaerobic digestion, the consideration of this process as sludge treatment of large MBR plants is relevant.

In this part, anaerobic digestion is considered for each treatment scheme, in order to validate this hypothesis by biological modelling:

- Sedimentation scheme: primary sludge and secondary excess sludge
- Screen scheme: secondary sludge (waste from screen treated with excess sludge).

By lack of time, experimental BMP (biological methane potential) was not determined for both biological sludge and the mix between primary and secondary sludge. Instead, an anaerobic digestion model (ADM1) was used to simulate the BMP with both sludge types obtained with the biological model calibration of MBRs.

The methodology of simulation was as follows: (i) Definition and calculation of ADM1 fractions from ASM1 fractions using an interface ASM/ADM used on BSM2 (Benchmark Simulation Model n°2, Nopens and al., 2009), (ii) Calculation of fractions from primary sludge after sedimentation and thickener, (iii) Simulation of BMP for secondary sludge of the settled pilot and screened pilot after thickener, and (iv) Simulation of BMP for the mix between primary sludge and secondary sludge from the sedimentation scheme.

Figure 20 presents the ADM1 COD fractions for the different sludge types. Concerning the biological sludge, the main differences are on particulate matter, higher in the screened pilot, as expected, especially on the inert fraction which is more important for the screened biological sludge (inert fraction in ASM1 is considered as inert in ADM1, as proven by Ekama and al., 2006).

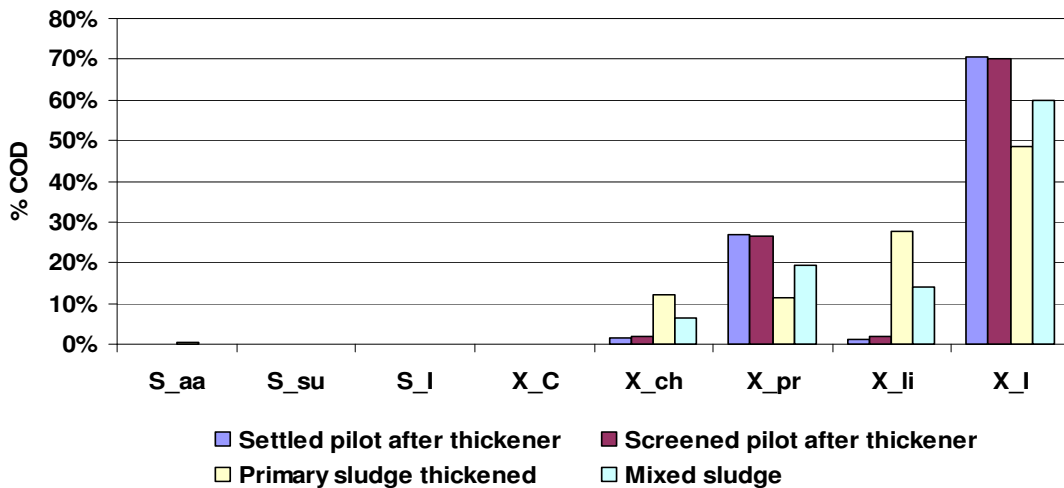

Figure 20. Comparisons of ADM1 fractions for the different sludges considerate

Concerning the primary sludge, as the biodegradable fractions are settled, there are more carbohydrates, proteins and lipids fractions in the sludge, which are all biodegradable fractions in the ADM1 model. The inert fraction is lower because it represents only the fraction X_I from the influent and does not consider the particular inert fraction come from endogeneous products X_P generated by biomass in bioreactors. In his study, Yasui et al. (2008) has shown that there is a little amount of inert organic matter in a primary sludge in a range of only 9-19% X_I .

Figure 21 presents the results from steady-state simulations on a digester with ADM1 under 8d SRT. Biomass initial conditions were the same for all tests. If a comparison is made between both biological sludges, the methane yield generated is higher for the excess sludge from the settled pilot, essentially because it contains less particular inert matter, X_i .

Figure 21. Results of steady-state simulations of anaerobic digestion for biological and mixed sludges

	<i>Units</i>	Secondary sludge from <i>screened</i> pilot	Secondary sludge from <i>settled</i> pilot	Mixed sludge : primary+secondary sludge <i>settled</i> pilot
COD _{in} digestion	kg/m^3	93.53	72.66	28.00
%CH ₄	%	62	64	66
%CO ₂	%	38	36	34
Y _{CH4(mass)}	$kg\ CH_4/kg$	0.22	0.24	0.30
Y _{CH4}	$COD_{degraded} \cdot d$ $kg\ CH_4/m^3$ <i>treated water</i>	0.37	0.39	0.51

With the sedimentation scheme, the production of methane relative to COD biodegraded is higher (28%). This result is the same for the mixed sludge: the methane content in the biomass is better when primary sludge is added on the digester, bringing less inert and more biodegradable matter. In fact, primary sludge content is composed of proteins, carbohydrates and lipids biodegradable, with a methane potential higher than a stabilised sludge. Finally, if the methane yield generated by the sedimentation scheme and screen scheme are compared, (in the *screened* line, the only sludge extracted is the biological one, the waste from screen being sent to domestic garbage treatment), the tendency goes in favour of sedimentation file with 28% more methane produced per volume of treated wastewater.

The double positive effect of settled mixed liquor (more biodegradable and addition of supplementary substrate from the settler) improves efficiently the methane yield. Despite the higher amount of sludge in the complete line of sedimentation, the sludge treatment is a positive effect of this pre-treatment, if anaerobic digestion is considered.

5.2.3 Membrane hydraulic performance comparison

The membranes used in this study were IMMEM membrane module made by Polymem (France). Two modules were installed on each pilot and are composed of hollow fibres representing a total area of 15 m² by pilot.

The filtration conditions of both pilot units were identical during the study: the instantaneous filtration flux normalised at 20°C was between 5 and 10 L/h.m² according to a cycle with 10 minutes of extraction and 30 seconds of backwash (2x filtration flux). Once a week, a cleaning was performed with 500 ppm sodium chloride solution by soaking during 2 hours. In this conditions, the permeability was not stable and reached very low values close to 20 L/h.m².bar corrected 20°C. Changes of modules were necessary because of sludge clogging of modules and many fibres breakages. Given these performances not representing an optimum operation, it is not possible to conclude with respect to the pre-treatment impact on the membrane hydraulic performance.

On the other hand, at the end of the study, Polymem performed microscopical observations under a binocular loop. Figure 22 presents the photography of membranes extracted from the screened pilot. At the surface, many impacts are observed: they are probably due to

particular matter not retained by the screen, as sand which causes such abrasion. The number of fibre breakage encountered with the screened pilot was indeed superior than with the settled pilot. This point could be considered as another interest to use a settler as pre treatment before MBR, or at least an efficient sand trap, to improve the membrane life.

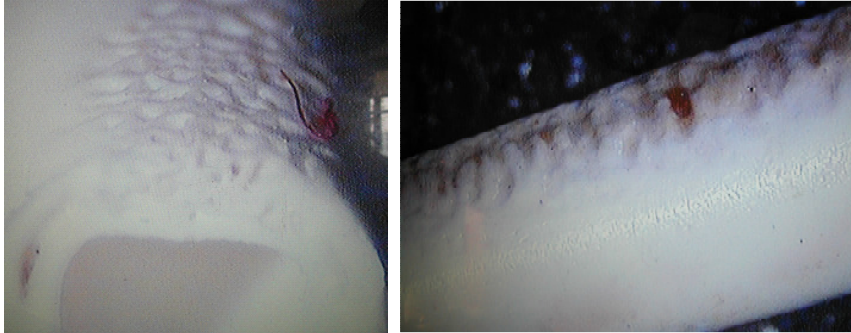

Figure 22. Observations of membranes from screened pilot at the end of the study by a binocular loop

5.3 Economical aspect and conclusions

Pre-treatment is essential for MBR operation since membrane modules are susceptible to clogging with fibrous materials derived from wastewater. It is an important factor in achieving membrane life and minimizing future membrane replacement costs.

In this objective, a comparison between two pre-treatments, settler and screen (1mm punch hole) was carried out, as summarised in Table 12.

Table 12. “resource oriented” comparison of the two pre-treatment schemes

Resource	Unit	Screen	Settler
Total sludge production	gMLSS/m ³	171	211 (+ 19%)
Oxygen transfert rate $k_{l,a}$ (biological reactor)	d ⁻¹	180	180 (constant)
Oxygen demand (biological reactor)	gO ₂ /m ³	570	480 (- 15%)
Volume reduction (MLSS set at 10g/L)	h (HRT)	6.12	4.28 (- 30%)
Methane production	kgCH ₄ /m ³	0.37	0.51 (+ 28%)

The presence of the settler resulted in +19% total sludge production. Some aspects like the oxygen transfer rate is independent of the pre-treatment as the resulting floc size is identical. On the other hand the elimination of the inert matter in the settler allows a lower biological sludge production, therefore reducing the needs of reactor volume by 30% for a set sludge concentration, but also reduced the oxygen requirement for the biology by 15%.

Moreover, if a sludge treatment by anaerobic digestion is considered, the production of methane is of better quality with biodegradable sludge of sedimentation line (28% more methane production). Lastly, it seems that the large particles (like sand) not retained by the screen can damage the membranes. The presence of a settler (or an advanced sand trap) would therefore increase the membrane life.

Concerning costs comparison, many aspects have to be taken into account: (i) construction costs, (ii) membrane replacement and cleaning (iii) sludge treatment.

If construction and operating cost are compared, it depends on the amount of pollution to treat and on the size of the wastewater plant. The main disadvantage of screens is the poor efficiency in removal of the larger particles which induce membrane clogging, and also the water consumption needed to wash the sieve.

Concerning sludge treatment, primary sedimentation produces more total sludge than the screener if sludge treatment does not exist. If the plant is large enough to contain an anaerobic digester, the inconvenience of a screen is the waste disposal. In fact it is considered as a non valuable product and it is incinerated or buried, this aspect induces a supplementary cost. Sludge from primary sedimentation can be treated by anaerobic digestion and can provide a better methane yield, which can be transformed into energy (1m³ of methane represents 6kWh). Another aspect to consider is the cost induced by cleaning and membrane replacement, as membrane alteration could be stronger in the case of screen pre-treatment instead of primary sedimentation.

Because a lack of real data costs, Table 13 presents a simple qualitative comparison of costs generated by sedimentation file and screen file, based on concrete observations.

The full details on this investigation can be found in the public report D31.

Table 13. Qualitative comparison of costs between the two pre-treatment schemes

Resource	Details	Screen scheme	Settler scheme
Membrane	Replacement and cleaning	Membrane abrasion. Maintenance time high.	Membrane fouling lower than screen scheme
Pretreatment	Maintenance	Needs more maintenance time than settler (cleaning, etc..)	
	Waste disposal	Waste disposal from screen: higher cost	
Bioreactor	volume, sludge production, oxygen demand	Higher HRT and oxygen demand. Sludge production higher.	
Total sludge production			Total sludge production higher because of quantity of primary sludge.
Sludge treatment benefit	Biogas generated		Higher total production hence higher methane production potential.

6 Objective 6. Cost-effective positioning of submerged modules.

6.1 Introduction

Submerged MBR modules can be implemented in two different ways. In the integrated system, the membrane modules are set up directly in the aerated biological tank, whereas in the separate system, they are submerged in a separate tank which is dedicated to filtration only (see Figure 23). In the latter case, the membrane filtration tank constitutes an extra biological compartment which contributes to the biological transformation processes.

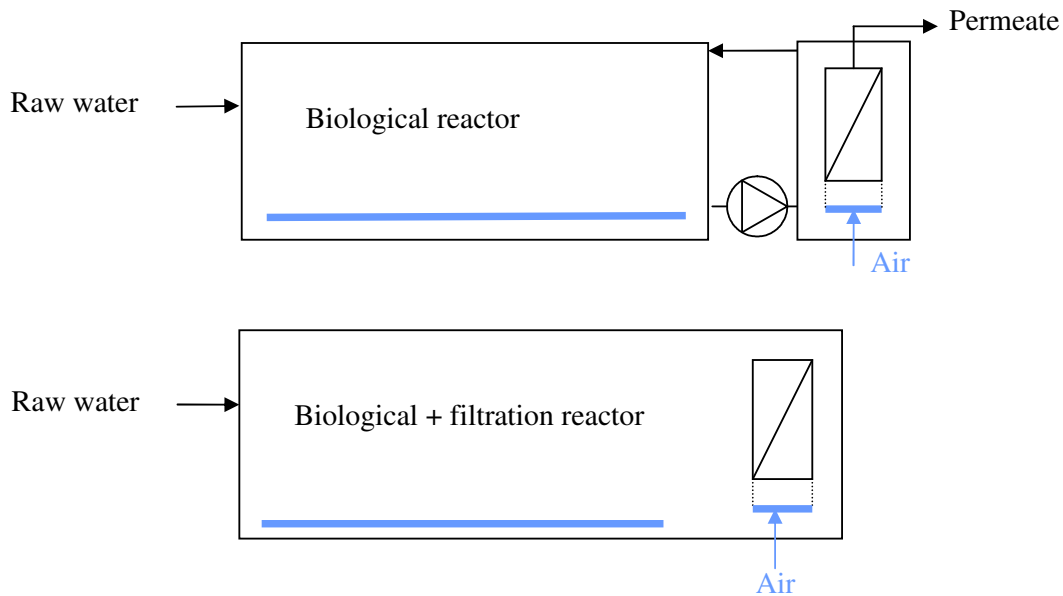

Figure 23. Conceptual representation of separate (top) and integrated (bottom) configuration.

6.2 Trends in Europe on selected configuration

To analyse trends in submerged MBR design, VITO compiled data on full-scale municipal submerged MBR installations which have been commissioned in Europe between 1996 and 2006. For 54 out of 98 plants, sufficient information was available to analyze trends in submerged MBR design. Figure 24 shows that until 2001, only one municipal MBRs had a separate membrane filtration tank, whereas this feature quickly became preferential from 2005 onwards. In general, the choice for an integrated or separate MBR configuration mainly seemed to depend on the membrane configuration. When all flat sheet membrane suppliers were considered, 23 out of 29 full-scale installations were configured without a separate filtration tank. For the hollow fibre membrane suppliers, only 11 out of 25 MBRs were designed as such. This dependence on membrane configuration is most probably related to the membrane and module compactness. As flat sheet membranes are characterized by much lower packing densities, an additional filtration tank would strongly decrease the MBR compactness and would therefore be less desirable.

It could be concluded from our analysis that separate submerged MBRs appeared later in time but quickly became the favoured MBR design for municipal plants in Europe. The integrated configuration is preferred for smaller plants, for flat sheet membrane applications or for systems where only C removal needs to be achieved.

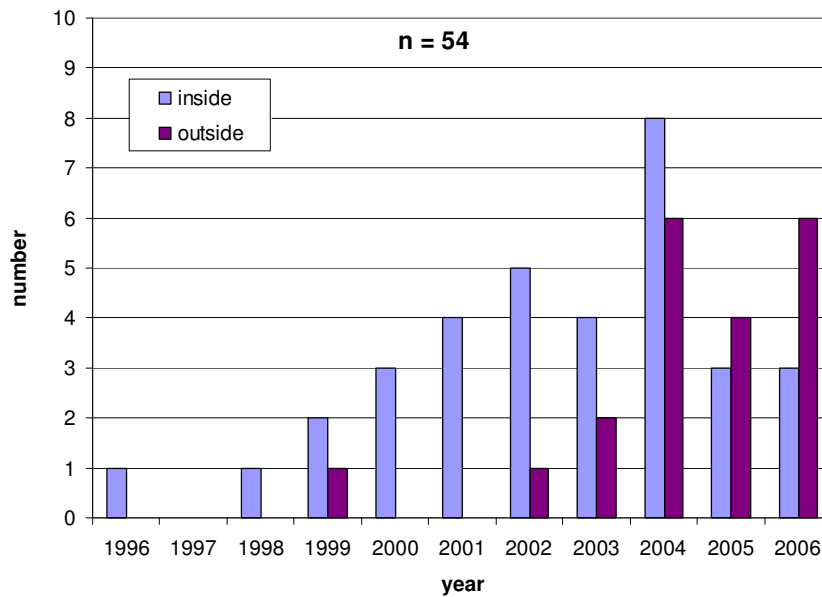

Figure 24. Evolution in integrated and separate submerged MBRs in time. n = number of plants

6.3 Claimed advantages/disadvantages of both configurations

In literature several advantages and disadvantages are claimed for the integrated and separate submerged MBR configurations.

With separate membrane tanks, the membrane module can easily be separated from the biomass and is easily accessible for inspection, maintenance or cleaning interventions. Particularly at high cleaning frequencies, this leads to reductions in energy, time and resources. In addition, the separate layout allows improved chemical cleaning (Wedi and Joss, 2007).

Furthermore, membrane fouling in separate submerged MBRs is lower. On the one hand, this is related to the fact that hydraulics and fluid dynamics can be independently optimized in the separate filtration tank. Sludge distribution in the vicinity of the modules can for instance be better controlled (Lesjean et al., 2008). On the other hand, the biological system can be separately optimized towards reduced fouling potential. Finally, direct contact between the influent and the membranes is avoided, which is beneficial in terms of fouling. Separate membrane filtration tanks also allow for extra control on clogging. Frechen et al. (2007) described how braids can be formed in highly turbulent zones in the bioreactor, even after proper pretreatment. In a separate MBR, the formed braids can be removed before they reach the membranes through additional sieving of the sludge mixture between the bioreactor and the filtration tank.

The separate submerged MBR configuration is said to yield better effluent qualities. First, this is related to the hydraulic retention times (HRT) which determine the achievable effluent concentrations. Since separate submerged MBRs usually have lower MLSS concentrations, their specific volume is larger (Brepols et al., 2005) and this increases their hydraulic buffer capacity. Second, this is attributed to the fact that the separate filtration tank leads to cascading of the total reactor volume, which makes this type of configuration less susceptible to strong fluctuations in feed flow or loading conditions (Brepols et al., 2005; Lesjean et al., 2008).

Particularly when stringent nutrient discharge norms have to be reached, MBRs with a separate filtration tank are recommended (Brepols et al., 2005; Lesjean et al., 2008). This is not only due to their larger buffering capacity, but also due to the possibility to more easily optimize denitrification. When alternating anoxic/aerobic cycles are applied in the bioreactor, the separate configuration is a favoured option.

Separate submerged MBRs show a higher operational flexibility when operating in several parallel lanes. As stated by Brow (2007), one aeration tank can be isolated and flow may continue from the remaining aeration lanes to all filtration tanks. In an integrated layout, both the biological capacity of the tank and the hydraulic capacity of the membranes in that lane would not be available.

The use of a separate tank evidently also creates some disadvantages. First of all, it results in a larger footprint than for the integrated concept. Secondly, investment costs are larger than for an integrated configuration due to the costs for construction of extra tanks and for recirculation pumps. Finally, operational costs are higher. These mainly relate to aeration for membrane scouring and pumping to recirculate the mixed liquor to the filtration tank. However, even for integrated MBRs, sludge recirculation to the head of the tank is applied to avoid sludge accumulation near the membranes. While the coarse bubble aeration directly contributes to oxygen supply in integrated submerged MBRs, this is much less the case for the separate set up. One may therefore expect that the costs for oxygen supply will be higher in the separate configuration. Tao et al. (2005) indeed noticed the lowest air to permeate ratio for a MBR pilot which combined aeration and membrane tank in one.

A comparison of energy consumption for full-scale plants shows that the ranges are fairly similar (see also 6.4). Where Ertverband claims energy consumptions of 0.8 kWh/m³ for the integrated MBR in Nordkanal (Germany), the separate Varsseveld MBR (The Netherlands) has a yearly average of 0.88 kWh/m³ which can probably be further reduced to 0.75 kWh/m³ through further optimization (van Bentem et al., 2007).

6.4 Comparison of full-scale systems

Among the operational full-scale municipal MBRs, two installations were selected because they are equipped with the same membranes, have different submerged MBR configurations and sufficient operational and cost data are available, either through literature or through contacts with the operator.

These were

- Kaarst, Germany (Nordkanal, Ertverband): integrated submerged MBR
- Varsseveld, the Netherlands (Water Authority of Hollandse Delta): separate submerged MBR.

The plants are equipped with Zenon membranes and have comparable designs in terms of pre-treatment and biological treatment. Target MLSS values were similar in both cases, but the design flux was 50% higher in the Varsseveld case. Discharge consents were more stringent for Varsseveld, in particular for N and P. As expected, the Varsseveld plant has a separate submerged MBR design. The main difference in design parameters is the 3-4 times higher capacity of the Kaarst plant.

Both plants are operated under similar conditions of organic loading, hydraulic retention time and sludge age. Yearly average operational fluxes are similar in Kaarst and Varsseveld and amount to 7-9 l/m².h. As these are important factors determining sludge quality and hence fouling behaviour, no large differences in fouling are expected. As the plants are currently both using intermittent aeration, the specific aeration rates are fairly similar when expressed per m² or per m³ of permeate produced. Physical and chemical cleaning is analogous as well and is probably more related to the selected membrane type than to the MBR configuration.

Information on the frequency of intensive cleans could not be found, but there are no indications that these would differ significantly between the considered plants.

The relative footprints conform the general assumption that separate MBRs occupy a larger surface area than integrated ones. For Varsseveld, the total footprint of the bioreactor and membrane filtration tanks was calculated to be 792 m². In Kaarst it covers a surface area of 2 430 m². When these values were backcalculated per population equivalent (PE), the Kaarst MBR is the most compact one.

Table 14 gives an overview of various cost items. Energy consumption turns out to be similar for the Kaarst and Varsseveld plants. For both, further optimizations are planned. The total capital costs evidently depend on the plant size. Expressed per PE (design value), the integrated MBR in Kaarst is cheaper. Also when the actual treated flow is considered, the capital costs are significantly lower than those of the Varsseveld plant. When the operational costs are calculated per PE, the Kaarst plant again appears as the most cost effective one. Even when the actual treated volume is considered, the operational costs are only 70% of those in the separate Varsseveld MBR. These data confirm the expert opinions that separate MBRs have higher investment and operational costs than integrated ones. However, economy of scale play a role here as well.

Table 14. Comparison of cost related parameters for the Kaarst and Varsseveld MBR plants (Brepols, 2008; Judd, 2006; STOWA, 2006; van Bentem et al., 2007; www.mbrvarsseveld.nl).

Parameter	Kaarst	Varsseveld
Energy consumption (kWh/m³)		
<i>Total specific power demand</i>	0.9	0.9
Membrane aeration	0.23	0.34
Membrane supply pumps	0.03	0.11
Permeate pumps	0.04	0.12
Bioreactor aeration	0.30	0.24
Bioreactor impellers	0.05	0.04
Others	0.25 (incl. sludge dewatering)	0.05
Costs		
<i>Capital costs (MEUR)</i>		
total	21.5 (excl. transport pipe)	11.2
capital cost (EUR/PE)	269	487
capital cost (EUR/m ³ /d)	1 499	2 240
<i>Operational costs (kEUR/yr)</i>		
total	1 343	658
operational cost (EUR/PE)	17	29
operational cost (EUR/m ³ treated)	0.26	0.36

Table 14 already indicated identical energy consumptions at the integrated Nordkanal and separate Varsseveld plant. The relative contribution of membrane aeration is clearly lower in the integrated MBR. For bioreactor aeration, the trend is opposite. For the total aeration requirement, the procentual contribution is slightly higher in Varsseveld (64%) than in Kaarst (59%). The presence of coarse bubble aeration in integrated submerged MBRs therefore seems to reduce the overall aeration requirements. These results are in line with the observations of Tao et al. (2005) that an integrated MBR pilot had a significantly lower aeration requirement than two separate ones. As expected, the contribution of membrane supply pumps is much lower in the Kaarst plant than in Varsseveld and the contribution of the bioreactor impellers is slightly higher.

For more details, we refer to deliverable report D38 and De Wever et al. (2008).

6.5 Decision tree for submerged MBR systems

From the above it is clear that the separate configuration provides the highest flexibility in operation and allows independent optimization of biological and membrane processes, but this goes with a higher investment and operational cost. As a summary, a decision tree was tentatively compiled which indicates the major factors affecting the choice for an integrated or separate MBR configuration. This is shown in Figure 25.

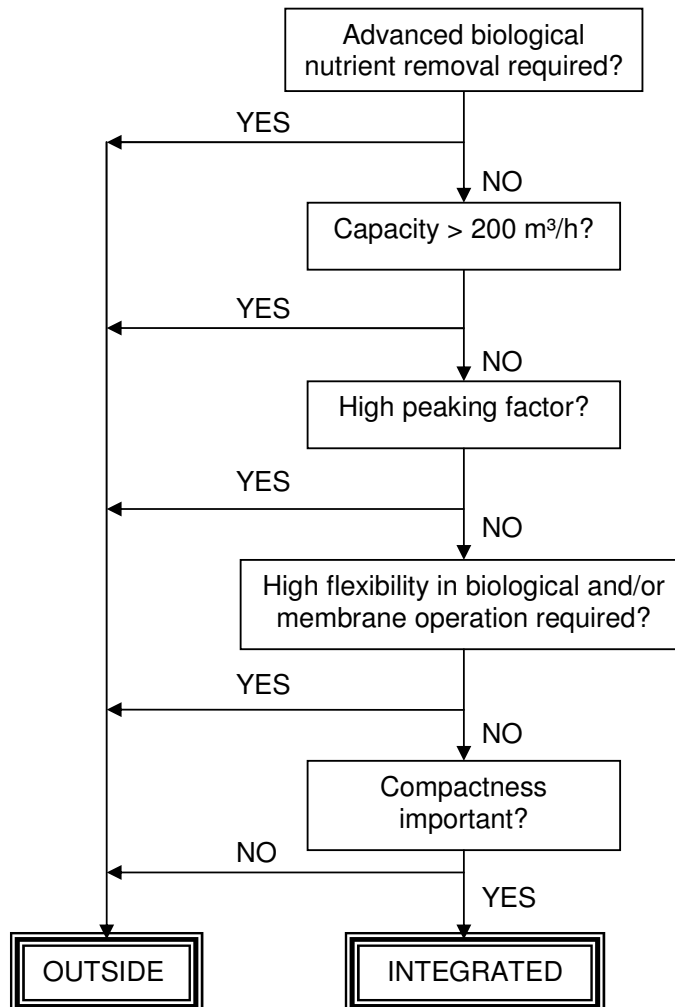

Figure 25. Decision tree for submerged MBR design.

7 Objective 7. On-line data acquisition and advanced filtration control system

7.1 Introduction

Few data is available on optimised or dynamic control of filtration conditions in MBR plants. Such a data acquisition and control system could provide the following advantages: easier reporting on relevant operation parameters, diagnostic of disturbance or drifts in process conditions, operation assistance (prediction of next cleaning, sludge management, maintenance actions, etc, crucial for remote control of remote plants and organisation of interventions at lower labour costs), and dynamic control and optimisation of filtration parameters. This latter aspect would be very beneficial for larger plants, as it would optimise

the filtration regime (backwash length and intensity, filtration length, aeration intensity, etc) according to instant fluxes, coping best with daily or seasonal profiles. It should therefore enable to optimise operation costs (productivity increase, increased average sustainable filtration flux, and average energy consumption decrease) while reducing stress on the membranes, optimising backwash frequency and chemical cleanings, and reducing membrane aeration requirement. Moreover such a system would optimise automatically the filtration conditions in periods of peak flow or fouling events which can be much detrimental to the membranes. This would lead to an increased lifespan of the membrane modules. Such an advanced control system (ACS) could also incorporate the findings of Objective 2: the development of on-line fouling sensors, and the identification of control strategy. Such a development on data acquisition and advanced filtration control system of MBR technology was performed within the project backed up by a comparative test on a pilot plant unit performed on premises of Aquafin.

7.2 ACS development

The control of the process parameters of a MBR filtration system can be based in practice on a PLC or a PC software oriented control (e.g. the MeFiAS® LabVIEW based software of VITO). In both cases the set points of the different filtration system operational parameters need to be defined and their value set. This is done by the human operator on the basis of the MBR system builder experience or possibly his/her own experience. As a result, such set points are often fixed at the very start of a new MBR installation and only adapted in a minor way during operation, evidently with the risk of the MBR largely underperforming e.g. because of needless excess aeration. It is therefore obvious that an additional advanced control system (ACS) which is able to change the values of the set points in an automatic way and a flexible and more optimized way would be of large importance. The ACS is then on top of the basic control system and in fact supervises the functioning of the (hierarchical “lower level”) basic control system (see Figure 26).

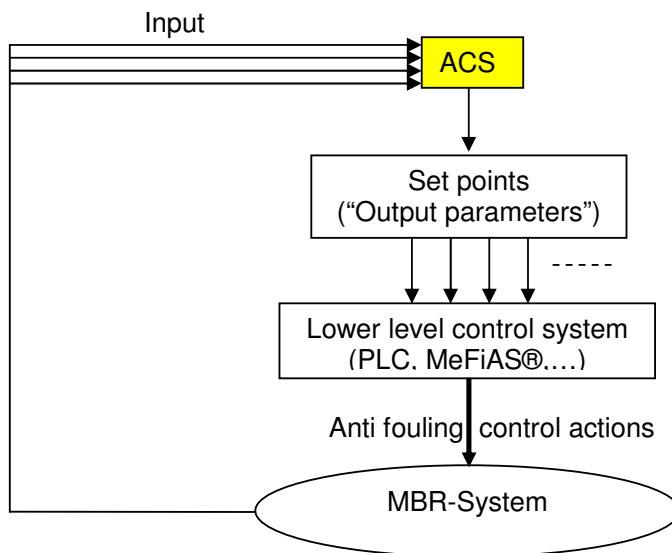

Figure 26. Concept of advanced control system (ACS) approach

The ACS was built from the scheme presented in Figure 27. Per set point, the ACS holds a Fuzzy Set Logic (FSL) control block. As a standard, one FSL control block consists of :

- a fuzzification module that fuzzifies the incoming relevant sensor values
- a logical inference module that uses the process knowledge within the fuzzy rules module to calculate the fuzzy response

- a defuzzification module that translates the fuzzy output of the logical inference module into one crisp value, which is then the new value of the corresponding set point.

The possible set points that are linked to the control of the filtration process in a MBR are linked to two possible fouling modes: reversible and irreversible. In the first case, mechanical actions such as aeration or backwash are targeted, in the second case e.g. the frequency of maintenance cleans. For each output variable or set point, there is a FSL control block which also needs appropriate inputs. It is obvious that fouling propensity data of the mixed liquor of the MBR are the primary inputs in the case of an ACS which aims to control the filtration performance. Evidently, all ACS control blocks which are predominantly linked to the (ir)reversible fouling propensity will need fouling data on (ir)reversible fouling. Such inputs can be delivered by the MBR-VFM (VITO Fouling Measurement), which was also developed in AMEDEUS (see Huyskens et al. (2008) for further details).

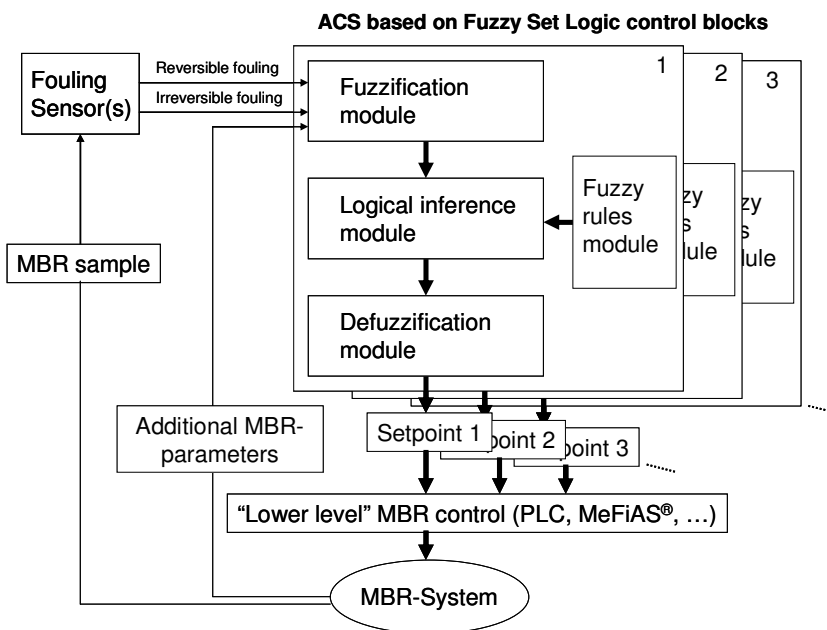

Figure 27. Advanced Control System (ACS) scheme

Next to the input of the primary reversible or irreversible fouling propensity data from the MBR-VFM and the image recognition system, other MBR parameters can also be considered as ACS input parameters (Figure 27, 'additional parameters'). Appropriate MBR input parameters are linked per set point to their corresponding control block. The ACS stand-alone software is directly supervising by communication channels the "lower level" filtration software (e.g. MeFiAS®) to automatically set new filtration related set point values and thus optimize the filtration performance of the MBR.

An important feature of the ACS software is the integrated normalization enabling a universal implementation. For all MBR input and output parameter values a minimum and a maximum are defined and then first converted in the ACS into a normalized percentage between 0 and 100%. They are depending on the MBR plant and thus fixed by the operator. This generates a very flexible and adaptable ACS, which can be used for all MBR plants with their differences in membrane modules, process modes, process conditions, etc. The ACS is also capable of showing a log of messages to the operator to inform about which control actions were taken at what instant and also about the main driver for those actions. In this way the operator is able to learn about the behaviour of the MBR.

7.3 ACS validation

After the development of the ACS software and its functionalities, the system was validated and further finetuned during MBR pilot trials on municipal wastewater. The total test duration was 1.5 years. A first stage consisted of three test blocks in which test periods without and with ACS control were alternated at increasing complexity. In the second stage, dynamic flux conditions were investigated. The focus of the ACS validation was on filtration optimization and more specifically on reversible fouling actions, such as aeration and relaxation period. During the ACS tests, the active input parameter settings were used to generate automatically the set points of the output variables which were then transferred to the pilot plant MEFiAS® control software. This occurred on a daily basis.

In the three test blocks with alternating lower level and ACS control, fluxes were kept constant at 15 or 20 l/m².h. It could be concluded that the ACS settings, obtained in response to the measured fouling behaviour, reduced the specific energy demand of the MBR by 35-45% (see also Table 15), but that this could imply an increase in TMP (see Figure 28 for test block 2 results).

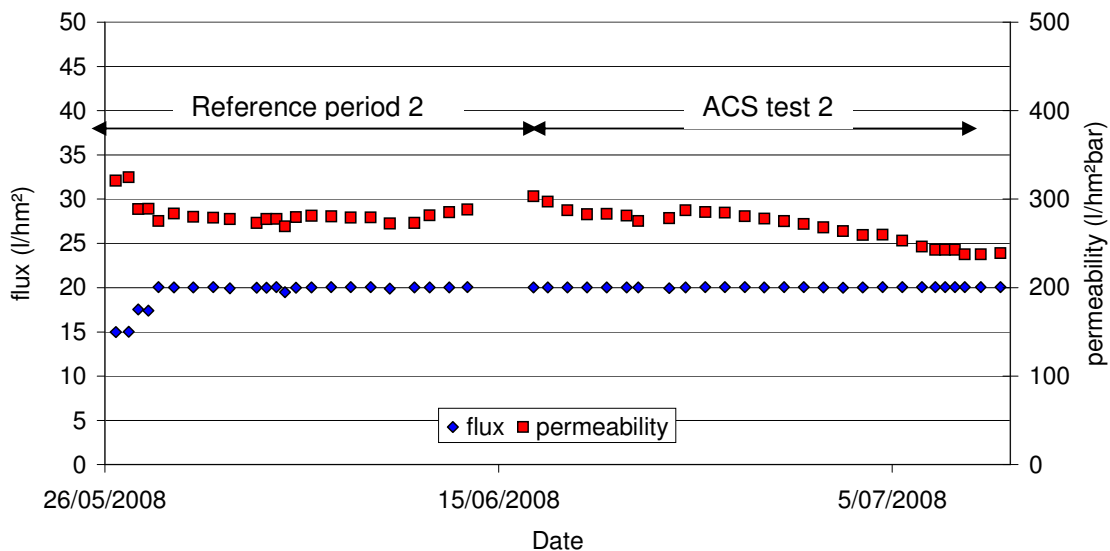

Figure 28. Evolution in flux and permeability during test block 2.

In the period of dynamic operating conditions, fluxes were increased to 130% for 6 h and then decreased to 90% of their value for 18 h twice a week, resulting on average in the target flux. Figure 29 shows an extract of the permeability data during dynamic operation, referring to a reference period and an ACS control period in which maintenance cleans were applied. Apparently, the permeability showed a gradual decline under lower level control of the MEFiAS® software. The variable flux pattern applied during ACS testing with temporary flux increases to 26 l/m².h did not change the slope of permeability decrease, despite the reduction in membrane aeration.

In the test period without maintenance cleans, quite challenging conditions occurred in addition to the variable flux patterns. The permeability trends could be related to the mixed liquor properties and operational parameters. Higher than usual levels of several fouling indicators correlated with severe fouling and coincided with periods of low temperature and heavy sludge wasting. Both conditions thus seem to have induced changes in mixed liquor composition which accelerated fouling. Interestingly, the reversible MBR-VFM values were mirror images of the on-line permeability values. The MBR-VFM thus proved to be a suitable ACS input parameter to evaluate instantaneous mixed liquor fouling propensity and as such predict fouling.

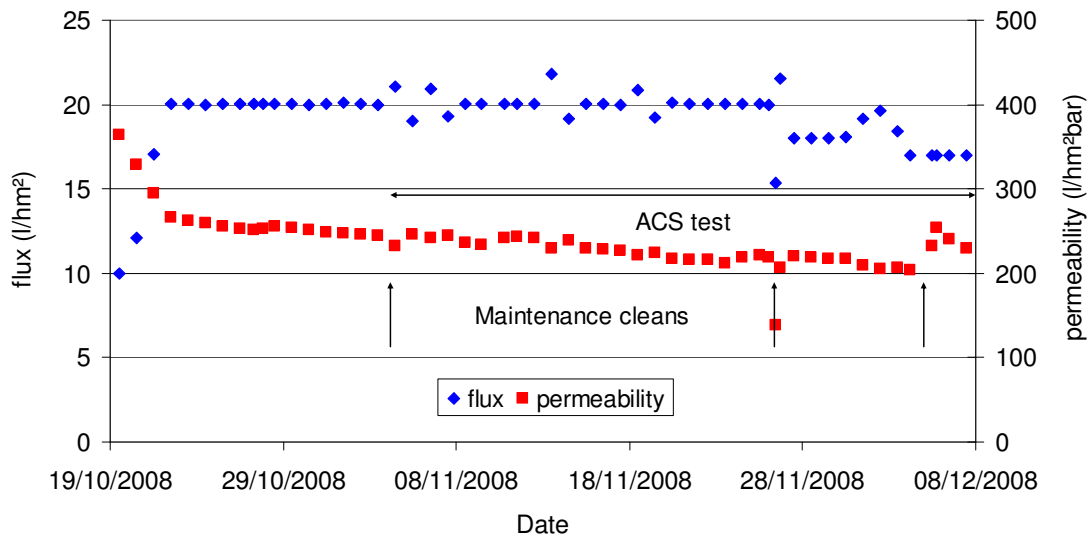

Figure 29. Evolution in flux and permeability during dynamic flux operation. Upward arrows refer to maintenance cleans.

7.4 Overall evaluation

The actual aeration flowrate setpoints generated by the ACS are summarized in Table 15 for the various test periods. Aeration flowrate was fixed between 10 and 18 Nm³/h. In the first test block, the flux was not considered as an input parameter. Aeration rates were therefore similar in filtration and relaxation mode. In the second and third test block, the flux was an additional input parameter. Due to very low MBR-VFM fouling values and warm temperatures, the generated setpoint for aeration during the relaxation phase was minimal. In the dynamic flux test period, the output parameter range for membrane aeration was reduced to 12-18 Nm³/h. The average aeration rates in both the relaxation and filtration phase, were thus higher. Furthermore, various settings were adapted and fine-tuned. This explains why the set point during relaxation was now different from the minimal value.

Table 15. Average aeration rates (Nm³/h) during the different test periods.

	Filtration		Relaxation	
	Reference	ACS test	Reference	ACS test
Block 1	18	10	18	10
Block 2	18	11	18	10
Block 3	18	12	18	10
Dynamic testing	18	14	18	13

According to Table 15, energy savings for membrane aeration amounted to 22% in the filtration stage and 28% in the relaxation stage for the fine-tuned settings in the dynamic testing period. This corresponds to an average saving of 23%, but may imply a stronger decrease in permeability as observed during some of the alternating test blocks, albeit at much lower aeration rates of 10 Nm³/h. Total aeration requirements in a submerged MBR are the sum of the aeration needed for oxygen supply to the biomass and the coarse bubble aeration for membrane scouring. In our case, it was impossible to see the impact of reduced membrane aeration on oxygen supply to the bioreactor, since the latter was controlled on/off to reach a preset oxygen level and this frequency depended on the wastewater quality, which was variable in time.

As an example of a MBR system with a separate filtration tank, energy consumption data for the MBR in Varsseveld were used (STOWA, 2006). These indicated that membrane aeration amounted to 0.34 kWh/m³ for a total aeration demand of 0.58 kWh/m³ and a total energy demand of 0.9 kWh/m³. If we thus assume an average energy reduction of 23% for membrane aeration and no impact on fine bubble aeration for oxygen supply, the energy gain would amount to 0.08 kWh/m³ or 10% in total. Total energy costs at the MBR of Varsseveld were estimated at 104 kEUR/year and could thus be reduced by 10 kEUR/year if an ACS were implemented. For larger plants with higher yearly energy costs, the picture may be even more advantageous. For the Kaarst plant in Germany for instance with a capacity of 12 000 m³/d, energy savings could amount to 35 kEUR/year.

7.5 Conclusions

An operational ACS was developed which was validated on a MBR pilot unit with a gradual increase in complexity of selected input and output parameters. The ACS had an understandable interface and allowed for clear logging of changes operational conditions. A first series of demonstration tests was performed on a MBR pilot unit. This showed that the MBR-VFM measurements correlated well with on-line permeability and are thus a suitable input parameter for the ACS. The tests also showed that an average 20% reduction in membrane aeration requirements could be achieved, although this sometimes went at the expense of a stronger permeability decline, and could thus result in a higher cleaning frequency. Detailed results on 1.5 year of pilot testing with the MBR-VFM as input for an ACS are reported in deliverable D51.

8 Objective 8. Optimised integration and control of MBR system in case of plant refurbishment.

8.1 Introduction

More stringent effluent standards and increased biological and hydraulic loading trigger the need to extend existing treatment capacities at municipal wastewater treatment plants (WWTP). Because of the limited footprint and enhanced treatment efficiency, among others, membrane bioreactor (MBR) technology is an attractive technology for the retrofitting of a WWTP. High investment costs form a major drawback for the implementation of this technology in a refurbishment action. Dual configurations, combining conventional activated sludge (CAS) technology and MBR-technology are a means to increase the cost-effectiveness of the refurbishment. During the project, Aquafin has investigated the technical feasibility and the market potential of 2 schemes integrating this idea: Dual 1 and Dual 2® (Figure 30 and Figure 31).

In conventional MBR design, sufficient membrane surface has to be provided to treat the full maximum flow. The main idea behind this Dual technology is to treat the average flow in dry weather in the MBR lane and to divert the peak flows in rain weather over the final clarifier of the CAS. In this way the membrane area, which has a serious impact on the investment cost, can be reduced. The main difference between Dual 1 and Dual 2® is that in the former the CAS line and the MBR line have separate aeration tanks, while in Dual 2® there is only one bioreactor feeding both the filtration tank and the final clarifier.

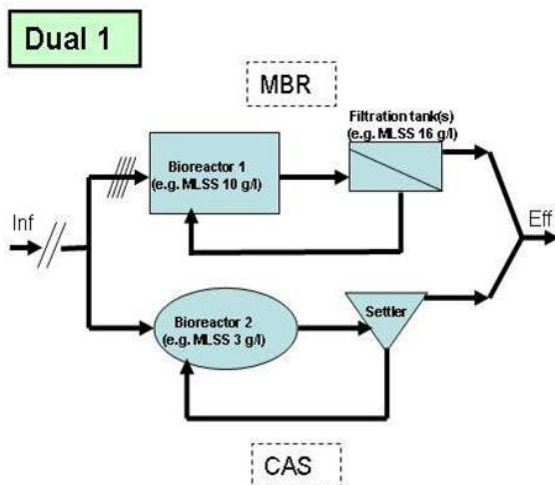

Figure 30. Dual 1 configuration

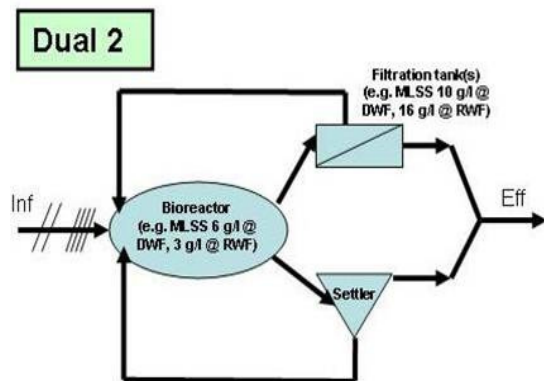

Figure 31. Dual 2 configuration

8.2 Objectives

Since there are multiple aspects involved in determining the optimal design and control of Dual systems, the objectives were divided into 3 subtasks:

1. Evaluation of the process performance and optimisation of the control of the dual CAS-MBR configuration 1 (DUAL 1).
2. Evaluation of the technical feasibility of the dual CAS-MBR configuration 2 (DUAL 2) and, if feasible, determination of the key design and operational parameters in view of plant upgrade.
3. Analysis of plant upgrade potential with the (two) dual CAS-MBR configuration(s) in the EU Accession and Associated Countries for existing conventional activated sludge plants to meet the *Acquis Communautaires* standards for sewage treatment and disposal.

8.3 Optimised control strategy of influent split for MBR/CAS Dual 1 concept

Evaluation and optimisation of the Dual 1 flow repartition

Initially, an exploratory study was performed on alternative control strategies for the flow repartition of the inflow to the combined CAS–MBR configuration (Dual 1 concept) of the Schilde WWTP, Belgium. The main goal was to find an adequate flow repartition between the MBR and CAS lane in order to make optimal use of the existing tank capacity and consequently reduce the risk of non-compliance with the effluent nitrogen norms. This is necessary because of the severe biological overloading at the WWTP of Schilde.

A model of the Dual 1 system of Schilde was built with the goal of comparing the flow repartition control strategies in their merits. Calibration indicated that the developed Dual 1 model of the Schilde WWTP was suitable for controller evaluation and development.

The model-based analysis revealed that pure feedback control provides limited margin of improvement. The implementation of a feedforward/feedback flow repartition control algorithm seemed on the other hand a meaningful option. It was observed that flow repartition alone was not sufficient. Dosing of coagulants in the primary clarifiers, to enhance the primary clarification and reduce the load to the CAS lane, was necessary too. In the next phase, the newly developed model-based feedforward/feedback control was implemented and tested on full scale at the Schilde WWTP.

The feedforward action is based primarily upon two water quality signals, namely the ammonium and the suspended solids concentrations, measured on-line in the WWTP influent. The algorithm is based on a simplified version of the International Water Association Activated Sludge Model 2D (ASM 2D). Iron chloride was used as a temporary expedient to relieve the overloaded CAS unit by improving the efficiency of the primary sedimentation (enhanced primary clarification, or EPC). In the evaluation period, the control algorithm slightly underestimated the nitrogen removal performance. The simulations prove that this is to be attributed primarily to the safety factors applied to the algorithm's parameters. Conservative parameter values were used for both the estimation of the influent load and the nitrifiers' kinetics. Since there are no indications of significant shifting of model parameters over time, the conservative parameter values were relaxed after the evaluation period.

Comparing the full-scale effluent results before and after the implementation of the new control algorithm, it could be seen that the nitrogen removal efficiency on a yearly basis increased (over 10 points under dry weather flow conditions, and 5 points when considering the complete data set). While the overall total nitrogen load in the WWTP effluent remained virtually unchanged, the influent load during the evaluation period of the new control algorithm was more than 10% higher than during the evaluation period of the original control algorithm. The improved removal efficiency is mainly due to the fact that the controller triggered a higher denitrification time in the intermittent aeration basin of the CAS lane during the warm, drier season. The yearly averaged effluent quality during dry weather flow can be seen in Figure 32. The same trends were also experienced for rain weather flow. As expected, the extent of the improvement progressively decreases at increasing inflow.

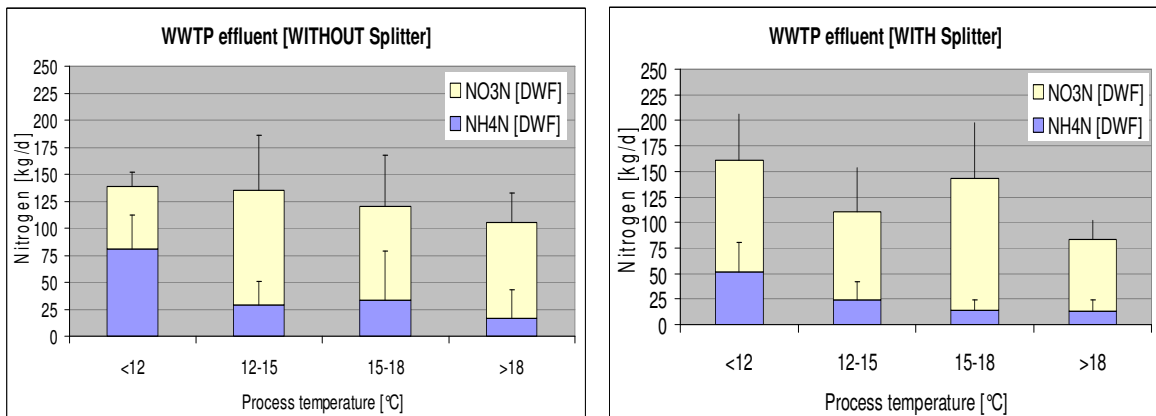

Figure 32. N load in the WWTP effluent during dry weather: (left) previous and (right) new control strategy

The nitrification activity could be maintained in the CAS lane for two consecutive winters: the control system avoided the flush out of the nitrifiers. However, as it was expected by the theoretical study, at water temperatures below 12°C the new flow repartition did not lead to statistically significant improvements in the TN removal performance (i.e., the extra TN load coming in was merely converted into nitrate, see Figure 32).

The compliance problems associated with wet weather flows were mitigated, yet the risk of non compliance is still high. The full scale tests showed that enhanced primary clarification is effective as a temporary expedient to relieve the overloaded CAS unit (Figure 33).

In conclusion, the newly developed controller seems promising and its use at WWTP Schilde was extended beyond the evaluation period. Nevertheless, this will not suffice to cope with the severe and increasing pollutant overloading, and an extension of the biological treatment seems to be necessary in the coming years.

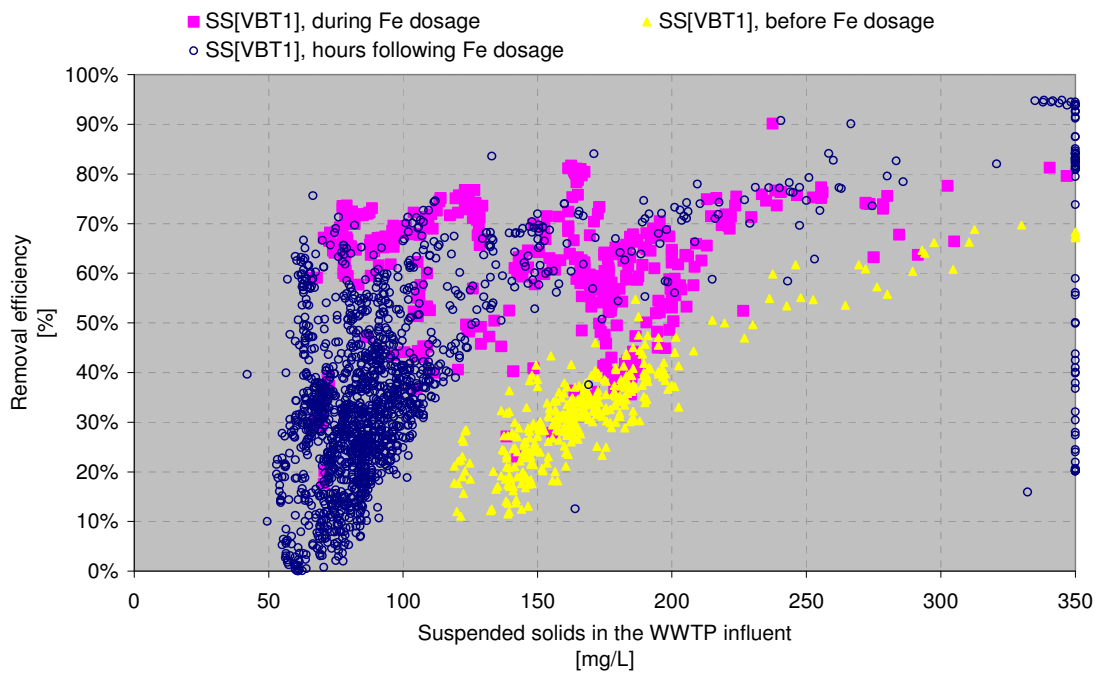

Figure 33. Removal performance of primary clarifier 1 with and without coagulant dosage

Hydrodynamic modelling

A numerical simulation by means of CFD software was performed to determine the hydrodynamic properties of the anoxic and aerobic tank of the MBR lane in the WWTP of Schilde. Since the aerobic tank was operated with an intermittent aeration pattern, the simulations were performed both for the cases with and without aeration. For the aerated case, the simulation results were compared to actual stream velocity measurements at different water depths and a good agreement was found. Based on this finding, the validity of the numerical results was also assumed in the non-aerated case.

In the case without aeration, large regions with low velocities were identified in the centre of both the anoxic and the aerobic tank. This implies the risk of sedimentation and only a partial use of the reactor-volume. Furthermore a shortcut flow was discovered between the recirculation inlet and the outlet of the aerobic tank, which was even more pronounced during the aerated phase. A schematic overview of these findings is shown in Figure 34.

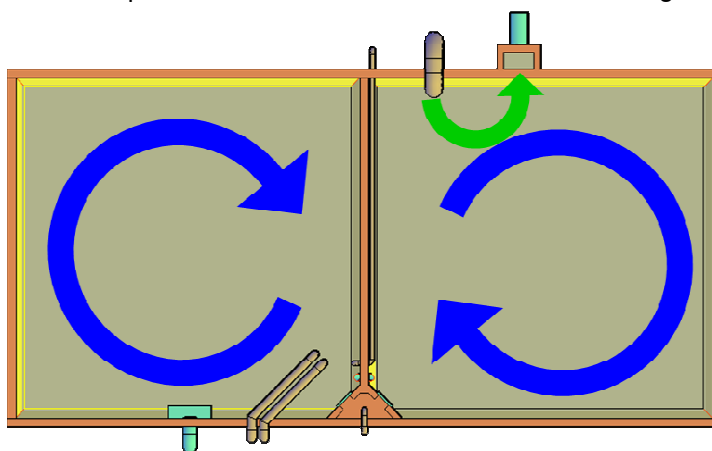

Figure 34. Schematic flow field in the anoxic (left) and aerobic (right) tank of the MBR-lane of the Schilde WWTP (bird view)

Considering that radical changes in geometry are not possible, a couple of suggestions were made to counteract the detected problems. These included the installation of an extra mixer in the anoxic tank, baffles to direct the flow and an increase of the distance between recirculation inlet and outlet of the aeration tank.

8.4 Pilot evaluation of design and control for MBR/CAS Dual 2 concept

At the wastewater treatment plant of Schilde a pilot plant was installed to investigate the technological feasibility of the Dual 2 CAS–MBR concept. One of the main concerns in determining the feasibility of the Dual concept is the settleability of the sludge. The sludge properties and concentration are different in an MBR system as compared to a conventional activated sludge configuration. Since in this Dual 2 scheme sludge from the MBR filtration tank is pumped to the final clarifier at the start of a peak flow, good settling characteristics need to be guaranteed. The parameter used here to characterise this settleability is the sludge volume index (SVI). The repercussions on the effluent quality, specifically the concentration of suspended solids, were also taken into account to determine whether the effluent standards could be met.

The pilot-scale experiments were performed in three periods. In the first experimental period (Period 1), only the conventional activated sludge mode (with clarifier) was operated to determine the boundary conditions for a stable mode of operation. In this period some bottlenecks of the pilot plant were detected, and some improvements were implemented. In period 2, the filtration tank was operated in parallel with the clarifier and with a constant flow regime. The sludge quality (SVI) and the effluent quality of the clarifier (concentration suspended solids) obtained in this hybrid mode of operation were compared with the values obtained in the first experimental period. In the hybrid mode adequate effluent quality results were obtained, and the sludge settling quality remained good. This indicated the potential of the Dual 2 concept for further development.

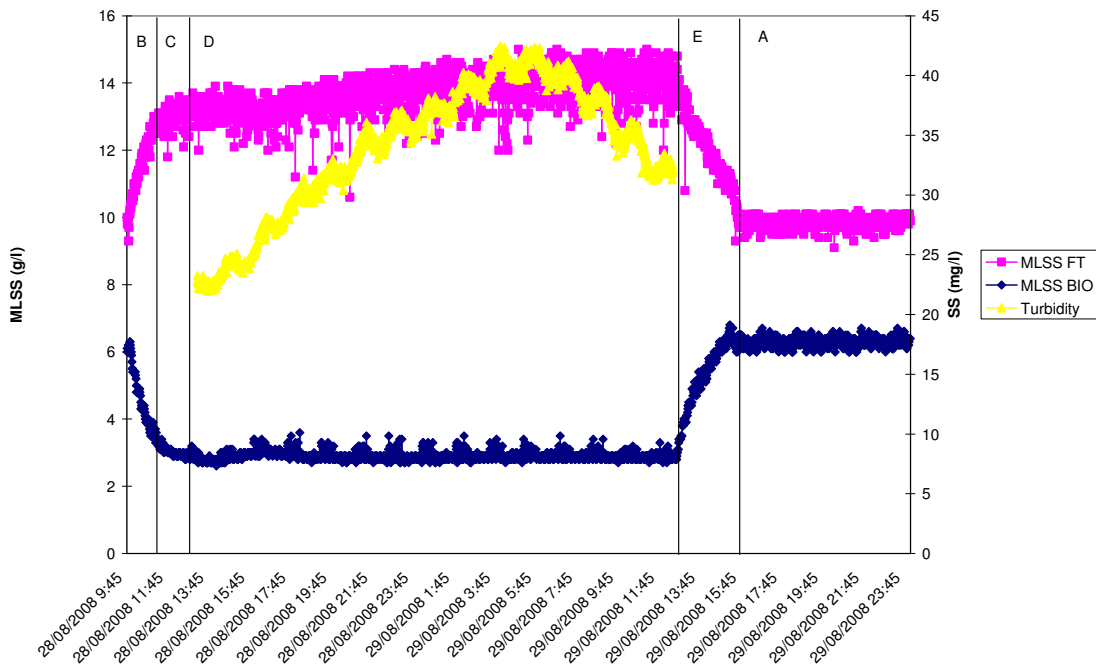

Figure 35. MLSS concentration and resulting effluent turbidity during period 3.

In Period 3, experiments with dynamic flow were performed, switching from dry weather flow (only filtration tank) to rain weather flow (filtration tank and clarifier in parallel). In these

experiments different influent flows were tested. The time between dry weather and rain weather flow ranged from 5 days to 36 days. During these experiments the sludge volume index remained fairly constant. The concentration of effluent suspended solids was dependent on the sludge concentration in the bioreactor. With higher sludge concentration in the bioreactor, a higher sludge blanket was built up in the clarifier. Through the process known as sludge blanket filtration, a lower suspended solids concentration in the effluent was obtained. In most experiments the turbidity of the effluent of the clarifier was acceptable, guaranteeing a combined effluent (from clarifier and filtration tank permeate) with turbidity below the consents. In Figure 35, the MLSS concentration in the bioreactor, filtration tank and the clarifier effluent is shown during a shift in the flow pattern from dry weather flow (DWF) to rain weather flow (RWF) and back.

One should be careful in generalizing these results for two reasons. The relative dimensions of the final clarifier of the pilot plant deviate from the standard design in full scale. Therefore its operation might not be comparable to the operation of a full scale clarifier. Furthermore, the influence of the sludge blanket filtration can not be quantified separately. Consequently these results are insufficient to estimate the effluent quality in the case when no sludge blanket filtration occurs. This research effort has nevertheless been very useful as a preliminary determination of feasibility. Aquafin will continue testing the Dual 2 concept on a larger scale to gain more insight into the design and operational parameters.

8.5 Analysis of plant upgrade with dual MBR technology in EU Associated and Accession Countries

Transposition of the Water Framework Directive into national legislation is a difficult challenge to be tackled by newly accessed EU countries in the coming decade. Actions taken to meet the European standards will implicate thorough changes of the existing wastewater treatment policy and infrastructure in these countries. Adequate refurbishment techniques which combine high quality effluent and a minimal cost can facilitate this process. Hybrid (Dual) forms of conventional activated sludge (CAS) and membrane bioreactor (MBR) technologies yield a high quality effluent and are more cost-efficient than classic MBR technology. The goal of this task is to provide an insight in the economic potential of Dual technologies. First, a detailed description of the status of the wastewater treatment in the different newly accessed EU countries was made (inception stage). Second, a rough assessment of the market potential of different refurbishment scenarios was made (strategic screening stage). Finally, a conceptual design was made for the refurbishment of an existing plant in Veliko Tarnovo, Bulgaria (conceptual design stage).

Inception stage: Overview of typical WWTP in targeted countries

The literature review revealed that MBR technology can be relevant in the following areas, which should be given primary consideration:

- Areas with severe water stress where wastewater treatment is not only envisaged for meeting environmental targets but where it can also serve as an asset to increase the reliability of the water supply through appropriate reclamation and reuse. These areas are mainly the Mediterranean coastal areas and islands, and the coastal areas on the Black sea.
- Wealthier areas with specific geographical properties such as for instance ski resorts, where features such as the seasonal extremes in climate and population, the low footprint for plant upgrading and the cost of the land provide definite competitive advantages to plant upgrading scenarios based on MBR technology. These areas are situated mainly in Slovenia, but also in some developing areas of Slovak republic, Macedonia, Bulgaria, etc
- Sensitive areas to eutrophication in highly urbanised environments (mainly: in the Danube, the Elbe and the Baltic region), and particularly those areas with legislation requirements exceeding those laid down in the EC Directives (e.g. the Baltic states and Cyprus).

Within each of those areas, the plant upgrading potential is very diverse mainly because of the large differences existing from country to country, especially regarding the level of wastewater treatment and the timing of the investment cycles. The dominant technology present in the newly EU accessed countries is activated sludge. Figure 36 and Figure 37 respectively depict the connection rate to sewerage and WWTP infrastructure for each country and the level of treatment. Details on the inception report and on the appropriateness of the MBR technology for the EU Associated and Accession countries can be found in the public deliverable report D55.

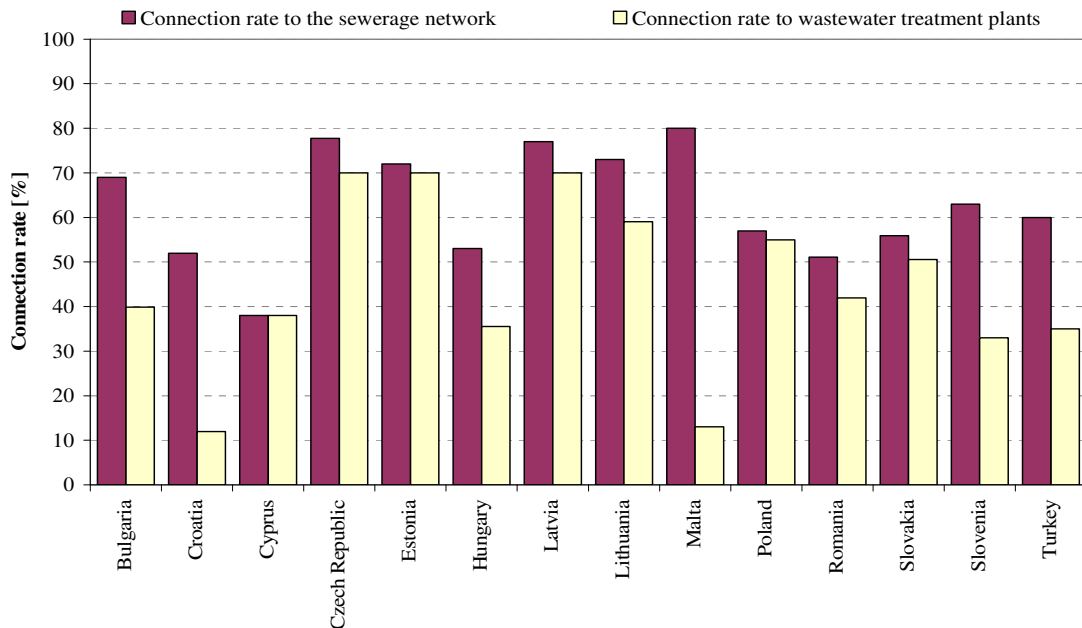

Figure 36. Connection rate to the sewerage network and to WWTPs in the study region

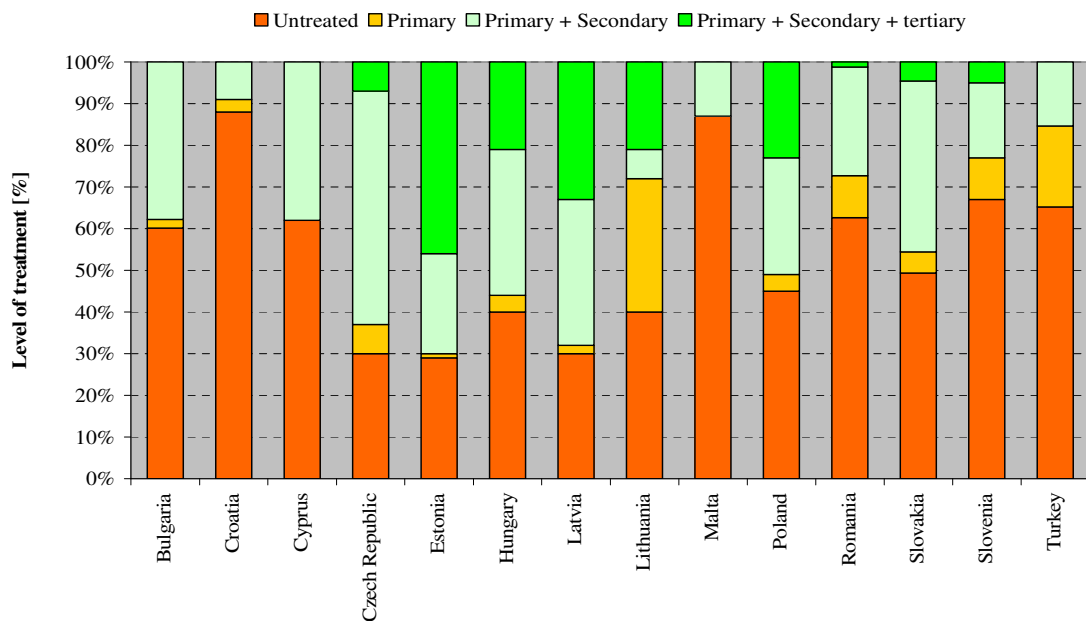

Figure 37. Treatment levels of wastewater collected by sewers in the study region. (Primary treatment: physico-chemical treatment; Secondary treatment: biological treatment without nutrient removal; Tertiary treatment: biological treatment with nutrient removal)

Strategic screening stage: Evaluation of the potential to upgrade 5 typical CAS systems with a CAS/MBR Dual concept in newly accessed countries

Two typical contexts were investigated: the “Bulgarian context” where the treatment goals target only the minimal urban wastewater treatment directive (UWWTD) standards, and the “Cypriot context”, where advanced treatment is thought for appropriate water reuse (Bixio et al., 2008).

In the “Bulgarian context”, the CAS refurbishment scenario was more cost-effective than the MBR scenario's. The cost-comparison between the different scenarios can be found in Figure 38. The net present cost of Dual 1 and Dual 2® refurbishment options were respectively 20 and 25 % higher. Classic MBR retrofitting was found to be 50 % more expensive. The costs are expressed as extra costs per m³ treated in comparison with the status quo scenario.

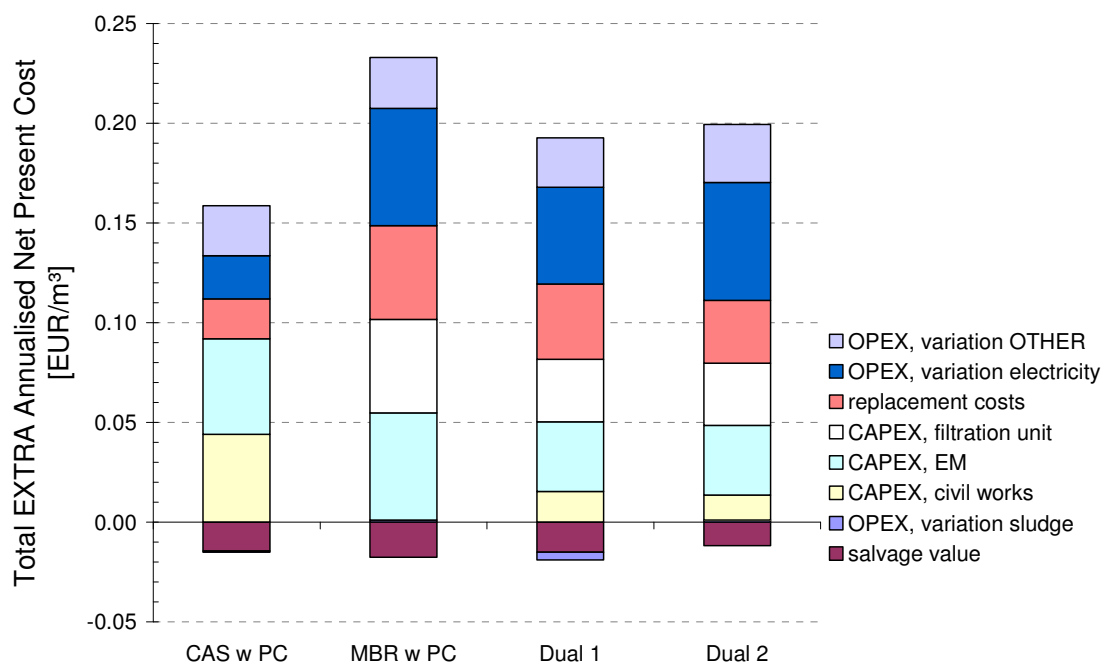

Figure 38. Annualised cost estimates of the main refurbishment options, expressed in EUR per m³: Bulgaria, 11 000 p.e. sensitive area

In the “Cypriot context”, where water reclamation standards have to be met, MBR alternatives become financially more attractive. CAS treatment schemes have to be equipped with tertiary treatment in order to meet the consents (REUSE benchmark scenario). This adds up to the investment costs of a CAS treatment option and renders the MBR scenarios more attractive. As can be seen in Figure 39, the MBR alternatives yield 8 % (classic MBR retrofitting) to 24 % (Dual 2®) less extra costs in comparison to the REUSE benchmark.

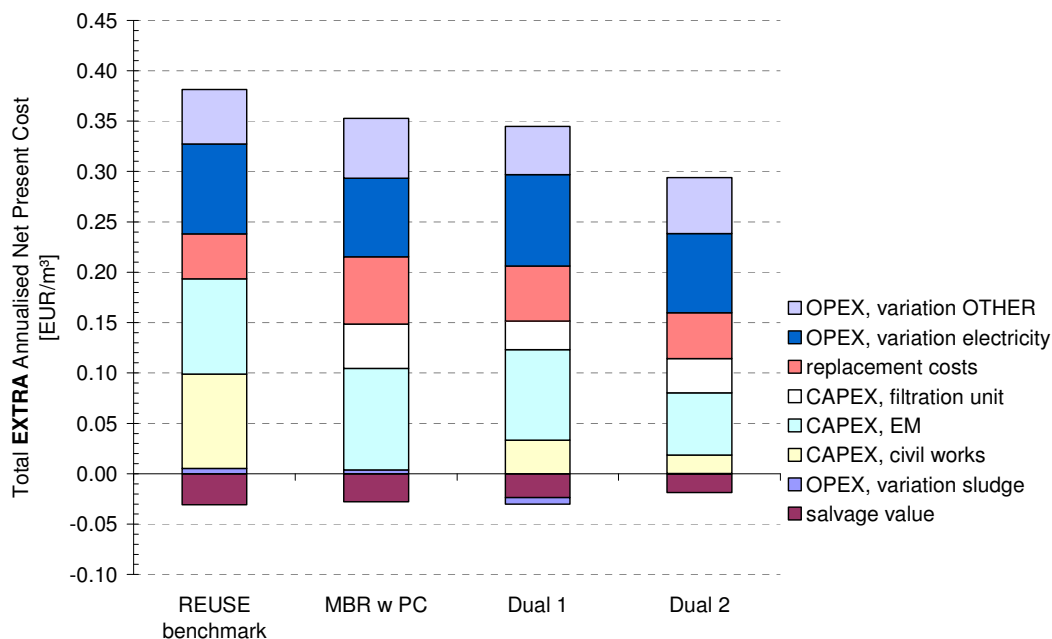

Figure 39. Annualised cost estimates of the main refurbishment options, expressed in EUR per m³: Cyprus, 11 000 p.e. sensitive area

Key determinants at the planning level are the assumptions on the replacement costs, the energy consumption and the economies of scale. Also, the choice of conservative or less conservative parameter values can alter the results significantly. Therefore, the relative costs of these scenarios are strongly case-dependent. Nevertheless, these results reveal an important trend: effluent standards determine the attractiveness of Dual and MBR scenarios.

Conceptual design stage: Scenario-analysis and technical plan for the upgrading of the waste water treatment plant of Veliko Tarnovo, Bulgaria with a CAS-MBR Dual concept

The intention was to perform a technical analysis on a “best case scenario for possible MBR retrofitting of a WWTP”. The high load conventional activated sludge plant of Veliko Tarnovo, Bulgaria (about 120 000 p.e.) was selected. The main drivers for the renovation were an expected influent load increase, together with stricter effluent norms (nitrification / denitrification and dephosphatation). The age of the infrastructure and an inefficient aeration system in the aeration tank can be mentioned as minor drivers. Being located between a river and a railway, the available footprint for construction is however considerably limited, which was perceived as a constraint in favour of the MBR technology.

In the scenario analysis stage, different renovation scenarios were elaborated. In all scenarios, an anaerobic tank was constructed in front of the aeration tank for enhanced biological phosphate removal. The considered scenarios were the following:

- Full conventional activated sludge (CAS) renovation
- Full membrane bioreactor (MBR) renovation
- Dual 1 renovation
- Dual 2® renovation

The volume of the existing aeration tank appeared however to be insufficient to treat the future influent load at sludge concentrations lower than 10 g/L. Consequently, only in the case of a full MBR renovation, no additional aeration tank volume was necessary. The large membrane area required in the full MBR renovation scenario neutralizes this advantage. The

evolution of the cumulative discounted cash-flow is depicted in Figure 40. Both operational and investment costs were included.

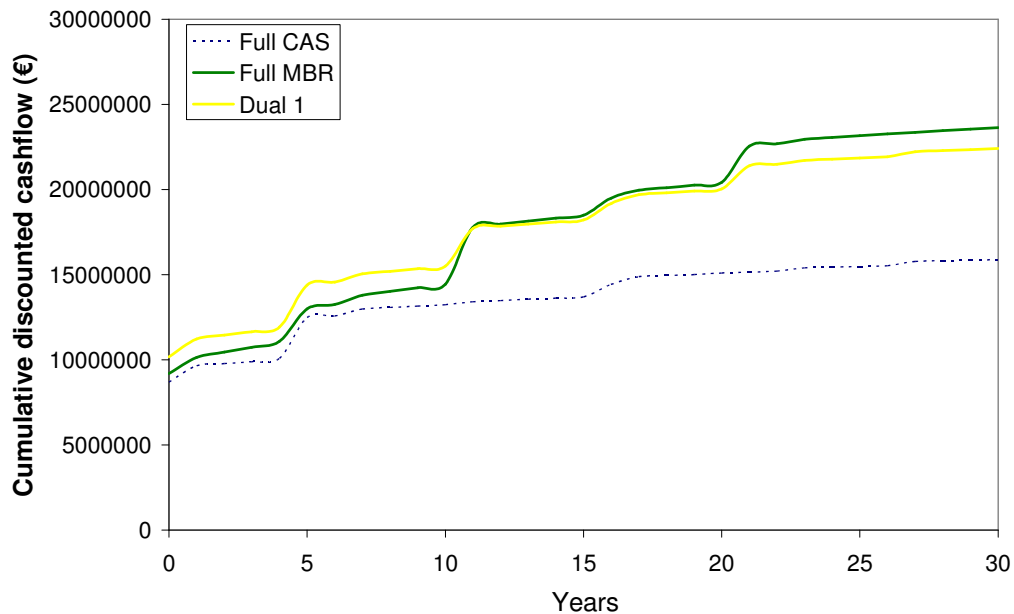

Figure 40. Cost comparison for the renovation scenarios of the Veliko Tarnovo WWTP.
Note: at time of the cost evaluation, the design rules of the Dual 2 concept were not fully defined.

On a lifespan of 30 years, the Full CAS renovation had the lowest cost and the Full MBR renovation the highest. In general, Dual flow schemes are useful for renovations because they do not require extension of the aeration basin which implies a substantial cost saving. This advantage did however not count in Veliko Tarnovo, since the aeration tank had to be extended in the Dual 1 scenario. Besides, the legislative framework in Bulgaria does not require strict effluent standards. Only the minimal urban wastewater treatment directive (UWWTD) standards need to be met. Since Dual technology partly contains MBR technology, which is technologically more complex than CAS technology, certain boundary conditions have to be fulfilled to make it economically feasible. These conditions were not met in the case of Veliko Tarnovo. The full CAS renovation scenario was economically the most feasible and was therefore elaborated in more detail during the conceptual design stage.

This analysis indicates that the main bottleneck for Dual and MBR technology is the cost of the membrane modules. The unit price of membrane modules is still relatively high and considering a lifetime of 10 years, they have to be replaced several times during the lifetime of a treatment plant, a major operation cost as seen in Figure 40.

8.6 Conclusion

The research undertaken by Aquafin has contributed substantially to the available practical knowledge on Dual technology. In the first phase, the effluent quality of the Dual WWTP of Schilde was improved substantially, by redefining the splitting algorithm between the CAS and MBR lane. The experience gained here can also be used in the optimization of other Dual WWTPs. Secondly, research efforts on the innovative Dual 2 concept were performed and this new configuration seems promising. Aquafin will continue testing in the future with a demonstration plant in order to refine the design rules. The relevance of Dual technology was shown in the third phase of this workpackage. The huge efforts to be undertaken in newly

accessed EU countries concerning the upgrading of the existing wastewater infrastructure, create a substantial market for Dual technology. When the right boundary conditions are met, a clean effluent can be provided at a competitive investment cost. More details on these investigations are available in the public deliverable D58.

9 Objective 9. Standardisation of MBR technology.

9.1 Introduction

Today, the European municipal membrane bioreactor (MBR) market is very fragmented and exhibits many membrane characterization methods and MBR filtration products with diverse dimensions, capacities and operational modes. The MBR technology did not undergo a process of standardisation yet, unlike other membrane filtration systems such as nanofiltration or reverse osmosis. Such a standardisation entails increased competitiveness and significant reductions of production cost. In addition, the market of module replacement is expected to be significant in the coming years (see Figure 41), and easily interchangeable MBR filtration modules will be required by the plant operators. The partners of the AMEDEUS project have undertaken an analysis in order to identify the potential and technical possibilities of undergoing a standardisation of the MBR technology in Europe.

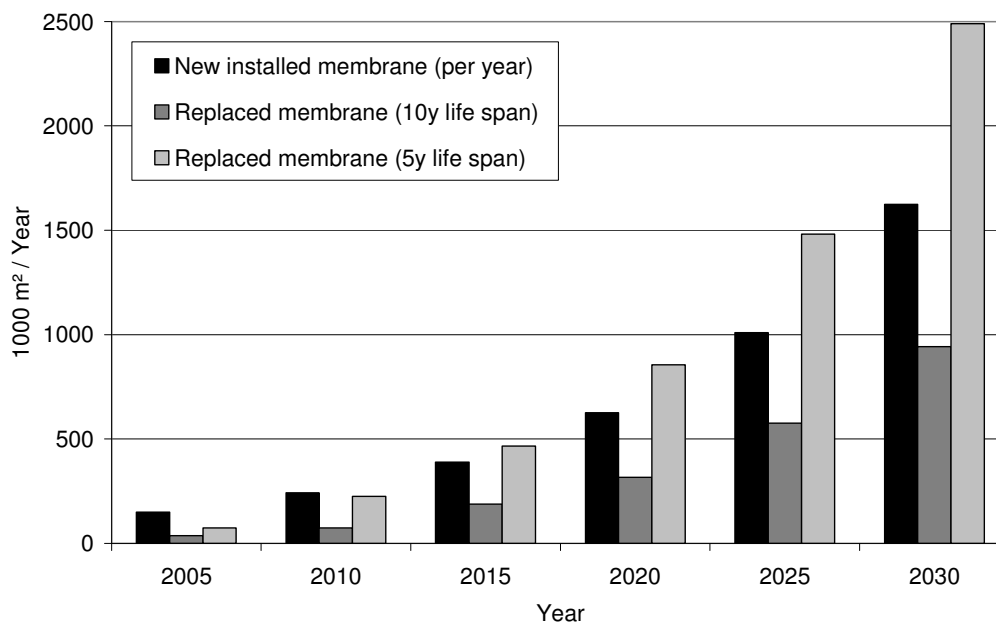

Figure 41. Emerging market of module replacement
Hypotheses: 10% annual growth, 5 or 10 year module life span

9.2 Objectives

Based on an extensive survey of the MBR industry, a comprehensive analysis was performed in the year 2006 on the market interests/expectations and technical potential of going through a standardisation process of MBR technology in Europe. The report of this study, the White Paper (De Wilde et al., 2007), is considered as a public discussion document on MBR standardisation in Europe. It increased awareness and interest in the subject and, according to the outcomes and in agreement with the European MBR industry, initiated a formal procedure of standardisation together with the *Centre Européen de Normalisation* (CEN).

9.3 Materials & Methods

Due to the predominance of submerged filtration systems in municipal applications, the study has focused only on this configuration. Two different aspects of standardisation were considered:

- MBR filtration modules (standardisation towards interchangeable modules in MBRs)
- Characterisation methods for membrane acceptance, fouling, integrity and ageing (standardisation towards uniform quality assessment methods)

An extensive questionnaire on MBR standardisation was sent to the chief players on the European MBR market. These include companies, institutions, research institutes, etc with relevant MBR know-how and experience. In total, 80 companies and institutions active in all areas of the European MBR market were identified after a thorough market review and were individually contacted. The response rate was spectacular and demonstrated the interest of the industry in this initiative: 45 contacts cooperated in this study. The questionnaire inquired about both the market expectations and technical potential of a standardisation effort. After collecting and processing the data, the results were written in a draft version of the White Paper. During an international workshop held in Berlin on 24 November 2006 and hosted by the CEN, this draft version was presented to MBR industry representatives. Their recommendations were added to the final version of the White Paper.

9.4 Results and discussion

9.4.1 Market interests and expectations

MBR filtration modules

The analysis of market interests and expectations for MBR filtration module standardisation indicated that there was a specific interest in guidelines or standards on interchangeable filtration modules in MBRs from both sides of the market. The majority of the MBR operators, constructors, consultants and knowledge institutions were convinced that this is the right time to initiate a process of MBR module standardisation. On the other hand, some of the module suppliers thought that initiating a module standardisation process now would be too early and would hamper the technological innovation in the field. Most market players expected that interchangeable MBR filtration modules would increase the willingness of decision makers to invest in MBR technology and would contribute to a growth of the municipal MBR market - although they did not believe this standardisation process to be one of the top three driving forces.

About twenty potential technological, financial, economical, or environmental advantages/opportunities and disadvantages/threats of MBR filtration module standardisation for suppliers and operators were identified and mapped (Table 16). It appeared that the number of advantages and disadvantages is quite balanced for both sides of the market, the main advantage perceived by the industry being that standardisation should contribute to the growth of the MBR market. Main advantages/opportunities for the end-users are the reduction of dependency on one supplier, price decrease and increased trust and acceptance. Main disadvantages for the module supplier seem to be the higher competition, lower profit margins and a limitation for innovative module producers to enter the market. Main disadvantages/threats for the end-user are over-dimensioning of civil constructions and supplementary works and costs to the peripherals for module replacement.

Membrane characterisation methods

The market players mainly agreed that it is time to initiate a process of standardisation for membrane characterisation tests. The majority of the MBR operators, consultants and knowledge institutions, except the plant constructors, believed that harmonisation of

membrane acceptance tests at module delivery, would probably have a positive impact on municipal MBR market growth. The majority of the respondents felt that standard acceptance tests during plant commissioning could lead to an increase of MBR market growth. Module suppliers were ambiguous about a possible positive impact of standardised tests either at module delivery or during plant commissioning. While several advantages were mentioned, one real concern appeared: the difficulty to find the right methods applicable to all types of membranes.

Table 16. Summary of potential advantages/opportunities and disadvantages/threats for end-users and module suppliers/constructors as a result of MBR filtration module standardisation

	For end-users	For module suppliers or constructors
+ Potential advantages/opportunities	<ul style="list-style-type: none"> • Avoids vendor lock-in (sole source contracts) <ul style="list-style-type: none"> - No technological dead-ends - BAT at all time - Security of supply - Competitive market price guaranteed during re-investments • Price decrease of module • Increased trust and acceptance • Applying standardisation in tendering • Improved comparability of modules • Easier/standardised training of operators 	<ul style="list-style-type: none"> • Bigger market • Applying standardisation in design and construction - cost savings • Reduction of introduction times for new products and services • SMEs may be able to compete (fairly) with large enterprises
- Potential disadvantages/threats	<ul style="list-style-type: none"> • Civil constructions may be over-dimensioned • Supplementary initial costs and works to the peripherals • Process + plant performance might be affected (smaller reliability) • Perhaps more complex legal/guarantee matters 	<ul style="list-style-type: none"> • Increased competition • Lower profit margins • Limitation for innovative module producers to enter the market • Can restrict innovation or affect internal R&D efforts - makes differentiation more difficult

9.4.2 Technical potential

MBR filtration modules

The technical potential for standardisation of MBR filtration modules in Europe was evaluated based on a unique analysis and comparison of nine commercially available MBR filtration modules in Europe, completely different in terms of design and mode of operation. More than thirty technical factors hampering or interfering with a standardisation process were identified, quantified and compared for the surveyed modules, and their relative potential in hampering module-standardisation was evaluated (Table 17). Four factors with a high to extremely high interference are mainly the result of a totally different geometry and dimensions of the filtration module. Discussions for the standardisation of MBR filtration systems should in essence focus on these factors. Sixteen factors with a moderate to high interference are mainly the result of the fact that either a number of products are still in the early development phase of their life cycle, or because they will (drastically) increase total costs of module replacement due to required adaptation works to the peripherals. Sixteen other factors with a low to moderate interference will only be a minor issue, for example because they are part of the common knowledge or practice. It was also revealed that it would be easier and technically wiser to consider two separate standardisation groups: one for flat sheet modules and one for hollow fiber modules.

Table 17. Potential for nuisance of technical factors in a standardisation process towards interchangeable MBR modules (L=low; M=moderate; H=high)

Technical component			Standard(s) common for...			
			flat sheet (FS) modules	hollow fibre (HF) modules	both FS AND HF modules	
Intensive pre-treatment	Screen type		L	M	M	
	Mesh width		L	L	M	
	Redundancy		M	M	M	
	Bypass		L	L	L	
Filtration module	Size		H	H	H	
	Capacity: packing density and design flux		M	H	H	
	Permeate connections	Number		M	M	M
		Diameter		M	M	M
		Type		L	L	L
	Air supply connections	Number		M	M	M
		Diameter		M	M	M
		Type		L	L	L
	Filtration tank	Special provisions manifolds	Permeate	L	L	L
			Sludge	L	L	L
Air			M	L	M	
Dimensions			M	M	H	
MLSS			M	M	M	
Cover			L	L	L	
Peripheral (electromechanical) equipment	Flow rate permeate pump(s)	Gravity filtration	L	M	M	
		Type	L	L	L	
		Reversibility	M	M	M	
	Flow rate sludge feeding / recycling pump(s)		M	M	M	
	Blower(s) coarse bubble aeration	Type		L	L	L
		Flow rate		M	M	H
		Pressure		L	L	L
		Redundancy		L	L	L
	Permeate collection tank		M	L	M	
	Bioreactor	Internal re-screening of sludge		L	L	L
Cover			L	L	L	
Chemical cleaning	Chemical(s)	Kind	L	L	L	
		On-site storage and dosing pumps	M	M	M	
	Heating		L	L	L	
Others	Guarantees	Energy consumption	M	M	M	
		Temperature	L	L	L	
		pH	L	L	L	
	Lifting tackle or crane		M	M	M	
		Total number	19	19	16	
		Total number	16	15	16	
		Total number	1	2	4	

Membrane characterisation methods

End-users and module suppliers were questioned on existing membrane fouling, ageing and deterioration measurements (Table 18). The main operating techniques applied were assessed, and some parameters were identified for integration in a standardisation process. This study emphasized some important parameters for which a common definition and measurement protocol can be helpful. Harmonisation of parameters definition and measurement methods could precede, or accompany the harmonisation of the technologies: this would encourage trust in the technology, and would also reduce the risk of lower quality production. Establishing guidelines and characterisation protocols could be a second step in the standardisation process. The production of such common definitions and characterisation protocols can reply to a real need in the European MBR industry.

Table 18. Summary of main membrane monitoring methods

	Monitoring methods		
	Membrane fouling	Membrane deterioration	Membrane ageing
Main procedures used	TMP Permeability	Visual control Chemical & biological parameters in permeate	TMP Permeability in activated sludge Permeability in clean water
(Additional) requirements/considerations in a standardisation process	Prediction of duration to maintain flux level at specified conditions Monitoring and controlling biological parameters	Turbidity measurement Pressure decay test Integrity indicators Visual control	Membrane surface investigation in laboratory Threshold values for evolution of normalized flux after chemical cleaning and performance after an active cleaning Turbidity

9.4.3 Recommendations by the industry

The outcomes of this study were presented to and discussed with representatives of the European MBR industry at a workshop organised together with the Centre Européen de Normalisation (CEN) in Berlin on 24/11/2006. 35 MBR representatives from 9 countries and 29 different companies accepted the White Paper by plebiscite as a reference document to initiate a procedure of standardisation within the MBR industry. A large majority of the companies argued that their company would be interested one way or another to commit/participate in a process of standardisation of submersed MBR filtration systems (75%) and membrane characterisation methods (90%) in the coming years. The representatives of the MBR industry present at this workshop decided to initiate a standardisation process on submerged MBR technology through a CEN Workshop Agreement (CWA). The CEN Workshop Agreement was published in 2008 (CWA, 2008), document available as framework for public tenders.

9.5 Conclusion

The feedback gathered during this investigation on MBR standardisation indicates the need and concern of the parties involved. The European MBR industry has indicated that the White Paper produced by the AMEDEUS project can be considered as a representative discussion document concerning the standardisation of MBR technology, and further developed a formal CEN Workshop Agreement.

10 Objective 10. Development of novel concepts of MBR filtration modules and systems.

10.1 Introduction

One of the key project objectives was to develop novel concepts of MBR filtration modules and systems that will lead to commercial applications. In order to create a fallback position, the consortium followed three different design approaches proposed by the project partners A3 Water Solutions, Polymem and Inge. The three technologies were assessed and optimised at pilot scale, with the help of technical and economical analysis to identify the weak points and potential improvements.

10.2 Material & Methods

The study was organized in three, successive and identical phases to ensure the development, test and optimisation of three membrane technologies in close collaboration of Anjou Recherche with each of the partner SMEs. Each phase included a first part related to the development of the innovative module concept and the construction of the filtration reactor by the SMEs, immediately followed by a second part related to the evaluation and optimisation of the technology at pilot-scale at Anjou Recherche. The membrane technologies developed and tested were provided by:

- A3 Water Solutions (Microfiltration flat sheet membrane concept - tested from June 2006 to July 2007)
- Polymem (Ultrafiltration hollow fibre membrane concept – tested from July 2007 to April 2008)
- Inge (Microfiltration Fiber Sheet (FiSh®) membrane concept - tested from May 2008 to May 2009)

For the A3 technology, following the promising results obtained at Anjou Recherche, a third phase was added to the initial programme of the project: further tests were performed by A3 Water Solutions facilities to validate the results obtained at Anjou Recherche and undertake further developments.

Pilot platform of Anjou Recherche. To evaluate successively the three technologies, Anjou Recherche, the research centre of Veolia Water, built a flexible pilot platform as shown in Figure 42, which was operated with each MBR filtration technology. The pilot was fed by municipal wastewater from the town of Maisons Laffitte, France, by a pump after screening through a 1mm drum screen. The mean feed water characteristics are given in Table 19.

Table 19. Mean feed water quality

	TSS (mg/l)	COD (mg/l)	TN (mg/l)	TP (mg/l)
Average (Min- Max)	183 (39 -727)	496 (265 -1206)	58 (19-143)	8.9 (5.5 – 20.6)
Sample number	290 samples	331 samples	288 samples	166 samples

The pilot was composed of a biological tank, a membrane tank and a permeate tank as shown in Figure 42. The biological tank was intermittently aerated with fine bubbles and agitated with an impeller to ensure nitrification and denitrification. Mixed liquor was pumped from the biological tank to the membrane tank adapted to each membrane technology. The latter consisted of an aerated tank in which the tested filtration system was immersed. A pump was used to extract the permeate water from the membrane and the permeate water was collected in a storage tank. The concentrated mixed liquor overflowed to the biological tank. The biological operating conditions, typical of MBR systems, were fixed over the entire trials period (Table 20) in order to consider only the influence of the hydraulic operating conditions and membrane characteristics on the filtration performances. The MLSS concentration and the volumetric loading rate were lower when operating with the Polymem membrane because of a lower filtration flow rate compared to the initial design. To obtain a

MLSS concentration in the membrane tank similar to the other trials, the recirculation flow rate was reduced from 5 to 3 times the treated water flow rate.

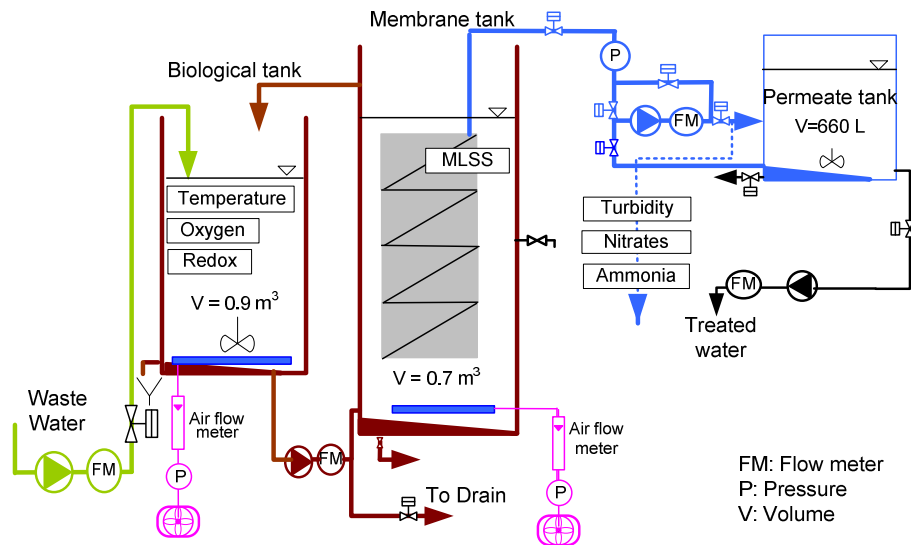

Figure 42. Pilot plant configuration to test novel MBR systems.

Table 20. Mean biological operating conditions

Parameter	Design	A3 Water Solutions	Polymem	Inge
SRT (days)	25	28 (22-32) 200 samples	26 (21 -32) 35 samples	27 (23-36) 69 samples
Volume loading rate (kg COD/m³/d)	1.3	1.36 (0.58-3.09) 185 samples	0.71 (0.30-1.34) 37 samples	1.32 (0.53-2.77) 95 samples
F/ M ratio (kgCOD/kgMLSS/d)	0.13	0.12 (0.06-0.30) 143 samples	0.12 (0.04-0.22) 23 samples	0.13 (0.06-0.31) 44 samples
MLSS (g/L)	9	9.6 (3-17) 210 samples	6.0 (3-10) 43 samples	9.0 (2-14) 74 samples

The hydraulic membrane performances (transmembrane pressure, filtration flow rate, temperature), the quality of the permeate water (ammonia and nitrate concentrations) and the characteristics of the sludge (suspended solids, redox, oxygen concentration) were monitored with a data acquisition system. The permeability and the resistance were calculated using the Darcy's law. The specific air demand per permeate volume unit (SADp) and per membrane area (SADm) were also calculated for each operating condition. Wastewater and permeate water analyses (Total suspended solids (TSS), COD, TN, N-NH₄⁺, pH, etc) were performed on a daily basis to evaluate the treatment performances of the pilot unit, while the mixed liquor characteristics were analyzed on a weekly basis in order to relate any possible membrane fouling to biological stress and / or fouling propensity of the mixed liquor. The parameters monitored for the mixed liquor were mixed liquor suspended solids (MLSS), COD in the supernatant, capillary suction time (CST), viscosity for a shear gradient of 1200s⁻¹, polysaccharides in the supernatant (Dubois method), and proteins in the supernatant (BCA kit).

10.3 Development and evaluation of the A3 technology

10.3.1 Development of the A3 Water Solutions technology

The first technology tested at Anjou Recherche was developed by A3 Water Solutions and was the most mature technology at the start of the project. The concept is based on a block of micro filtration flat sheet. A PVDF membrane was chosen and used for the tests carried

out at Anjou Recherche. The module is built with multiple filtration plates arranged in parallel with defined spaces between every single plate. The membrane cushions are fixed by moulded sides, in which the filtrate is collected as shown in

Figure 43. The A3 Water solutions modules can easily be stacked on top of each other: A3 designed a 'multi module' consisting of 6 (double deck) up to 9 (triple deck) modules. Improvements of the module housing were carried out during the project following the results gathered in Anjou Recherche.

For this technology, filtration occurs from outside to inside of the plates. To ensure maximum filtration efficiency, an aeration ramp with medium-size bubbles is installed below the filtration modules. The resulting turbulence in the gas-liquid mixture ascending through the spaces between the individual membrane plates enables to detach the filtration cake deposits. Research work was in particular carried out by A3 to improve the aeration distribution under the modules. The filtration process operates normally in the so-called filtration/pause mode. A backwash procedure was nevertheless developed for this flat sheet technology during the project.

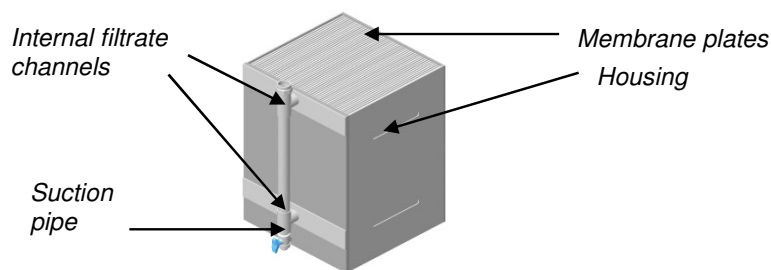

Figure 43. A3 Water Solution MBR module concept

10.3.2 Evaluation of the A3 Water Solutions technology at pilot-scale

For the evaluation study at Anjou Recherche, two modules in double-deck configuration were immersed in the membrane tank and stacked as double deck (2x 70 m²).

Treatment performances. During the trials, the biological treatment was according to the expectations in MBR: the COD concentration in the effluent was on average 16.7 mg/l and always less than 70 mg/l, the total suspended solids were totally removed with a very low turbidity in the treated water (<0.1 NTU). The number of total coliforms in the permeate water was on average 7.4 pro 100ml and varied from 0 to 32 pro 100ml. The presence of coliforms detected in some permeate samples can be related to the difficulty to sample the permeate in sterile conditions.

Membrane Performances. The trials showed that the filtration design was well adapted to MBR application and the filtration operating conditions could be optimised during the trials. The development of a new operation mode including the use of a double-deck configuration and specific backwashes for flat sheet membranes enabled to achieve an improved membrane performance for the A3 Water Solutions technology. The double-deck configuration does not impact the fouling behaviour and reduced the air demand per membrane surface unit. It was shown that the double-deck system could operate in a pilot plant under typical biological operating conditions (MLSS = 10 g/l, SRT = 28 d, F/M = 0.12 kgCOD.kgMLSS⁻¹.d⁻¹) at a net flux of 25 L.h⁻¹.m² when using filtration/relaxation cycles of 8min/ 2min, specific backwashes and maintenance cleanings with a SADm as low as 0.2 Nm³.h⁻¹.m². This corresponds to a SADp of 8 Nm³ air/m³ permeate, lower than the ones reported for current membrane systems for pilot or full-scale plants (Figure 44).

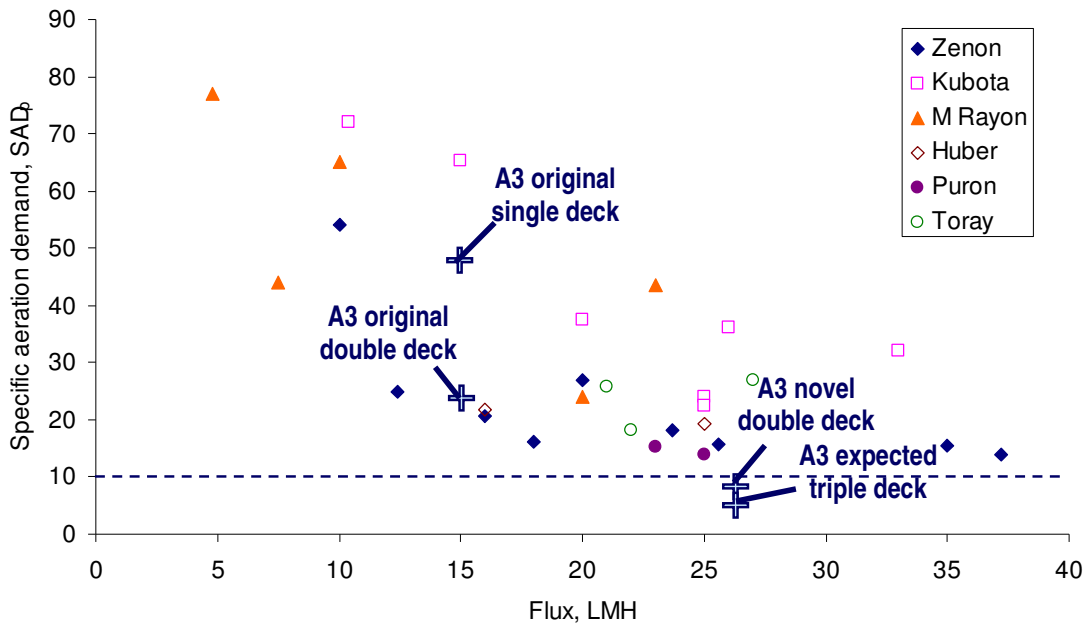

Figure 44. SADp of full-scale plants for current market technologies (adapted from Judd, 2007) and comparison with the assessment of the A3 technology in the project.

The fouling behaviour of the system was then studied when performing peak flows and increasing the MLSS concentration in the membrane tank. The pilot plant, still operating with a net flux of $25 \text{ L}\cdot\text{h}^{-1}\cdot\text{m}^{-2}$, a SADm of $0.2 \text{ Nm}^3\cdot\text{h}^{-1}\cdot\text{m}^{-2}$ and peak flows (equal to 1.5 times the net flux of $25 \text{ L}\cdot\text{h}^{-1}\cdot\text{m}^{-2}$, keeping a SADm of $0.2 \text{ Nm}^3\cdot\text{h}^{-1}\cdot\text{m}^{-2}$) were programmed to occur twice a day during two hours. One backwash was carried out after one of the peak flows. A decrease of the permeability was observed during the peak flows (Figure 45) but the permeability recovered to its original value during the period with lower flux. No loss of the membrane permeability over time was observed at the beginning of the peak flow tests until a sludge foaming event occurred which led to a permeability drop. The use of backwash and maintenance cleanings avoided a rapid fouling, although the peak flows still occurred, and then enabled the recovery and stabilisation of the permeability when the quality of the mixed liquor quality improved. The established hydraulic operating conditions enabled therefore to cope with the fouling due to foaming event and the peak flows, as long as MLSS in the membrane tank was kept below 18 g/L (see tests with MLSS up to 25 g/L at the end of the trials).

The quality of the sludge appeared to influence greatly the membrane performance but no correlations appeared between the mixed liquor characteristics and the fouling rates. A robust system and durable operation conditions are therefore essential to cope with unexpected events.

Details on this investigation can be found in the public deliverable report D19 "Evaluation of the A3 technology".

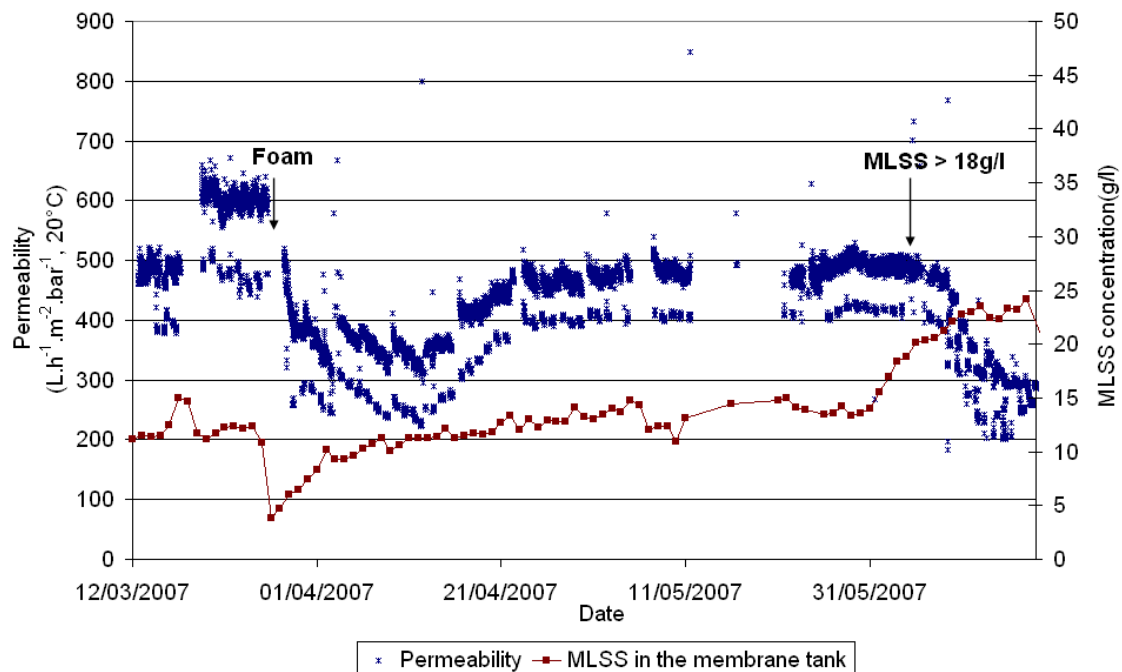

Figure 45. A3 membrane performances with peak flows and an increase of the MLSS concentration in the membrane tank

10.3.3 Evaluation of the operation strategy at full-scale and further developments

Evaluation in full scale plants. The validation of the cleaning strategy assessed in the facility of Anjou Recherche was performed with a pilot plant at the test side of ISA Aachen and with the full scale MBR plant of Xanten, Germany (2,000 pe). The trials were conducted with filtration cycles of 8 minutes and 2 minutes relaxation, and specific backwashes combined with maintenance cleanings. NaOCl was used as cleaning agent in a solution with 200 ppm and a residence time of 20 minutes. The pilot plant was equipped with microfiltration modules (M70 002) in double-deck configuration. The plant was supplied with pretreated wastewater from the WWTP Aachen. The SADm was adjusted in a range between 0.2 and 0.25 Nm³/(h.m²). Under these operating conditions a stable flux of 30 L/m².h could be achieved. The same operation strategy was then assessed in the MBR plant of Xanten WWTP. The MBR in Xanten is designed with two parallel lines, each equipped with 16 microfiltration modules (M 70) in double-deck configuration. The total membrane area amounts to 2,200 m². During the trials, the MLSS was about constant with 11.5 mg/l. By using specific backwashes and maintenance cleanings it was possible to increase the period of filtration between two recovery cleanings.

Engineering and test of triple-deck configuration. The development of the A3 triple-deck configuration and the concept resulted from positive experiences with the application of the double-deck in order to develop possible designs with multi modules (3, 6, 9, and 12 modules, i.e. 210 m², 420 m², 630 m² and 940 m²).

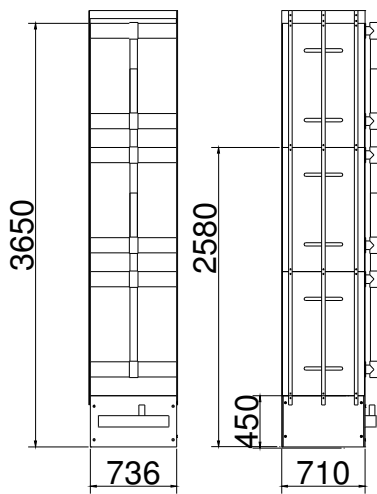

Figure 46. Design of the A3 triple deck module



Figure 47. Installation of the A3 triple deck module in the pilot plant of Seelscheid WWTP

Figure 46 shows a technical drawing of the triple-deck module. With the aeration system the height amounts 3.65 m, fitting in basins of about 4.5m. Figure 47 shows the installation of a triple-deck module in a pilot plant set up at Seelscheid WWTP demonstration site, Germany. Stable filtration performances were achieved with a net flux of up to 25 L/h/m². The SADm was set at 0.23 Nm³/(h.m²) with 8min/2min filtration and relaxation cycles (MLSS in the range of 8 – 12 mg/L). This confirmed the good filtration performances of the triple deck module, with similar flux achieved than with the double-deck module. A further installation of a triple-deck module was installed in one MBR unit at Pongs GmbH for treatment of industrial waste water from improvement of textile materials and was operated since without any trouble.

Engineering of “Module M90X”

The current modules manufactured by A3 feature 70 m² for a dimension of about 700x710 mm. The development of the “Modules M90X” consisted in designing a larger module of a length of about 1m, keeping a regular gap of 7mm between the sheets to prevent clogging. Such modules of about 91 m² would lead to more compact filtration systems and lower production costs. An engineering drawing of an “Module M90X” is shown in Figure 48.

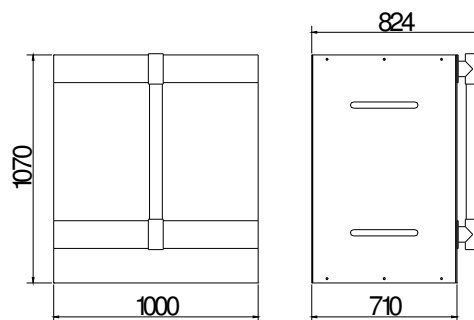

Figure 48. Design of Module M90X

10.4 Development and evaluation of the Polymem technology

10.4.1 Development of the Polymem technology

Polymem developed during the project a new module concept for MBR application, based on hollow fibres polysulfone ultrafiltration membranes. The fibre configuration was purposely chosen without textile reinforced braid for two reasons: the low price of the fibre and the possibility of working with small fibre diameters (1.47mm) leading to higher packing densities. Different bundle configurations were first investigated by Polymem by performing hydraulic tests. Bundles consisting of hollow fibres with a diameter of 1.47mm (fibres M) having a surface area of 2.48 m² and a packing density of 54% (m² of fibres section / m² of bundle section) were first chosen for the Polymem technology.

The new Polymem module consisted of bundles of hollow fibres arranged and packed in a carter as shown in Figure 49. This module configuration facilitated the verification of the membrane integrity and the repair of damaged hollow fibres. The membrane aeration was in addition well channelled. Filtration was achieved from the outside to the inside of the hollow fibres.



Figure 49. Polymem module photos (side and top views)

10.4.2 Validation and optimisation of the Polymem bundles configuration

For the study at Anjou Recherche, a first module was tested in 2008. Following the results, complementary tests on the bundles configurations were carried out before performing a final evaluation of the chosen configuration in 2009.

Treatment performances. The biological treatment was according to the expectations in MBR when the membrane integrity was good: the COD concentration in the effluent was always less than 22 mg/l, the total suspended solids were totally removed with a very low turbidity in the treated water (<0.1 NTU).

First Polymem module. The first tested module consisted of 18 bundles of 2.78 m² (50 m² of total surface area) with a packing density of 54% (m² of fibres section / m² of bundle section). The chosen packing density was relatively high, in agreement with the objective of capital investment costs savings.

This module was tested from August to September 2007 at Anjou Recherche. Several problems occurred during this period:

- a clogging of the bundles occurred because of a too high packing density and a bad penetration of air scouring inside the bundles when operating at a net flux less than 10 L.h⁻¹.m⁻².
- the fibres were subject to breakages on the edge of the pottings when the bundles were clogged.

Following these results, Polymem looked for new bundle configurations more adapted to the filtration of high suspended solids concentration by performing cleaning tests with the previous clogged bundles by removing progressively fibres from the bundles. Following these tests results, three bundle configurations were selected for further tests at Anjou Recherche.

Selection of new bundles configuration. Different bundles types were implemented in the module from January to February 2009 at Anjou Recherche. Typically, 3 different bundles types with different packing densities and hollow fibres diameters were tested (Table 21).

Table 21. Bundles configurations implemented in the module

Bundles	Type 1	Type 2	Type 3
Fibre diameter (mm)	1.47 (Fibres M)	1.47 (Fibres M)	2.38 (Fibres L)
Membrane surface (m ²)	1.82	0.99	1.51
Bundle density (%)	35	19	48

To evaluate the performances of each bundle configuration, the bundles were removed from the module every 2 weeks. Permeability measurements were performed on each bundle and the clogging evolution was observed. Moreover, the number of hollow fibre breakage was counted for each bundle types. The results are summarised in Table 4. The bundles of fibres M (diameter of 1.47mm) with a packing density of 19% were not clogged but were subject to fibre breakages. The bundles of fibres L with a packing density of 48% did not break but clogged after 2 months operation. These bundles were selected for a final evolution of the Polymem technology in particular because they were more resistant than the others.

Table 22. Summary of the results

Permeability evolution:	Clogging degree:	Number of broken fibres:
Fibres M- 35% = Fibres M-19% = Fibres L 48%	Fibres M-19% < Fibres L 48% < Fibres M- 35%	Fibres L 48% < Fibres M- 35% = Fibres M-19%

Final Polymem module. The last Polymem module configuration therefore consisted of 18 bundles of fibres L (diameter of 2.38 mm) with a packing density of 48%. The membrane surface of each bundle was of 1.51 m². In total, the module had 27 m² of membrane. This module operated during around one month. The system first operated with: 10 min filtration / 1 min relaxation / 30s backwash, an instantaneous filtration flux of 10 L.h⁻¹.m⁻² (20°C), a backwash flow rate of about 22 L.h⁻¹.m⁻² and a continuous aeration of 8 Nm³.h⁻¹. The filtration flux was then increased to 12 L.h⁻¹.m⁻² which appeared as the maximum operating flux for sustainable operation. Sequenced aeration was then carried out but did not appear very useful to control the fouling behaviour of the system. Furthermore, results showed that the bundle configuration and aeration system design was not yet optimal leading to sludge accumulation inside the bundles. Further developments are therefore required to optimise the module configuration before optimising the hydraulic operating conditions. It was nevertheless confirmed that fibres L were more suitable than fibres M because no fibres breakage occurred during the operating time of this final module. But further tests are still required to verify their reliability during longer time.

10.5 Development and evaluation of the inge technology

10.5.1 Development of inge technology

Inge AG developed a process to manufacture a new membrane concept called FiSh® (Fibre Sheet) which consists of a multitubular membrane sheet made in polyethersulfone as shown in Figure 50.



Figure 50. inge multitubular sheets

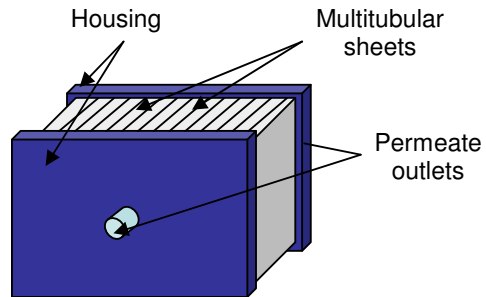

Figure 51. inge module

Membranes were spun on a purpose-made membrane spinning machine, capable of producing fibre sheet membranes up to 40 cm in width. The inge sheets are manufactured in a single extrusion step, eliminating the need for gluing, and are only supported by the module housing. As this is a completely novel type of membrane geometry, all the membrane production parameters were investigated, in order to achieve good pore size control and overall acceptable performance.

Over the entire period of the programme, the membranes were modified to adjust some parameters in order to overcome difficulties in the testing phases at Anjou Recherche. Especially the issue of membrane flexibility has come up several times, and many spinning runs were necessary to improve this feature. Other important membrane characteristics like hydrophilicity and pore size (inside and outside), were gradually improved. Some membrane shape irregularities appeared when the porosity of the membrane increased, or when the wall thickness increased. It was minimised by varying some of the spinning parameters, but it could not be fully eliminated for the microfiltration membranes provided for testing. The mean pore size of the produced membrane for Anjou Recherche was 0.2 μ m.



Figure 52. lab scale FiSh manufacturing facility

The membrane sheets were then fixed by moulded sides (Figure 51). The obtained modules can easily be stacked on top of each other. Filtration occurs from the outside towards the inside of the sheets as for usual flat sheet membranes and permeate water is collected into the multitubes disposed horizontally. These sheets contrary to usual flat sheet membranes support the use of backwash which can be used to prevent clogging. To ensure maximum filtration and cleaning efficiency, an aeration system is also installed below the filtration module stack.

This new inge Fibre Sheet (FiSh®) technology combines therefore the advantages of:

- flat sheet systems in terms of (i) easy control of fluid distribution through the flat sheet network and (ii) having the possibility of stacking modules;
- hollow fibres systems in terms of (i) fouling control during operation (the membrane can be backwashed), (ii) mobility of the multitubular sheets in comparison with the usual flat sheet membranes in presence of aeration and (iii) membrane packing density.

10.5.2 Validation and evaluation of the inge technology

For the trials at Anjou Recherche, four modules were stacked on top of each other. Three inge modules generation were successively tested during the trials

Treatment performances. The removal of organic carbon and solids in suspension was according to the expectations in MBR when no membrane damages occurred: the COD concentration in the effluent was on average 15 mg/l (always less than 28 mg/l), the total suspended solids were totally removed with a very low turbidity in the treated water (<0.1 NTU). The average total nitrogen concentration was of 13 mg/l (removal of 75%) thanks to a good aeration regulation.

First inge module performances. The first inge modules consisted of 25 parallel sheets evenly distributed. Several membrane breakages close to the membrane potting occurred during the first trials because of high strength on the membrane close to the potting. With the first modules, no stable hydraulic operating conditions were found probably because of sludge accumulation into the fibres when breakages occurred during operation. The modules were therefore changed by new ones having a different potting.

Second inge module performances. With these new modules, fewer membrane breakages occurred during operation: a first breakage appeared after few weeks of operation. This was repaired and the next important damages further occurred after another 1.5 month operation. Short term experiments of 1h were carried out first at a net flux of 25 L.hr⁻¹.m⁻² to identify the most adapted filtration operating conditions for this new membrane technology by varying the filtration time, the relaxation time, the backwash time, the backwash flux and the membrane aeration flow rate. The aeration flow rates were chosen in order to have SADm values less than 0.6 Nm³.hr⁻¹.m⁻² and SADp values less than 25 Nm³_{air}/m³_{permeate} which are in accordance with the values given for current membrane systems (SADm = 0.2-0.8 Nm³.hr⁻¹.m⁻² and SADp = 8-25 Nm³_{air}/m³_{permeate}, see Figure 44). Six short-term experiments showed a low resistance increase inferior to 0.01x10¹² m⁻¹.hr⁻¹ indicating good fouling control. To verify the efficiency of these operating conditions, longer experiments lasting 1 to 2 days were performed. The last tested experiment conditions (6 min of filtration followed by 22s of backwash at 130 L.h⁻¹.m⁻²; net flux= 25 L.hr⁻¹.m⁻²; SADm = 0.36 Nm³.hr⁻¹.m⁻²) appeared promising as stable permeability could be achieved. However, membrane breakage occurred after several hours of operation under these conditions and the tests were stopped. New modules were then developed by inge.

Third inge modules. Following previous results, inge still improved their module configuration: the membrane mechanical resistance was increased, a new potting was developed, end-caps were added to facilitate the reparation of the damage sheets and the number of plates for one module was increased to 35 plates. To test these new modules, only operation with backwash was considered as it appeared during the previous tests that the use of backwash could be promising. The filtration parameters were fixed at a filtration time of 6min followed by 30s of backwash at a flux twice the filtration flux (lower than previously), leading to a SADm of 0.4 Nm³.h⁻¹.m⁻².

A first membrane breakage occurred after few weeks of operation leading to sludge accumulation into the module which was therefore removed from the pilot. A new integrity problem occurred then after 3.5 months operation and at the end of the trials when performing crash test (using high backwash flux). These modules of third generation appeared however much more resistant than the previous ones.

The membrane performances of the last inge modules were satisfying: they could operate several weeks at a net flux of 20 L.h⁻¹.m⁻² for a SADm of 0.4 Nm³.h⁻¹.m⁻² (with 3 modules, Figure 53) which is close to the performance of current commercial membrane systems. Operation at a net flux of 25 L.h⁻¹.m⁻² seemed however to be critical as it led twice to severe permeability drops.

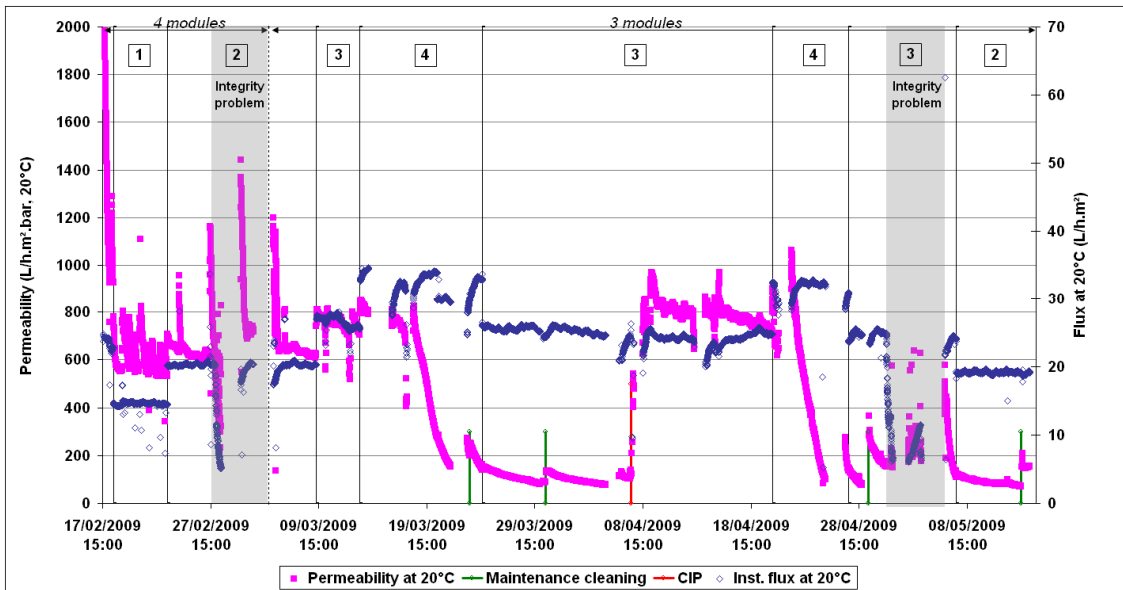

Figure 53. Resistance and flux evolution for selected operating conditions

(1: Jn = 10 L.h⁻¹.m⁻², 20°C with backwash of 30s at 26 L.h⁻¹.m⁻²; 2: Jn = 15 L.h⁻¹.m⁻², 20°C with backwash of 30s at 39 L.h⁻¹.m⁻²; 3: Jn = 20 L.h⁻¹.m⁻², 20°C with backwash of 30s at 52 L.h⁻¹.m⁻²; 4: Jn = 25 L.h⁻¹.m⁻², 20°C with backwash of 30s at 65 L.h⁻¹.m⁻²)

Further membrane and module developments are still required to avoid membrane breakages close to the potting but also sludge accumulation at the membrane surface. Indeed, visual observations of the membrane also showed that irregularities present at the membrane surface led to sludge accumulation in some areas for all module generations. Without these irregularities, better membrane performances with a better use of the membrane surface are expected.

10.6 Conclusions

The objectives of the study were on one hand to develop and validate the configuration of 3 membrane systems (developed by A3 Water Solutions, Polymem and inge) and on the other hand to optimise the hydraulic operating conditions under typical biological operating conditions (MLSS= 10g/l; F/M= 0.13 kg COD/kgMLSS/D; SRT= 25d). The flat sheet technology of A3 Water Solutions was already developed since several years at the start of the project whereas Polymem and inge developed new filtration system concepts during the project: respectively a carterised hollow fibre module and a Fibre Sheet module.

The A3 filtration system which was the more mature technology was well adapted for operation in MBR application because no membrane breakage occurred during operation and no important clogging was noticed during the trials. Double-deck configurations do not

impact the fouling behaviour and enable important decrease of the air demand per membrane surface unit (SADm). On the contrary, the technologies of Polymem and Inge, which were completely new filtration systems, require further development before possible commercialisation. Their first drawback is linked to the membrane mechanical resistance: several problems with membrane breakage occurred leading to contamination of the permeate. The second fibres (with a larger diameter) supplied by Polymem appeared more adapted to the MBR applications but need to be longer tested. The packing density of the tested bundles was also too high, leading to irreversible entrapment of the sludge into the bundles. Such clogging was avoided with the Inge membrane but it appeared that the membrane surface was too rough (with the presence of membrane irregularities) leading to some sludge deposit. Moreover, the aeration design of both systems was not optimised.

For the A3 membrane, the hydraulic operating conditions could be optimised. Satisfying and reliable fouling control was achieved with this system when operating with backwashes and maintenance cleanings at a net flux of $25 \text{ L}\cdot\text{h}^{-1}\cdot\text{m}^{-2}$ (20°C) and under a low SADm value of $0.2 \text{ Nm}^3\cdot\text{h}^{-1}\cdot\text{m}^{-2}$ (corresponding to $8 \text{ Nm}^3/\text{m}^3_{\text{permeate}}$, competitive with current commercial MBR systems). Hydraulic operating conditions were not optimised with the Polymem system because of important membrane clogging. Finally, the last module generation supplied by Inge could be operated at a net flux of $20 \text{ L}\cdot\text{h}^{-1}\cdot\text{m}^{-2}$ for a relatively low SADm of $0.4 \text{ Nm}^3\cdot\text{h}^{-1}\cdot\text{m}^{-2}$ which is promising knowing that the module configuration is still sub-optimal due to the sludge accumulation at the membrane surface.

11 Objective 11. Development of MBR modules with textile filtration media.

11.1 Introduction

Membranes used in MBR process are generally microfiltration membrane (MF) or ultrafiltration membrane (UF). The membrane materials commercially used in MBR processes include both unmodified and surface modified polymeric materials, such as polyethylene, polypropylene and polysulfone and to a lesser extent ceramics. The pore sizes of these membrane materials are usually in the $0.02\mu\text{m}\sim 0.5\mu\text{m}$ range. Novel textile filtration media in the sub-micron may be an economical option compared with polymeric micro- or ultrafiltration membranes, due to the lower cost per unit of surface (production costs per square meter 5 to 50 times lower than those of organic micro- or ultra-filtration membranes, i.e. $<2\text{€}/\text{m}^2$ instead of 10 to $40\text{€}/\text{m}^2$) and the potentially greater filtration flux, which would lead to less aeration requirement. This would be particularly interesting for applications where the high hygienic standard of an MBR is not necessary.

Non-woven fabric materials are extensively used for the removal of particles larger than $1\mu\text{m}$ in decontamination process, especially in air filtration. Non-woven fabric materials are composed of random networks of overlapping fibers. They can create multiply connected pores through which the fluid can flow. Non-woven fabric filtration material has many outstanding properties, such as controllable pore size distribution and easy design of fiber surface area per unit weight and volume. Both woven (Fuchs et al. 2005) and non woven (Chang et al. 2007) textiles were recently applied in lab studies as a filter material for MBR applications, but the research is at an early stage and so far textiles are not commercially available for MBR. In fact, these studies showed that the effluent permeated from the nonwoven bioreactor and hollow fibre membrane MBR, showed little difference, at the exception of the disinfection performances. However internal fouling, induced by large pore size, mainly affected the performance of textile membranes. The development and evaluation of an appropriate and surface modified textile for MBR applications was an objective of the AMEDEUS project.

In the first year of the project, 18 nonwoven membranes (10 commercial membranes and 8 newly produced membranes) were characterised in terms of chemical and physical properties. It was found that even if nonwoven textiles can ensure suitable performance in terms of chemical and mechanical resistances and in terms of permeability, they show some limitations in filtration tests performed over a period of 12 hours only because of the high fouling induced by their rough surface and their large porosity (Iversen et al. 2007a).

In order to overcome these limitations two different approaches were investigated:

1. the deposition of a nanofiber layer onto conventional nonwoven
2. the use of flocculants to increase the floc size and facilitate the sieving.

11.2 Deposition of nanofiber onto conventional membranes

Nanofibers are defined as fibers having a diameter of less than one micron. Generally, polymer nanofibers are produced by electrospinning process. This technique allows to produce polymer filaments using electrostatic forces. In the electrospinning process, a high voltage is used to create an electrically charged jet of polymer solution or melt, which dries or solidifies to leave a polymer fiber. One electrode is placed into the spinning solution/melt and the other attached to a collector. An electric field is subjected to the end of a capillary tube that contains the polymer fluid held by its surface tension. This induces a charge on the surface of the liquid. Mutual charge repulsion causes a force directly opposite to the surface tension. As the intensity of the electric field is increased, the hemispherical surface of the fluid at the tip of the capillary tube elongates to form a conical shape, known as the Taylor cone. With increasing field, a critical value is attained when the repulsive electrostatic force overcomes the surface tension and a charged jet of fluid is ejected from the tip of the Taylor cone. The discharged polymer solution jet undergoes a whipping process wherein the solvent evaporates, leaving behind a charged polymer fibre, which lays itself randomly on a grounded collecting metal screen. In order to spin nanofibers onto conventional textile supports an electrospinning prototype was designed and constructed by Tecnotessile - TTX (Figure 54).

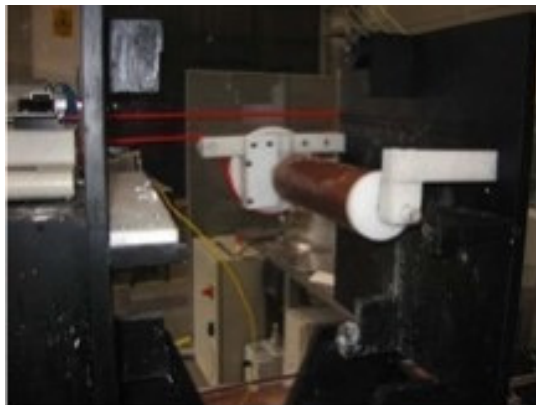

Figure 54. Picture of the electrospinning prototype designed and constructed by TTX

Different polymers (Nylon 6; Polyethylene Oxide; PolyethyleneEthyl Keton; PolyCarbonate) were investigated and electrospun onto three different conventional nonwoven membranes – FF2007 Polypropylene nonwoven; Novatexx 2431N Polyester nonwoven; Novatexx 2471 Polypropylene nonwoven provided by Freudenberg – selected according to their processability in the A3 production line with minor modifications in cushion and potting of the membrane to the module structure. The most suitable polymers were Nylon 6 (NY6) and PolyCarbonated (PC). The production parameters optimised for both polymers are listed in Table 23.

Table 23. Treatment optimal conditions for the production of nanofibers

Parameter	Nylon 6	PolyCarbonate
Polymer concentration [%wt.]	18	14
Voltage [kV]	30	50
Flow Rate [ml/min]	0.25	0.15
Distance Electrode [cm]	9	17

Nanofibers of a diameter in the range of 200-250 nm and 150–200 nm were produced by applying these conditions for NY6 and PC respectively and a homogeneous cover of the surface has been achieved (Figure 55). The layer thickness is around 12 – 18 μm .

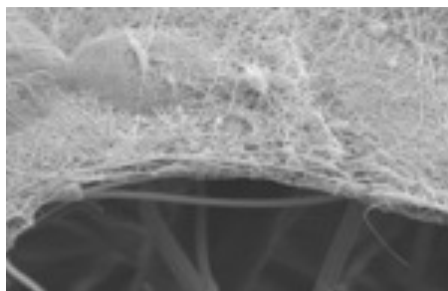
**Figure 55. SEM picture of the NY6 nanocomposite membranes.**

Since the production of the PC nanofiber was just optimised at the end of the project, the NY6 nanocomposite membrane was fully investigated for the production of a Textile Bioreactor. In fact, physical characterisation and preliminary filtration tests suggested that the nanocomposite is a very promising substrate (**Table 24**): similar characteristics and performance of the conventional MF PVDF membrane currently used by A3 for the production of MBR module could be achieved.

Table 24. Main characteristics and performance of the NY6 nanocomposite textile membrane compared with conventional one

Parameter	Nanocomposite membrane	PVDF membrane
Roughness ¹ [μm]	1.5 – 2.5	1.5 – 3.3
Pore Size ² [μm]	0.6 – 0.8	0.3
Tensile strength ³ [MPa]	15-25 MPa	21 MPa
Biofilm Growth ⁴ [%]	0.9 -1.0	0.6 – 1.0
Time TMP ⁵ = constant	> 12 h	> 12 h
Critical flux ⁶ [L/h.m ²]	35 (sludge) 170 (flocculated sludge)	37 (sludge) 54 (flocculated sludge)

¹assessed by using a scanning topography measurement instrument (Altisurf 500)

²performed by means of Capillary Flow Porometry

³performed according to Standard Test ASTM D638

⁴weight increase after exposure to 0.5 g/L yeast suspension at 33°C for 48 h.

⁵constant pressure conditions of approx. 0.6 – 0.65 bar

⁶determined with the flux-step method similar to Koseoglu et al. (2008) with 7 min filtration and 2 min relaxation.

In order to improve the permeability of the membranes and to ensure better anti-fouling behaviour of the membrane, functionalisation of the nanofibrous layer by means of Dielectrical Barrier Discharge Atmospheric Plasma was performed: active species generated by Nitrogen Plasma were used to graft hydrophilic and hydrophobic precursors (a total of 6 chemicals - Acrylic Acid, Vinyl Pyrrolidone; Styrene; Ammonia; Hydroxyethylacrylate;

Allylamine - were investigated). It was found that the most suitable one is allylamine since it allows to significantly increase the permeability of the textile without impacting the pore size: a critical flux (J_{crit}) up to 215 LMH could be achieved.

Since the performance of the nanocomposite textile was promising, a study concerning the scale-up of its production processes and the related costs was carried out. The main issue related to this kind of membrane is the scale-up of the electrospinning process from lab-scale to industrial-scale. However, industrial electrospinning equipments are commercially available. TTX contacted one of the most important producer (ELMARCO, Czech Republic), and on the basis of the performance and productivity of its equipment it was possible to make an estimation of the production costs for the nylon 6 nanocomposite textiles (Table 26).

Table 25. Estimation of the production costs for the nanocomposite textile

Expenditure	Cost	Cost [€/m²]
<i>Material</i>		<i>0.024</i>
Nylon 6	2.00 €/kg	0.007
Formic Acid	0.65 €/kg	0.017
<i>Support Nonwoven</i>	3.87 €/m²	<i>3.870</i>
<i>Investment*</i>	600,000	<i>1.151</i>
<i>Energy</i>	0.13 €/kWh	<i>0.044</i>
TOTAL		5.132

* 5 year depreciation

The membranes set-up within AMEDEUS allow to save around 9 €/m² compared with a commercial PVDF membrane that has a total cost of 14 €/m² (cost reduction rate 63%).

11.3 Use of Flux Enhancers - Flocculants

As pore sizes of textiles are slightly larger than those of conventional microfiltration membranes (Table 24); the smaller flocs in the biomass do not just agglomerate in a dense filter cake but are also able to penetrate the porous structure of the textile and cause pore clogging and low quality permeate. Experiments with flocculated sludge were therefore conducted in the filtration test cell shown in Figure 56 by the University of Technology, Berlin (Iversen et al., 2009b – for further information concerning the working mechanisms of the flocculants see Iversen et al. 2008b and Section 1). With flocculants, the TMP decreased to negligible values (due to the high permeability of the textile). During filtration trials of 12h, it was found to be favourable to regularly allow sufficient time for re-flocculation of the sludge (i.e. reduction of shear stress due to pumping, aeration). Under these conditions, stable operation (Figure 56) of the filtration system was possible over several hours with a flux of 55 L/(m²h). While the permeate was visibly clear, hygienic examination after 12 h showed that the number of colony forming units (CFU) was in the range of 8000/mL for the coarse Novatexx nonwoven and in the range of 3000-4000 for the nanocomposite textile. This does not meet the requirements of the EU bathing directive and is much higher than the 2 CFU/mL measured in the permeate of the MF membrane.

According to the promising results achieved with the nanocomposite membrane and with flocculation, A3 constructed three different textile modules: one realised with the Novatexx 2431N membrane with nano-coating, one realised with the Novatexx 2471N membrane with nano-coating and the latter realised just using the virgin Novatexx 2431N membrane. The characteristics of the textile modules are listed in Table 26.

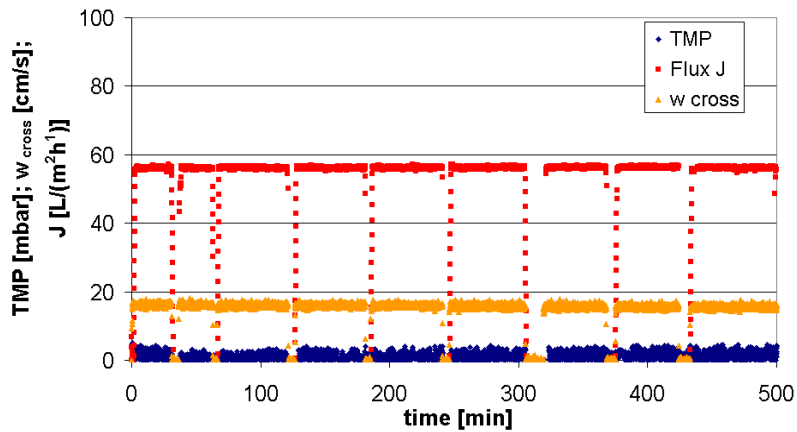



Figure 56. Stable operation if re-flocculation is applied

Table 26. Characteristic of the Textile MBR modules

Textile BioReactor (TBR)		
Number of plates per unit	8	
Membrane per plate	2	
Membrane dimension [m ²]	0.10x0.15	
Total Filtration Area [m ²]	0.24	

The filtration tests were performed by TUB with the sludge originating from the AMEDEUS pilot plant operated within WP2 on the premises of a pumping station in Berlin city center (see Figure 3). The system was fed twice a day with synthetic wastewater according to DIN EN ISO 11733 in a quantity to ensure similar sludge load as in the pilot system. The module was operated in a filtration/relaxation modus of 8min/2min.

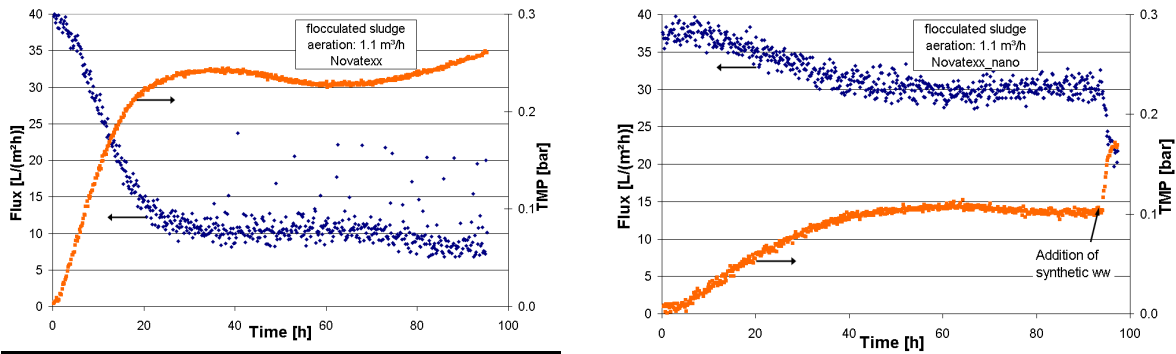

Figure 57. Filtration performance of the coarse nonwoven Novatexx and the nanocoated Novatexx during pilot scale operation

The filtration with the nanocoated textile Novatexx seemed to be more stable and sustainable than the filtration with the coarse nonwoven Novatexx as can be seen in Figure 57. The smaller pores were probably not easily penetrated by sludge flocs and seemed to be less susceptible to fouling. For both textile modules, the best performance was found for the medium aeration of 1.1 m³/h. For the lower aeration the cake was obviously not removed effectively, and at an aeration of 5 m³/h the shear stress was probably too high, leading to smaller sludge flocs and segregation in terms of particle size on the textile surface. Nevertheless, the permeate quality was not as good as with microfiltration, with 650-750 CFU/mL in the beginning and 200-460 after 5 days (Iversen et al., 2009b).

Furthermore, it was demonstrated that the cleaning of the textile membranes was possible even if conventional textile and nanocomposite showed a different behaviour. The permeability of the nonwoven was recovered by approx. 90% by the physical cleaning step, so fouling was only on the surface and could be easily removed. On the contrary, recovery after the physical cleaning was below 20% for the nanocomposite textile; here the chemical cleaning step was essential to have a sufficient cleaning that means that fouling seemed to be more persistent. The significant –and contradictory- difference of recovery after physical cleaning between nonwoven and nanocomposite textile could not be fully explained.

11.4 Conclusion

The characterisation of nonwovens showed that they have limitations for application in MBR: larger pore sizes with a large pore distribution. In order to easily solve the limits of the textile filtration media, electrospinning combined with plasma treatment seems to be a promising option. The coating of nanoweb and the functionalisation by means of plasma treatments allows reducing some critical points, such as porosity and roughness mainly responsible for the low filtration performances. Furthermore, plasma is able to enhance the permeability of treated membrane because of the reduction of the superficial tension.

Concerning the critical flux measurements it was found that a combination of flocculants and textile shows promising results if large flocs can be sustained. Best results were achieved with flocculated sludge and the virgin nonwoven or the nanocomposite membrane. The similarity in size of flocs and pores seems to be detrimental for the operation of textile bioreactors (TBR). During long term operation of a TBR, the nanocoated material showed better results than the coarse nonwoven delivered by Freudenberg. The filtration performance with flocculant was not as good as during the test cell trials, which might be due to hydrodynamic differences between the test cell and the bioreactor. It was possible to operate the nanocoated module at a flux of 30L/(m²h) for 3d. The test cell trials indicate that fluxes up to 150 L/(m²h) might be possible. Further studies are necessary for better scaling-up of the process. Investigations of the number of bacteria in the permeate showed that these decrease with time due to the build up of the filter cake. The high standard of MBR effluent was however not reached within the 5 days operation time.

Further research is necessary in the field of permeability recovery by physical / chemical cleaning, as fouling and cleaning phenomena might strongly differ from conventional microporous membranes.

12 Objective 12. Development of turn-key standardised MBR plants and filtration units.

12.1 Introduction

One way to reduce the production costs of MBR plants, especially for small plants produced and sold in large numbers, may be to develop a range of standardised plants with fixed sizes, membrane surfaces and reactor volumes. Such plants may be produced in series, and as containerised turn-key solutions, may be ideal for small decentralised applications (50 to 2,000 pe). For larger applications, up to 10,000 p.e., a range of standardised plants for filtration unit only could be developed. These filtration units could be easily implemented, also as turn-key solution, in case of plant retrofitting, or could be used together with an external biological reactor in case of new plants. In the AMEDEUS project, the Czech company Envi-Pur developed engineering concepts for such ranges of standardised MBR plants and filtration units, using the module technology among those offered by the other industrial partners.

12.2 Design of a range of MBR units

12.2.1 Concept and design hypothesis

The decision was taken to engineer the units with the MBR modules of A3 Water Solutions, partner of AMEDEUS offering the most mature and commercial technology. In a second step, some thoughts were done with regards to the type of containers and pre-treatment. It was decided to use either standardised ISO steel containers (10 ft and 20 ft) and plastic containers from the Envi-pur production. The ISO containers will be mostly sold to foreign countries contrary to plastic containers which are developed to be sold mainly in the Czech Republic. Small engineering differences will result from the use of plastic or ISO containers. The rotary screen of Czech company Vodatech was also selected as pre-treatment, after comparison of the market offer. These screens will be used only for bigger installations above 200 pe. In a third step, the range of flow capacity was determined (Table 27), as well as the corresponding reactor volumes. It was decided to design four possible sizes of MBR containers according to population equivalent (50, 100, 200 and 500 pe). Systems of larger size up to 2,000 pe would be achieved by combining several smaller systems. Corresponding technical drawings were prepared including ground plan, cross section and list of the fittings and equipment. In a fourth step, the filtration system was engineered based on recommendations provided by the company A3 Water Solutions (Table 29).

The design hypotheses were as follows:

- Specific wastewater production of 150 L/PE/day
- Up to 5% of ballast water (infiltration of groundwater to sewerage system)
- Coefficients k_d (daily inequality) and k_h (hourly inequality) typical of the concerned size to calculate peak daily flow ($Q_{d,max}$) and peak hourly flow ($Q_{h,max}$).
- Wastewater concentration and load as specified in Table 28

Table 27. Design parameters (for ISO containers)

PE	50	100	200	500	
Specific product. Of WW	150	150	150	150	[L/PE/day]
Daily production of WW	7.5	15	30	75	[m ³ /day]
Balast water	5	5	5	5	%
Q_d	7.9	15.8	31.5	78.8	[m ³ /day]
K_d	1.5	1.5	1.5	1.5	
$Q_{d,max}$	11.6	23.3	46.5	116.3	[m ³ /day]
K_h	6.7	5.9	5.2	2.6	
$Q_{h,max}$	3.2	5.6	9.8	12.3	[m ³ /h]

Table 28. Design pollution

	BOD	COD	SS	N-total	P-total	
Loading	60	120	55	10	2,5	g/PE/day
Concentration	381	762	349	63	16	mg/L

Table 29. Design parameters of membrane modules

PE	50	100	200	500	
Net flux	12	11	11	11,5	[LMH]
Filtration area	40,4	88,1	176,1	421,2	[m ²]
Membrane modules	2x20	70+20	2x70 2x20	6x70	(A3 water solution)
Real filtration area	40	90	180	420	[m ²]
Membrane aeration	0,7	0,7	0,7	0,7	[Nm ³ /m ² .h]
Air volume	28,3	61,6	123,3	294,8	[Nm ³ /h]

12.2.2 Flow diagram of units and 3D picture

Figure 58 illustrates a typical flow diagram of a containerised unit, and Figure 59 shows a 3D picture of the system.

The wastewater is pumped to the pre-treatment facility (buffer tank aerated with coarse bubble for mixing, optionally with screen), the denitrification tank with a grounding pump. The denitrification tank is linked to the nitrification tank by the gap at the bottom of the tank. The activated sludge is circulated from the nitrification tank to the denitrification tank by the recirculation pump with a recirculation ratio equal from one to five. The recirculation pump is also used for withdrawing the surplus sludge if the sludge concentration exceeds 18 g/L. For the 400 PE and 500 PE containers, additional sludge treatment may be provided.

At least two membrane modules are included in the activated sludge tank for parallel operation. The membrane modules are aerated for fouling control. The activated sludge tank is separately aerated with a fine bubbles aeration system.

Part of the extracted permeate is stored in the cleaning tank where the membrane modules are cleaned with addition of cleaning chemicals. Defoaming chemicals are applied manually in case of foam occurrence.

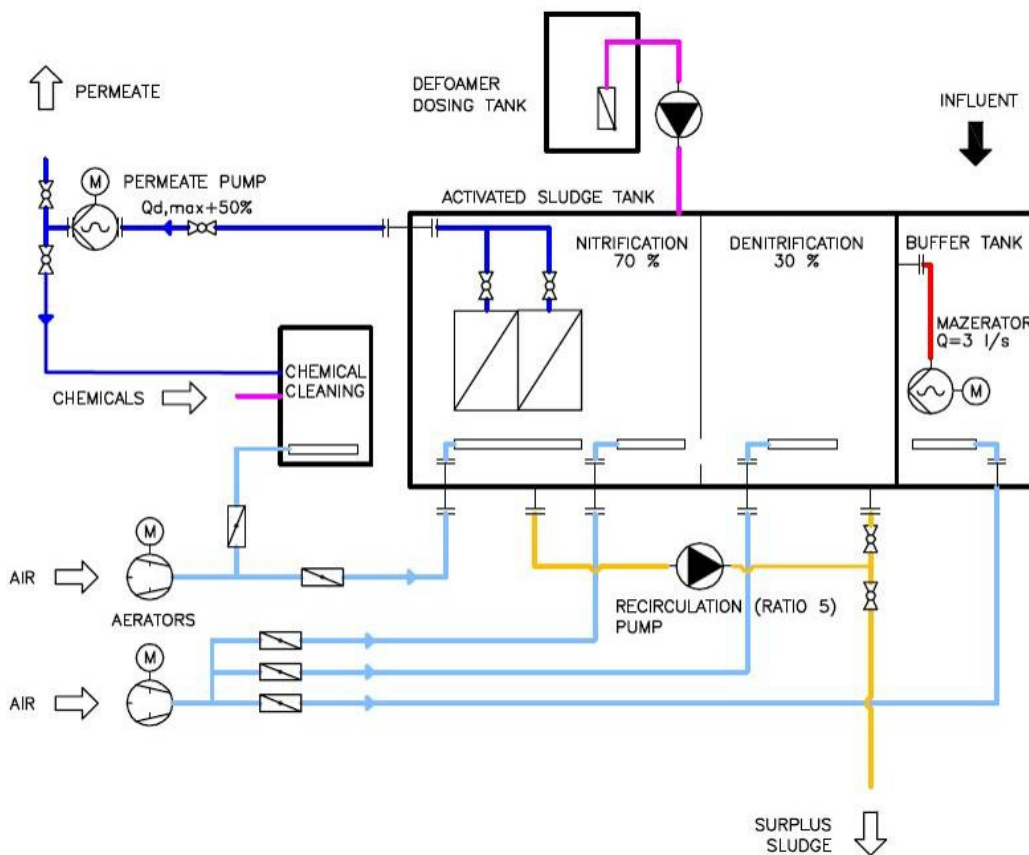

Figure 58. Flow diagram of containerised WWTP

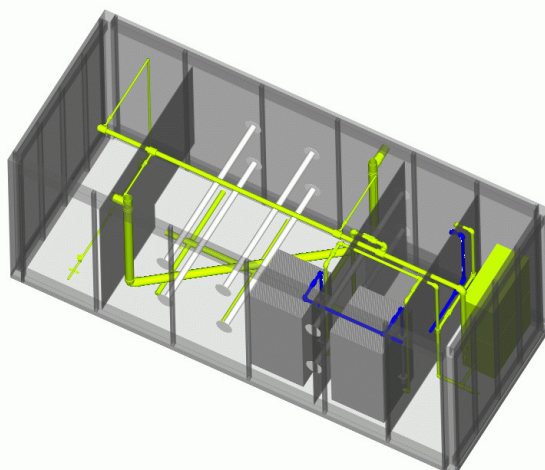

Figure 59. 3D picture of containerised system (200 pe)

12.2.3 Large filtration units

Larger filtration units up to 2,000 p.e. were designed for upgrading existing plants. Cost estimations were performed to assess the feasibility of retrofitting a wastewater treatment plant of 1,000 pe, compared with the building of a new complete membrane system (MBR) or hybrid MBR-CAS process.

In order to give a broader overview of different configurations costs, five cases were considered in this comparison (Table 30):

- The building of a complete new conventional system (Envi-Pur experience)
- The building of a complete new MBR (based on the Vasserveld MBR case)
- The building of an hybrid system treating only a part of the dry weather flow (based on Oostmarsum MBR case)
- The retrofitting of the existing plant with a membrane filtration step treating the complete flow
- The retrofitting of the existing plant with a membrane filtration step treating the dry weather flow combined with a buffer capacity addition.

Table 30. Cost comparison of the different membrane options (estimation in Euros) for the retrofitting of wwtp of 1000 p.e. (DWF 125 m3/d)

	new CAS	%	New MBR	%	Hybrid	%	Retrofit RWF	%	Retrofit DWF+buffer T	%
Pretreatment	5000	2%	15000	4%	15000	6%	15000	5%	15000	7%
Biology-civil parts	80000	39%	120000	34%	80000	32%				
Mechanical parts	65000	32%	65000	19%	45000	18%	65000	23%	45000	20%
Electronic parts	55000	27%	50000	14%	40000	16%	50000	18%	40000	18%
Membrane			100000	29%	60000	24%	100000	36%	60000	27%
Extra work					10000	4%	50000	18%	60000	27%
Total cost (Euros)	205000	1.00	350000	1.71	250000	1.22	280000	1.37	220000	1.07

The optimal solution seems to couple the membrane with a well defined buffer capacity. By treating most of the inflow (dry weather flow for instance) through the membrane, the effluent quality can be largely improved and the membrane cost significantly reduced. The extra inflow can thus be treated during low loading periods (at night for instance). With the rough cost estimation, this option seems to allow a cost saving of 40-55% compared to a complete new MBR process in accordance with cost estimations of Aquafin for larger scale MBR plants built under hybrid-dual configuration (see Section 8).

12.3 Operation of the units

The bioreactors will be operated with a high sludge age (SRT > 30 days), and a low sludge load of about 0.06 kgMLSS/kgBOD₅.d with a maximum sludge concentration 15 kg/m³ and a net flux of membrane modules at 10-15 l/h.m².

The wastewater treatment plants will be operated without permanent staff. For smaller systems, regular control on a weekly basis is recommended. The operation of the 400 and 500 pe units will require in average 2 h/day. The control unit can be equipped by GSM module for remote control.

The chemical cleaning of the membrane modules occurs in dedicated cleaning tanks for the plastic container versions. The module is taken out by a crane installed on the top of the container and moved to the cleaning tank. One cleaning tank is included in the ISO container unit versions. The transportation of the module is done by the crane too.

12.4 Prototype

A prototype of a containerised WWTP with membrane separation was constructed. Basic calculated capacity was 50 pe (population equivalent), with expectations that the system can cope with a capacity up to 100 pe (see Figure 60 and Figure 61).



Figure 60. Plant overview



Figure 61. Mechanical pre-treatment

13 Objective 13. Results integration.

13.1 Introduction

A dedicated objective of AMEDEUS was to prepare and facilitate the commercialisation or exploitation of the project technologies and developments while enhancing the penetration of the MBR technologies in new European markets. Several initiatives were conducted to address this objective:

1. An analysis of the European MBR market at the start and the end of the project was performed, with a focus on the largest plants (the greater share of the market)
2. Results were “integrated” within AMEDEUS, and also with the project Euombra and the other projects of the coalition of European projects MBR-Network through six “Liaison Groups” (LG) addressing selected topics
3. The project developments were regularly reviewed and compared with current patents: any patentable innovation was detected and the partners were encouraged to protect the know-how.

13.2 Analysis of the European MBR market

Objectives

The Berlin Centre of Competence for Water performed a market survey of the MBR technology in Europe and the Middle-East by the end of the year 2005, complemented 3 years later to observe the evolution and trends of the market. The market study was thought to compile an exhaustive and detailed database of all MBR units constructed in order to provide a snap-shot of the market with regards to the countries, to the installed capacity, and to the different MBR technologies commercially available. The complete inventory of all MBR plants with an installed capacity greater than 20 m³/d for industrial applications and 100 m³/d for municipal applications (i.e. roughly > 500 p.e.) was performed (Lesjean et al., 2008a, for the 2005 status and Huisjes et al., 2009, for the 2008 status). In addition, a more detailed study on the 37 MBR plants built up by the end of the year 2008 with a capacity greater than 5,000 m³/d was carried out (Lesjean et al., 2009).

Materials & Methods

The market study was performed while contacting all companies supplying MBR modules in the European and Middle-East market, and the market analysis was performed only with this “product source” perspective; i.e. the other contributors in the overall MBR market were not accounted for (consultants, plant designers and constructors, operators etc).

Results and discussion

The main results of the MBR market survey are as follows:

- By the end of the year 2008, about 800 MBR plants of the considered size were commissioned in Europe, of which 566 were built up for industrial applications and 229 for municipal applications (Figure 62), for a total installed capacity reaching in 2008 the threshold of 1,000 MLD. The wastewater of about 2 millions of citizen is handled by MBR treatment, i.e. about only 0.5% of the European population.
- The annual market volume has been steady in the past 5 years for the industrial sector with about 65 new references per year, demonstrating the maturity of the MBR technology for the industrial market. In contrary, the municipal market really kicked off in 2002 with an increasing volume since then: 30 new references per year were inventoried in the years 2004-2005, and 45 in the years 2007-2008, highlighting that the market has not reached full maturity yet.
- The size of municipal MBR units is about one order of magnitude greater than the size of systems for industrial applications (Figure 63): the core 60% of the industrial MBR references (20-80% cumulated repartition) are in the range 60-600 m³/d, whereas the equivalent range for municipal applications lies within 200-5,000 m³/d (i.e. about 1,000 to 20,000 p.e.), without any significant evolution of the size repartition in the last decade.

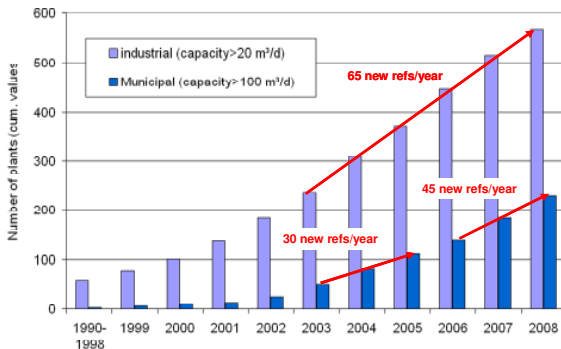

Figure 62. Evolution of MBR market in Europe

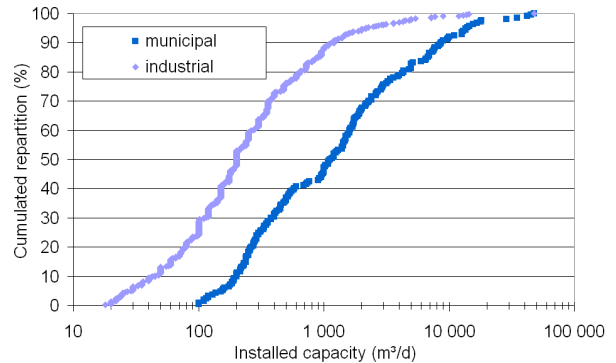

Figure 63. Capacity distribution of European MBR plants

- Consequently, the municipal sector drives the MBR market in terms of capacity and installed membrane surface: if the municipal market represented already approximately 2/3 of the total installed capacity in 2004-2005, it covered about 3/4 of the market in the years 2007-2008. Alone the eleven larger municipal MBR plants (> 5,000 m³/d) which were commissioned during this same period contributed to more than half of the total installed capacity across the entire market.
- The countries leading the European MBR market in terms of reference numbers are Italy, Germany, United Kingdom, Spain, France and The Netherlands, the most dynamic countries being currently Spain followed by Italy who have together doubled their parks of MBR units in the past 3 years, in particular through the sudden development of water reuse projects (Figure 64).
- The MBR technology is also a competitive technology for upgrade or refurbishment of existing wastewater treatment plants: one third of the municipal applications, whatever the considered size, refer to retrofitting project using existing infrastructure.
- Key industrial applications are food industry, landfill leachate, cleaning / textile / laundry wastewater, and wastewater treatment aboard ships. The larger industrial applications are found in the petrochemical sector and also for processing of water from sludge treatment.
- The Middle-East market showed a step increase in the last 2 years with 44 new plants (from a total of 66 inventoried by the end of 2008). It is characterised by an extreme concentration on the municipal market with the construction of very large plants: as an example, when commissioned in 2009, the plant of Jumeirah Golf Estates (United Arab Emirates), will be the larger MBR plant worldwide with a total installed capacity of 269,000 m³/d.

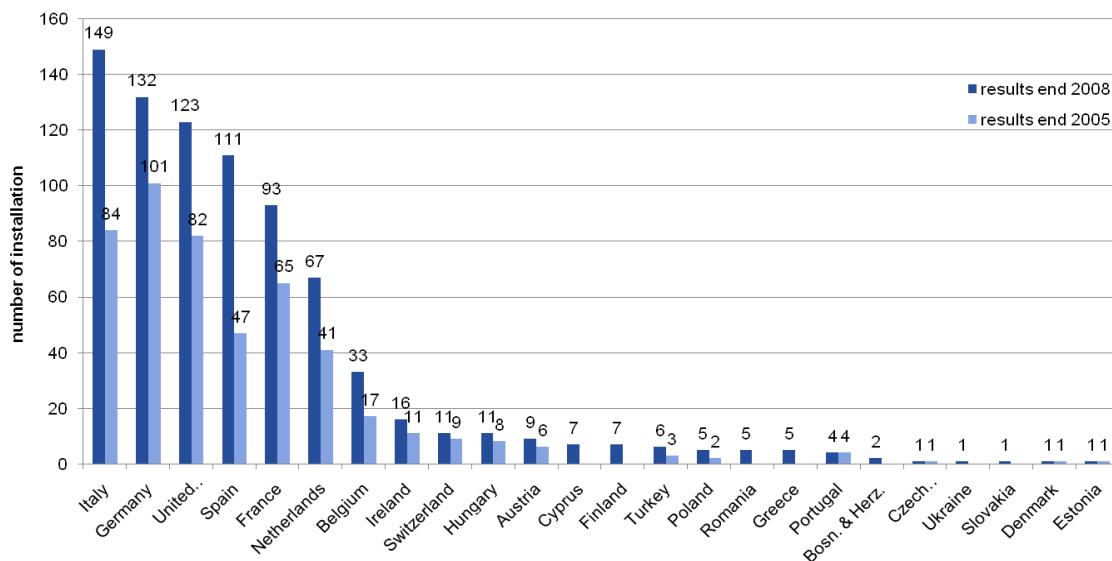

Figure 64. Geographical distribution of MBR market in Europe

Conclusions

Since the development of the submerged MBR technology, and its commercial deployment in the first years of the new millennium, the European MBR market has witnessed a growth rate greater than 10% per annum. This growth was driven essentially by the municipal sector, and in particular by the construction of the larger plants with an installed capacity above 5,000 m³/d. In contrast, the industrial market is very mature and competitive, and exhibits a constant market volume with about 65 new plants being constructed per year in the past 5 years.

The MBR technology is now a cost competitive option for industrial wastewater treatment, or for municipal projects with exceptional specifications such as enhanced water quality (for bathing water, water reuse), reduced footprint or upgrade of existing plants. Following the

observed trend in countries such as Spain, Italy, or Cyprus, the technology is expected to be embraced in the coming years by other European countries facing water-scarcity such as Greece, Croatia, Turkey etc.

13.3 Results integration

The integration of the results was first performed at the project level between workpackages. Among others, the following “knowledge transfer” or “cross-seeding” occurred between work packages and partners:

- The operation of the A3 MBR systems by AR fed TUB and VITO for their own pilot trials with the same system
- The experience with flux enhancers acquired by TUB could be transferred to the nonwoven textile MBR process developed by TTX
- The 3 MBR technologies developed were evaluated by ENVI for the engineering of the containerised units
- The modelling experience of AQF supported AR with the evaluation of their results regarding the model calibration and the interpretation of the systems with or without primary clarifier
- The VFM sensor developed by VITO was implemented at pilot scale to assess advanced process control
- The tracing method developed by UNSW could be applied to the pilot units of AR (used for biological modelling) and also to the Schilde plant operated by AQF
- A CFD approach of TUB was applied to the Schilde plant

In order to facilitate an efficient and “real time” integration of the results between the 28 partner of the projects AMEDEUS and EUROMBRA and the partners of the other MBR-Network projects, six “Liaison Groups” (LG) were created to foster the exchange and discussions between partners and external specialists on selected topics.

During the course of the project, the partners met therefore in several occasions, most of the time close to conferences or yearly meetings, to review the technical outcomes of the studies. Minutes, reports and / or book of handouts of these meetings were often produced on the website www.mbr-network.eu. This resulted in many co-operations, joint investigations when they were meaningful and joint publications or disseminations of the results. For example, one peer review of biological modelling practices with MBR was performed by several authors originating from the 3 projects AMEDEUS, EUROMBRA and MBR-Train, one fellow of MBR-Train assessed one method of fouling indicator in a “European tour” around MBR plants operated by partners of the 3 projects, and also cross-comparison of filterability assessment methods developed between the 3 projects were carried out. The network of projects proved to be particularly beneficial in terms of capacity building for the many PhD-students and post-doctorates involved in the research programs who could take advantage of the opportunities of contacts and discussions with numerous seniors and experts.

LG1 ‘Fouling’:

- 2-day MBR-Network Workshop ‘Biofouling in membrane systems’, 11-12 July 2006, Trondheim
- 2-day meeting on fouling, 6-7 December 2007, Toulouse

LG2 ‘Cleaning’:

- 11 October 2006, Maisons-Laffitte, France Review of activities, coordination of next actions
- 29 Oct. 2007, Aachen Membrane & Water Conference, Review of activities, coordination of next actions

LG3 'Filtrations systems':

- 11 October 2006, Maisons-Laffitte, France: issue of filtration systems from pilot to full scale
- 29 Oct. 2007, Aachen Membrane & Water Conference, Feed-back on CFD, A3 & KMS concepts

LG4 'Process configuration':

- 29 Sept. 2007, Trento « Inside / Outside » configurations

LG5 'Modelling':

- 3 June 2007, Berlin, 1st workshop on CFD for MBR
- 2 April 2008, Delft, Netherlands, workshop on biological modelling of MBR
- 14 July 2008, Gent, 2nd workshop on CFD for MBR

LG6 'Retrofitting':

- 1 September 2008, Gelsissen, Germany, meeting on "retrofitting with MBR"

In addition to these specific meetings, the two projects AMEDEUS and EUROMBRA have performed a joint (crossed) mid-term evaluation which occurred on 13-14 May 2007 just before the IWA conference on membrane technologies of Harrogate, UK. This event was the unique opportunity for all partners of the AMEDEUS and EUROMBRA projects to present their progress and to review their results. Ms. Cora Uijterlinde (project coordinator/ research manager, STOWA, the Netherlands) and Mr. Detlef Wedi (independent consultant, Germany) acted as independent evaluators and produced as well a detailed review of the two projects. The recommendations of the joint mid-term evaluation were followed to improve the work program of the second term. In addition, potential collaborations and synergies could be identified between the project partners.

13.4 Results protection

The partners of the AMEDEUS project reviewed the project development and results on a regular basis, under the supervision of the WP leaders, the project coordinator and the IP manager, and performed patent searches when any potential innovation was detected. Any patentable invention was systematically identified and proposed for patent. The partners were encouraged to take relevant actions to protect the know-how. The project resulted in total to the production of eleven identified "exploitable knowledge", and no less than 4 patents were filed. The corresponding publishable results are presented in Section 18 of the present report.

14 Objective 14. Dissemination.

14.1 Introduction

One objective of the project AMEDEUS, together with the other FP6 projects of the coalition MBR-Network dedicated to further development of the MBR technology, was to extensively and jointly disseminate the project results while contributing actively to knowledge transfer and information on the MBR technology among decision-makers, market players and other stakeholders in Europe.

14.2 Joint dissemination activities with MBR-Network projects

Dissemination activities were jointly planned and organised with the three other FP6 projects of the coalition of projects MBR-Network (projects EUROMBRA, MBR-Train and PURATREAT).

All internal and external communication or dissemination activities were performed under MBR-Network Cluster corporate identity (logo, presentation template, report template), acknowledging the support of the European Commission. Project flyers and posters were printed out and displayed in major MBR events of all continents. Overview articles to present the Cluster were written and published (Lesjean et al., 2006 a-c, 2007 and 2008b).

The following joint press-releases were distributed in English, German and Dutch, and appeared in at least 20 vectors each (high impact rate).

- October 2005: *Promotion of Novel Waste Water Technologies by the EU. 6 Mio € EU-Funding for Development of Membrane Bioreactor Technology.*
- July 2006: *Launch of "www.mbr-network.eu", the webplatform dedicated to the MBR technology*
- October 2006: *European initiative for the standardisation of membrane bioreactor technology*
- March 2007: announcement of the 2nd IWA National Young Water Professionals Conference in Berlin, Germany
- April 2007: MBR-Network to present first results in international conferences (schedule of dissemination activities in 2007)
- October 2007: One year "www.mbr-network.eu", the webplatform dedicated to the MBR technology
- August 2008: Final workshop of European projects coalition "MBR-Network": 1st announcement and call for posters
- November 2008: Final workshop of European projects coalition "MBR-Network": Final programme
- End 2009: Completion of European projects "MBR-Network"

In addition, the projects AMEDEUS and EUROMBRA have jointly organised the following public workshops and conferences, among which 3 of them targeting new potential market countries in Europe (Portugal, Czech Republic, Greece), and one in Australia:

- 2-day MBR-Network Workshop 'Biofouling in membrane systems', 11-12 July 2006, Trondheim, Norway
- CEN Workshop, 24 November 2006, Berlin, Germany
- 2-day IWA National Young Water Professionals Conference 'Membrane technologies for wastewater treatment and reuse', 4-5 June 2006, Berlin, Germany
- AMW 2007: Aachen Membrane & Water Conference, 1/2 day MBR-Network workshop, 30-31 October 2007, Aachen, Germany
- IMSTEC 2007, 1 day MBR-Network workshop, 5-9 November 2007, Sydney, Australia
- EWM 2008: MBR-Network workshop "Engineering with MBR" during conference "Engineering with membrane", 24 May 2008, Algarve, Portugal
- MBR-Network workshop "Retrofitting of Municipal WWTPs with Membrane Bioreactor Technology - Concepts and Case Studies" coorganised with the German Water Association at the occasion of the official opening of the MBR-Plant Glessen (1 September 2008, Bergheim, Germany)
- MBR-Network workshop "Design with MBR and containerised units – Demonstration Cases", before the ARDEC conference, 1 October 2008, Velke Belovice, Czech Republic.
- MBR-Network workshop "Membrane technologies for alternative water resources", 5 March 2009, Thessaloniki, Greece).
- Final MBR-Network workshop "Salient outcomes of the European projects on MBR technology" (IWA specialised conference), 31 March-1 April 2009, Berlin, Germany.

In total, about 900 delegates and speakers attended these events, with more than 220 participants solely for the Final MBR-Network workshop in Berlin.



Figure 65: MBR-Network workshop in Velke Belovice, Czech Republic (1 October 2008)



Figure 66: Final MBR-Network workshop. Right: poster award winners and international jury

Many proceedings and books of handouts of the workshops and events organised by the MBR-Network coalition were prepared and published on-line on www.mbr-network.eu. In addition, the project partners communicated extensively on the project results in national and international conferences but also in peer reviewed journals (see the selection of the most relevant publications of the project AMEDEUS in Section 16 “Project related publications”).

14.3 Internet platform for the European MBR community

The website www.mbr-network.eu, launched in 2006 and designed and edited by the Berlin Centre of Competence for Water, provides a common entry port to both projects AMEDEUS and EUROMBRA for internal and external communication. The website hosts information on the MBR-Network projects, both static project presentation and dynamic information such as reports, articles, news and events. Since January 2006, the Berlin Centre of Competence for Water has performed a monthly “literature scan” which enabled to identify and upload all references published in the literature (specialised journals and conferences) related to the MBR technology. In addition, any new information (report, event, message in the MBR-Forum) is automatically communicated to the registered members of the webportal. The website is therefore well frequented and highly dynamic, as best illustrated by the frequentation statistics for the month of April 2009, when the proceedings and the books of handouts of the final MBR-Network workshop were posted on-line (Figure 67).

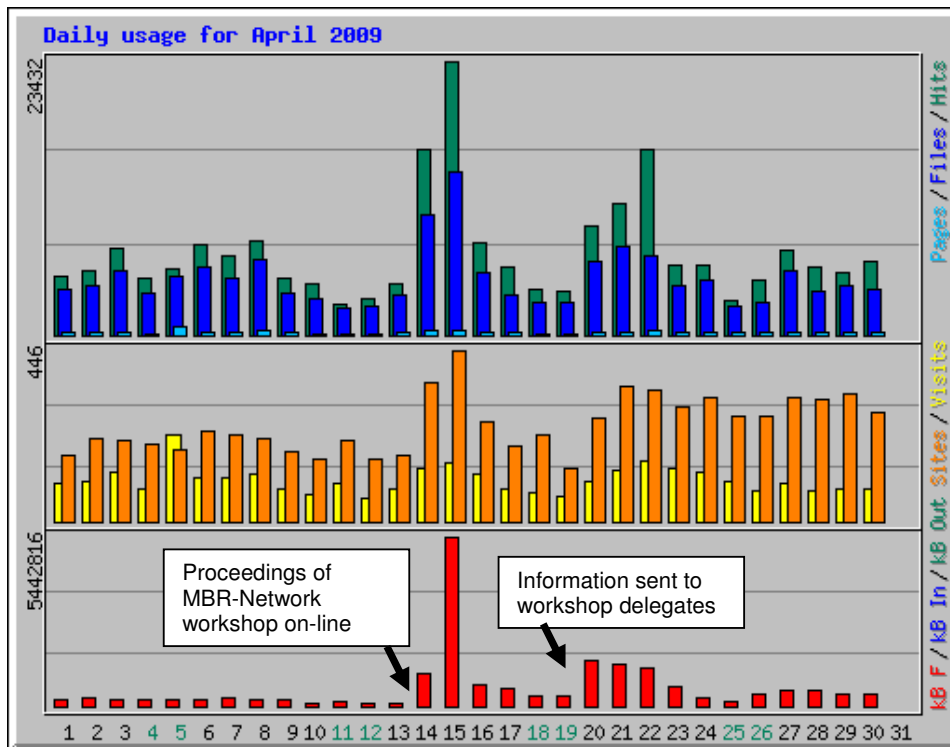

Figure 67. Frequentation statistics of www.mbr-network.eu in April 2009.

The following data present the major statistics of the website:

- In August 2009, after about 3 years of operation, **1090 international professionals** were members of “MBR-Network”, with a steady growth of about **25 new members per month**, including 155 companies or institutions.
- **More than 70 countries are represented**, the countries counting most members being Germany, USA, India, Spain, Australia (50 to 120 members each), followed by The Netherlands, China, United Kingdom, Italy, France and Belgium (30 to 40 members each).
- Since its launch, the website has hosted about **80,000 visits and about 180,000 pages** were viewed (Figure 68). Today, 5,000 to 7,000 pages are regularly consulted on a monthly basis.
- Between the two projects AMEDEUS and EUROMBRA, **11 workshop proceedings and/or books of handouts, 6 reports and 10 articles** were made available on the website by August 2009. They were consulted more than 20,000 times since the website start-up in June 2006. All public reports of the two projects will be available by the end of the year 2009.
- **More than 1200 references of articles** related to MBR technology (journals or conferences) are available in the “literature database”, which were in total consulted about 40,000 times (i.e. in average about 30 times per reference).

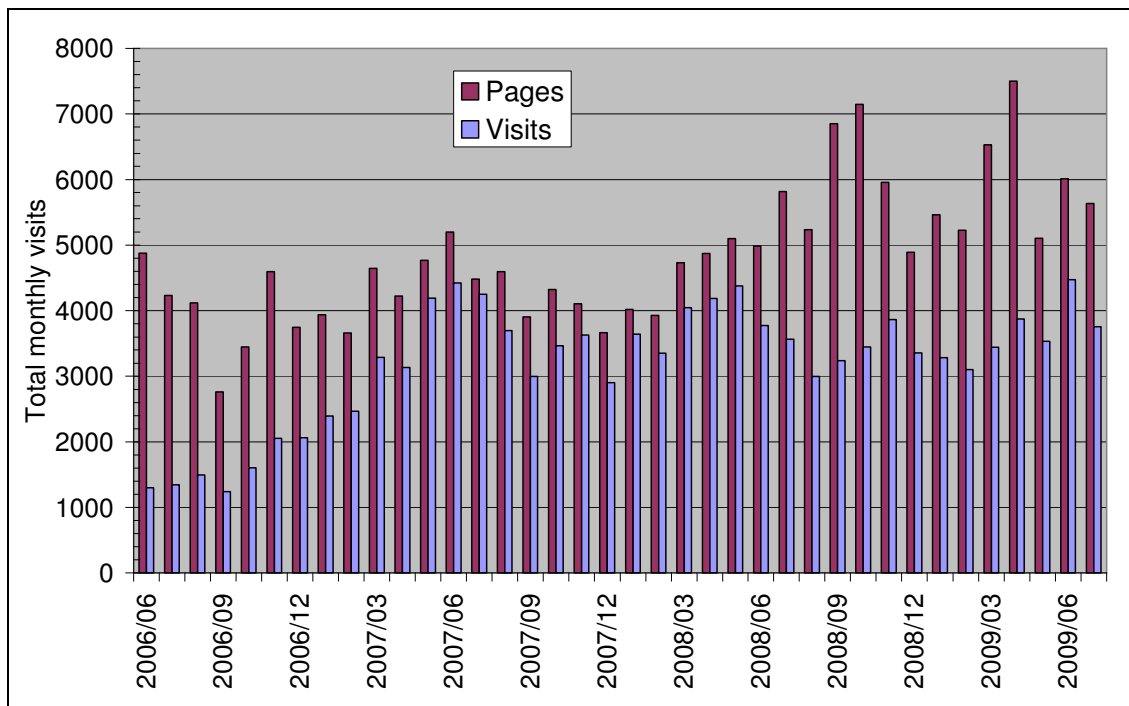

Figure 68. Evolution of total monthly visits and consulted pages of MBR-Network

14.4 Conclusion

The MBR-Network projects performed extensive communication of the project results and supported the construction of a network of expertise on the MBR technology within Europe. The various initiatives undertaken (in particular the common visual identity, the joint press-releases, the numerous workshops and the web-platform) were very efficient in touching a broad public of water and membrane professionals. The website www.mbr-network.eu has proven to be a powerful and sustainable communication tool and source of information for the international MBR community, and will be maintained to play this role after termination of the projects.

15 Bibliographic references

- Aquino S.F., Chernicharo C.A.L., Soares H., Takemoto S. Y. and Vazoller F., (2008) Methodologies for determining the bioavailability and biodegradability of sludges. *Environmental Technology* (29) 855-862.
- Brepols, C. 2008. Personal communication.
- Brepols, C., Schäfer, H. and Engelhardt, N. 2005. Hinweise zur verfahrenstechnischen Integration getauchter Membranfilter in kommunalen Membranbelebungsanlagen. KA – Abwasser, Abfall 52, 1, pp. 45-50
- Brow, P. 2007. Ballyclare MBR WwTW: the cost and challenges of compliance with stringent standards. International Conference on Membranes for Water and Wastewater Treatment, 15-17 May 2007, Harrogate, UK
- CEN Workshop Agreement CEN/WS/34 N 47, 2008, Submerged Membrane Bioreactor (MBR) Technology
- Chang, W.-K., Hu, A.Y.-J. Horng, R.-Y. and Tzou, W.-Y. 2007. Membrane bioreactor with nonwoven fabrics as solid-liquid separation media for wastewater treatment. *Desalination*, 202, 1-3, pp. 122-128
- De Wever, H., Brannock, M., Leslie, G. and Lesjean, B. 2008. Inside or outside submerged membrane bioreactors: parameters and trends. Proceedings IWA regional conference: Membrane technologies in water and waste water treatment, 02-04/06/2008, Moscow (Russia) - p. 232-235, IWA, London (UK)
- De Wilde W., Richard M., Lesjean B., Tazi-Pain A., 2007. Towards standardisation of MBR technology?, Final Report, AMEDEUS, 121 p., ISBN 978-3-9811684-1-9
- Dubois M., Gilles K.A., Hamilton J.K., Rebers P.A., Smith F.S. (1956). Colorimetric method for determination of sugars and related substances. *Anal. Chem.*, 28(3), 350-356.
- Ekama G.A., Söttemann S.W., Wentzel M.C. (2006) Biodegradability of activated sludge organics under anaerobic conditions. *Water SA Vol. 32 No 3* pp 287-296.
- Espinosa M. (2005), Contribution to the study of a Submerged Membrane Bioreactor: Impact of module configuration and aeration conditions on particulate fouling and modelling of biological activity. PhD thesis, INSA Toulouse, pp 239.
- Frechen, F.-B., Schier, W. and Linden, C. 2007. Pretreatment of municipal MBR applications. International Conference on Membranes for Water and Wastewater Treatment, 15-17 May 2007, Harrogate, UK
- Fuchs, W., Resch, C., Kernstock, M., Mayer, M., Schoeberl, P. and Braun, R. 2005. Influence of operational conditions on the performance of a mesh filter activated sludge process. *Water Research* 39, 5, pp. 803-810
- Huisjes E., Colombel K., Lesjean B. 2009. The European MBR market: specificities and future trends. Final MBR-Network workshop "Salient outcomes of the European projects on MBR technology", 31 March-1 April 2009, Berlin, Germany.
- Huyskens, C., Brauns, E., Van Hoof, E. De Wever, H. 2008. A new method for the evaluation of the reversible and irreversible fouling propensity of MBR mixed liquor. *Journal of Membrane Science*, 323, 1, pp. 185-192
- Iversen, V., Drews, A., Schmidt, T., Lesjean, B., Fatarella, E. and Kraume, M. 2007a. Textile Filtermedien für den Einsatz in Membranbelebungsanlagen. *Chemie Ingenieur Technik* 79, 11, pp. 1945-1950
- Iversen, V., Drews, A., Schaller, J., Lesjean, B. and Kraume, M. 2007b. Verringerung des Foulings in Membranbelebungsanlagen durch Zugabe von Filtrationshilfsmitteln. *Chemie Ingenieur Technik* 79, 1, pp. 1951-1957
- Iversen, V., Mohaupt, J., Drews, A., Kraume, M. and Lesjean, B. 2008a. Side effects of flux enhancing chemicals in membrane bioreactors (MBRs): study on their biological toxicity and their residual fouling propensity. *Water Science and Technology* 57, 1, pp.117-123
- Iversen, V., Villwock, J., de la Torre Gacia, T., Drews, A. and Kraume, M. 2008b. Impact of flux enhancer for MBR on floc size distribution, dewaterability and shear stability. Conference on

- membranes in drinking water production and waste water treatment, 20-22 October 2008, Toulouse, France
- Iversen, V., Koseoglu, H., Yigit, N.O., Drews, A., Kitis, M., Lesjean, B. and Kraume, M. 2009a. Impacts of membrane flux enhancers on activated sludge respiration and nutrient removal in MBRs. *Water Research* 43, 3, pp. 822-830
- Iversen, V., Hermann, S., Drews, A., Münz, J., Götz, G., Fatarella, E., Lesjean, B. and Kraume, M. 2009b. Textiles for the filtration of activated sludge in membrane bioreactors (MBR). *Filtech*, 13-15 October 2009, Wiesbaden, Germany
- Iversen, V., Mehrez, R., Horng, R.Y., Chen, C.H., Meng, F., Drews, A., Lesjean, B., Ernst, M., Jekel, M. and Kraume, M. 2009c. Fouling mitigation through flocculants and adsorbents addition in membrane bioreactors: comparing lab and pilot studies. *Journal of Membrane Science* (accepted)
- Ji, J., Qui, J., Wong, F.-S. and Li, Y. 2008. Enhancement of filterability in MBR achieved by improvement of supernatant and floc characteristics via filter aids addition. *Water Research* 42, 14, pp.3611-3622
- Jiang T. (2007), Characterization and modelling of soluble microbial products in membrane bioreactors, PhD thesis, Ghent University, Belgium pp 241.
- Judd, S. 2006. *The MBR book: Principles and applications of membrane bioreactors in water and wastewater treatment*, Elsevier, Oxford, UK
- Judd, S. 2007. Membrane bioreactors: state of the art. AWA Membranes Specialty Conference II, February 21-23, Melbourne
- Koseoglu, H. Yigit, N. O., Iversen, V., Drews, A., Kitis, M., Lesjean, B. and Kraume, M. 2008. Effects of several different flux enhancing chemicals on filterability and fouling reduction of membrane bioreactors (MBR) mixed liquors. *Journal of Membrane Science*, 320, 1-2, pp 57-64
- Lapidou C.S., Rittmann B.E., (2002) A unified theory for extracellular polymeric substances, soluble microbial products, and active and inert biomass. *Water Research* 36 pp 2711-2720.
- Lee, W.-N., Chang, I.-S., Hwang, B.-K., Park, P.-K., Lee, C.-H. and Huang, X. 2007. Changes in biofilm architecture with addition of membrane fouling reducer in a membrane bioreactor. *Process Biochemistry* 42, 4, pp. 655-661
- Lenahan C.E., Barnett N.W., Lewis S.W.(2002). Sequential Injection Analysis; *Analysts*, 127, 997-1020.
- Lesjean B. (2006a) EU Fördert Membran-Technologie, Interview. *Wasserwirtschaft Wassertechnik (WWT)*, June 2006.
- Lesjean B., Leiknes T.O., Hochstrat R., Schories G., Gonzales-Gonzales A. (2006b). MBR: Technology gets timely EU cash boost. *Filtration + Separation*, Nov. 2006, pp. 20-23.
- Lesjean B., Leiknes T.O. (2006c). EC investment promises further advances in MBR technology, *Water Wastewater International*, Nov. 2006.
- Lesjean B. and Leiknes T.O. MBR-Network (2007). a European initiative to boost the development of the MBR technology. IMSTEC07 conference, 5-9 November 2007, Sydney, Australia
- Lesjean B. and Huisjes E.H. (2008a). Survey of European MBR market, trends and perspectives. *Desalination* 231 (2008) 71–81.
- Lesjean B., Leiknes T., De Wever H. (2008b). Presentation and salient results of MBR-Network: the coalition of EU projects dedicated to the MBR technology. IWA Regional Conference – Membrane Technologies in Water and Waste Water Treatment, 2-4 June 2008, Moscow, Russia.
- Lesjean B., Ferre V., Vonghia E., Mosslang H. Market and design considerations of the 37 larger MBR plants in Europe. *Desalination and Water Treatment*. Vol. 6 (2009) 227-233.
- Lesouef A., Payraudeau M., Rogalla F. and Kleiber B., (1992) Optimizing nitrogen removal reactor configurations by onsite calibration of the IAWPRC Activated sludge model. *Water Science and Technology* 25 (6) 105-123.
- Lowry O.H., Rosebrough N.J., Farr A.L., Randall R.J. (1951). Protein measurement with the folin phenol reagent. *J. Biol. Chem.*, 198, 265-275.
- Manser R., Gujer W., Siegrist H., (2005) Consequences of mass transfer effects on the kinetics of nitrifiers, *Water Research* 39 4633-4642.
- Massé A., Spérandio M., Cabassud C., (2006) Comparison of sludge characteristics and performance of a submerged membrane bioreactor and an activated sludge process at high solids retention time. *Water Research* 40 2405-2415

- Munz, G., Gori, R., Mori, G. and Lubello, C. 2007. Powdered activated carbon and membrane bioreactors (MBRPAC) for tannery wastewaters treatment: long term effect on biological and filtration process performance. *Desalination* 207, 1-3, pp. 349-360
- Nopens, I., Batstone, D.J., Copp, J.B., Jeppson, U., Volcke, E., Alex, J., Vanrolleghem, P.A. (2009) An ASM/ADM interface for dynamic plant-wide simulation. *Water Research*.
- Remy, M., van der Marel, P., Zwijnenburg, A., Rulkens, W. and Timmik, H. 2009. Low dose powdered activated carbon addition at high sludge retention times to reduce fouling in membrane bioreactors. *Water Research* 43, 2, 345-350
- Rosenberger, S., Drews, A. and Kraume, M. 2001. Comparison of microfiltration behaviour of activated sludge and model suspensions in a novel membrane test cell. *Chemie Ingenieur Technik* 73, 6, p. 597
- Rosenberger S., Laabs C., Lesjean B., Gnirss R., Amy G., Jekel M. and Schrotter J.-C. (2006). Impact of colloidal and soluble organic material on membrane performance in membrane bioreactors for municipal wastewater treatment. *Wat. Res.*, 40(4), 710-720.
- Ruzicka J., Hansen E. H. (1988). *Flow Injection Analysis*. Wiley, New York, 2nd edn.
- Spérandio M., Massé A., Espinosa M.C. and Cabassud C., (2005) Characterization of sludge structure and activity in submerged membrane bioreactor. *Water Science and technology*, 52 (10-11) 401-408.
- Spérandio M., Espinosa M.C., (2008) Modelling an aerobic submerged membrane bioreactor with ASM models on a large range of sludge retention time. *Desalination* 231 (1-3) 82-90.
- Bratby, J. 2006. Coagulation and flocculation in water and wastewater treatment, IWA Publishing, London, UK, pp. 280-293
- STOWA 2006. Onderzoek MBR Varsseveld, report 2006-6, STOWA, Zwijndrecht, The Netherlands
- Tao, G., Kekre, K., Wei, Z., Lee, T.C., Viswanath, B. and Seah, H. 2005. Membrane bioreactors for water reclamation. *Water Science and Technology* 51, 6-7, pp. 431-440
- van Bentem, A.G.N., Petri, C.P., Schyns, P.F.T. and van der Roest, H.F. 2007. Membrane bioreactors. Operation and results of an MBR wastewater treatment plant. STOWA report, IWA Publishing, London, UK
- Villwock, J., Iversen, V., Drews, A., Lesjean, B. and Kraume, M. 2009. Combination of Flux Enhancers for MBR. Final MBR-Network Workshop, 31 March – 1 May 2009, Berlin, Germany
- Wedi, D. and Joss, A. 2007 Dimensioning of membrane bioreactors for municipal wastewater treatment. International Conference on Membranes for Water and Wastewater Treatment, 15-17 May 2007, Harrogate, UK
- Yasui H., Goel R., Li Y.Y., Noike T., (2008) Modified ADM1 structure for modelling municipal primary sludge hydrolysis. *Water Research* 42 pp249-259.
- Ying, Z. and Ping, G. 2006. Effect of powdered activated carbon dosage on retarding membrane fouling in MBR. *Separation and Purification Technology*, 52, 1, pp. 154-160
- Yoon, S.-H. and Collins, J.H. 2006. A novel flux enhancing method for membrane bioreactors (MBR) process using polymer. *Desalination*, 191, 1-3, pp. 52-61

16 Project related publications (selection)

- Bixio D., De Wilde W., Nenov V., Eliades P., Lesjean B., Thoeye C., Potential of innovative Dual CAS-MBR configurations in two very diverse market situations: Bulgaria and Cyprus. *Water Practice and Technology*, Vol. 3, issue 2, 2008.
- De Wilde W., Richard M., Lesjean B., Tazi-Pain A. (2007). Towards standardisation of MBR technology?, Final Report, AMEDEUS, 121 p., ISBN 978-3-9811684-1-9
- De Wilde W., Richard M., Lesjean B. and Tazi-Pain A. (2008). Towards standardisation of the MBR technology ? *Desalination* 231 (1-3) 156-165.
- M. Ernst, R. Mehrez, A. Drews, V. Iversen, M. Kraume, M. Jekel, Continuous measurement and control of fouling active compounds in membrane bioreactor systems, *Water Sci. Technol.* 56(7) (2007) 11-19.
- Grélot A., Tazi-Pain A., Weinrich L., Lesjean B., Grasmick A. (2009). Evaluation of a novel flat sheet MBR filtration system. *Desalination* 236, 111-119.
- Grélot A., Machinal C., Drouet K., Tazi-Pain A., Schrotter J.C, Grasmick A., Grinwis S. (2008). In the search of alternative cleaning solutions for MBR plants. *Water Science & Technology* 58(10), 2041-2049.
- Grélot A., Busnot A., Grelier P., Tazi-Pain A., Heijnen M., Grasmick A. (2009). A new and appropriate fibre sheet configuration for MBR technologies. *Desalination and Water Treatment* 6, 25-32.
- Grélot A., Grelier P., Vincelet C., Brüss U., Grasmick A. (2010). Fouling characterisation of a PVDF membrane. *Desalination*, 250, 707-711.
- Grélot A., Grelier P., Tazi-Pain A., Lesjean B., Brüss Ulrich, Grasmick A. (2009). Performances and fouling control of a flat sheet membrane in a MBR pilot-plant. 5th IWA Specialised Membrane Technology Conference for Water and Wastewater treatment, Beijing, 1-3 September 2009.
- Huyskens, C., Brauns, E., Van Hoof, E. De Wever, H. 2008. A new method for the evaluation of the reversible and irreversible fouling propensity of MBR mixed liquor. *J. Mem. Sci.*, 323, 1, pp. 185-192
- Iversen, V., Drews, A., Schmidt, T., Lesjean, B., Fatarella, E. and Kraume, M. 2007a. Textile Filtermedien für den Einsatz in Membranbelebungsanlagen. *Chemie Ingenieur Technik* 79, 11, pp. 1945-1950
- Iversen, V., Drews, A., Schaller, J., Lesjean, B. and Kraume, M. 2007b. Verringerung des Foulings in Membranbelebungsanlagen durch Zugabe von Filtrationshilfsmitteln. *Chemie Ingenieur Technik* 79, 1, pp. 1951-1957
- Iversen, V., Mohaupt, J., Drews, A., Kraume, M. and Lesjean, B. 2008. Side effects of flux enhancing chemicals in membrane bioreactors (MBRs): study on their biological toxicity and their residual fouling propensity. *Water Science and Technology* 57, 1, pp.117-123
- Iversen, V., Koseoglu, H., Yigit, N.O., Drews, A., Kitis, M., Lesjean, B. and Kraume, M. 2009a. Impacts of membrane flux enhancers on activated sludge respiration and nutrient removal in MBRs. *Water Research* 43, 3, pp. 822-830
- Iversen, V., Hermann, S., Drews, A., Münz, J., Götz, G., Fatarella, E., Lesjean, B. and Kraume, M. 2009b. Textiles for the filtration of activated sludge in membrane bioreactors (MBR). *Filtech*, 13-15 October 2009, Wiesbaden, Germany
- Iversen, V., Mehrez, R., Horng, R.Y., Chen, C.H., Meng, F., Drews, A., Lesjean, B., Ernst, M., Jekel, M. and Kraume, M. 2009c. Fouling mitigation through flocculants and adsorbents addition in membrane bioreactors: comparing lab and pilot studies. *J. Mem. Sci.* (in press).
- Jimenez J., Grelier P., Meinhold J., Tazi-Pain A. 2009. Biological modelling of MBR and impact of primary sedimentation. *Desalination* (in press)
- Koseoglu, H. Yigit, N. O., Iversen, V., Drews, A., Kitis, M., Lesjean, B. and Kraume, M. 2008. Effects of several different flux enhancing chemicals on filterability and fouling reduction of membrane bioreactors (MBR) mixed liquors. *Journal of Membrane Science*, 320, 1-2, pp 57-64
- Lesjean B., Leiknes T.O., Hochstrat R., Schories G., Gonzales-Gonzales A. 2006. MBR: Technology gets timely EU cash boost. *Filtration + Separation*, Nov. 2006, pp. 20-23.
- Lesjean B., Editor of proceedings of 2nd IWA National Young Water Professionals Conference "Membrane Technologies for Wastewater Treatment and Reuse", 4-5 June, 2007, Berlin, Germany, ISBN 978-3-9811684-0-2, May 2007.

- Lesjean B. and Huisjes E.H. Survey of European MBR market, trends and perspectives. *Desalination* 231 (2008) 71–81.
- Lesjean B., Ferre V., Vonghia E., Mosslang H. Market and design considerations of the 37 larger MBR plants in Europe. *Desalination and Water Treatment*. Vol. 6 (2009) 227-233.
- Mehrez R., Jekel M., Ernst, M. (2007,a). Sample pre-treatment device for continuous EPS analysis in membrane bioreactor systems. IWA Young Researchers Conference, Berlin June 4-6 2007.
- Lesjean B., Leiknes T.O. 2009. Editors of proceedings of Final MBR-Network Workshop “Salient outcomes of the European R&D projects on MBR Technology”. 31 March - 1 April 2009, Berlin, Germany. ISBN 978-3-9811684-5-7.
- Mehrez R., Ernst, M., Jekel M. (2007,b). Development of a continuous protein and polysaccharide measurement method by Sequential Injection Analysis for the application in membrane bioreactor systems. *Wat. Sci. Technol.*, 56 (6), 163-171.
- Weinrich L. and Grélot A. (2007). Evaluation of innovative operation concept for flat sheet MBR filtration system. *Water Science and Technology* 57 (4), 613-620.

17 Public project reports

Despite the present final report, the following public project reports are available on the MBR-Network website: www.mbr-network.eu.

- D7 Final report of WP1 – Nonwoven textile for MBR filtration
- D12b Final report WP2 – MBR fouling control strategies and on-line sensors of fouling indicators
- D19 Evaluation of a novel MBR filtration technology from A3 Water Solutions
- D24 Final report WP3 – Development of innovative MBR technologies and optimised cleanings
- D25 White paper on MBR standardisation in Europe
(De Wilde W., Richard M., Lesjean B., Tazi-Pain A. (2007). Towards standardisation of MBR technology?, Final Report, AMEDEUS, 121 p., ISBN 978-3-9811684-1-9)
- D31 Final report WP5 – Biological modelling of MBR and impact of primary sedimentation
- D38 Final report WP6 – Implementation of submerged module inside or outside of reactor
- D46 Final report WP7 – Design of a range of containerised and standardised MBR plants
- D51 Final report WP8 – Advanced data acquisition, supervision and control system for MBR
- D53 Evaluation report of the (optimised) flow repartition control strategy results of a full-scale CAS-MBR Dual 1 concept (MBR Schilde)
- D53b Report on hydrodynamic modelling of WWTP Schilde and design / operation recommendation
- D55 Review report of typical WWTPs in targeted countries
- D58 Final report of WP9 – Design and control of dual MBR configurations for plant refurbishment

Lesjean B. 2007. Editor of proceedings of 2nd IWA National Young Water Professionals Conference “Membrane Technologies for Wastewater Treatment and Reuse”, 4-5 June, 2007, Berlin, Germany, ISBN 978-3-9811684-0-2, May 2007.

Lesjean B., Leiknes T.O. 2009. Editors of proceedings of Final MBR-Network Workshop “Salient outcomes of the European R&D projects on MBR Technology”. 31 March - 1 April 2009, Berlin, Germany. ISBN 978-3-9811684-5-7.

Please refer to the present report as:

AMEDEUS project final report, ISBN: 978-3-9811684-6-4, 2009, 120 pages.

18 Publishable results

18.1 Nanocomposite Membranes

- Result description:
A novel nanocomposite membrane were realised by deposition of randomly oriented nanofibers onto conventional nonwoven support. It was found that the application of the nanofiber layer enabling to overcome the limitations that can be found when conventional textile filter media (basically nonwovens). In fact, the closer structure of the nanofibrous layer is responsible for the reduction of the pore size up to 0.6 μm and of the roughness up to 1.1 μm (values comparable with conventional microfiltration membranes) by ensuring high critical flux, up to 75 MLH (typical value for conventional membranes is 25 MLH).
- Possible market applications or use in further research:
 - o Liquid Filtration or Air Filtration systems
 - o Medical Textiles
- Stage of development:
Test were only performed at lab-scale even if the feasibility of the production process at large-scale was demonstrated. In any case, further investigations and developments are required in order to optimise the adhesion of the nanolayer to the support.
- Collaboration sought or offered:
 - o Improvement of the adhesion of the nanolayer to the textile support
 - o Development/selection of specific textile supports
 - o Demonstration of the production process on pilot/industrial scale.
- Collaborator details:
Textile support providers in order to investigate the possibility to produce support specific for this applications.
- Intellectual property rights:
An Italian Patent BO2008A000197 has been submitted in March 28th 2008.
- Contact details:
Enrico Fatarella
Next Technology Tecnotessile Società di Ricerca rl.
Via del Gelso, 13 Prato (Italy)
chemtech@tecnotex.it
Tel. +39 0574 634040

18.2 Systematic investigation on chemical additives as flux enhancers

- Result description:
Membrane fouling still is a major cost factor in MBR technology. In addition to traditional fouling mitigation strategies like air scour etc., the promising method of adding certain chemicals to the MBR mixed liquor has recently emerged. These additives modify mixed liquor properties such as floc size and SMP (soluble microbial products) concentration. Several additives like natural and synthetic polymers, metal salts, activated carbons and others come into question for this task.

- Possible market applications or use in further research:
Solid / liquid filtration in bioreactors

- Stage of development:
A systematic comparison of different potential flux enhancers, considering also side effects, has been accomplished within the project. A large number of substances was screened in lab trials considering their impact on SMP removal, particle size distribution and fouling propensity of the sludge as well as biotoxicity. The most promising chemicals were investigated in long term trials in two parallel pilot plants fed on real municipal sewage.

- Collaboration sought or offered:
Identification and development of further flux enhancing substances with polymer and chemical companies.

- Intellectual property rights:
None.

- Contact details:
Prof. Matthias Kraume
Technische Universität Berlin
Institut für Verfahrenstechnik
Sekt. MA 5-7
Straße des 17. Juni 136
10623 Berlin
Matthias.Kraume@TU-Berlin.de
fon: +49 (0) 31 423 701
fax: +49 (0)30 314 72756

18.3 Combination of textile membrane and flocculant

- Result description:
Textile filtration media generally have much larger pore sizes than conventional membranes (5-100µm for textiles vs. 0.01-0.5µm for membranes). These pores can be easily penetrated by the sludge causing a low permeate quality or fouling in the textile. As sludge flocs are normally negatively charged the addition of multivalent cations can lead to larger flocs, which can then be retained by the textile. Lower fouling and a better permeate quality can thus be achieved.

- Possible market applications or use in further research:
Solid / liquid Filtration in bioreactors

- Stage of development:
Promising pre-tests were performed at lab-scale. Further investigation and development are required in order to verify the results for long-term and large-scale operation.

- Collaboration sought or offered:
Contract agreement for further developments.

- Intellectual property rights:
None

- Contact details:
Prof. Matthias Kraume

Technische Universität Berlin
Institut für Verfahrenstechnik
Sekt. MA 5-7
Straße des 17. Juni 136
10623 Berlin
Matthias.Kraume@TU-Berlin.de
fon: +49 (0) 31 423 701
fax: +49 (0)30 314 72756

18.4 Containerised MBR plant (<500 PE)

- Result description:
Containerised MBR plant

- Possible market applications or use in further research:
Municipal and industrial waste water treatment

- Stage of development:
Model construction

- Contact details:
Daniel Vilím
ENVI-PUR, Ltd.
Company domicile: Mesicka 3083, 390 02 Tabor, Czech Republic
Office: Wilsonova 420, 392 01 Sobeslav, Czech Republic
Tel. +420 381 203 226
Fax: +420 381 251 739
Mobile phone: +420 731 629 718
E-mail: vilim@envi-pur.cz
Web: www.envi-pur.com

18.5 Basic Design of middle size MBR plant (>1.000 PE)

- Result description
Basic design of MBR plants bigger than 1,000 population equivalent

- Possible market applications or use in further research:
Municipal and industrial waste water treatment

- Stage of development:
Paper study

- Contact details:
Daniel Vilím
ENVI-PUR, Ltd.
Company domicile: Mesicka 3083, 390 02 Tabor, Czech Republic
Office: Wilsonova 420, 392 01 Sobeslav, Czech Republic
Tel. +420 381 203 226
Fax: +420 381 251 739
Mobile phone: +420 731 629 718
E-mail: vilim@envi-pur.cz
Web: www.envi-pur.com

18.6 On-line analysis of carbohydrates and proteins

- Result description:

Within AMEDEUS a sensor for continuous and on-line measurement of proteins and polysaccharides in mixed liquor of MBR was developed at TUB. Polysaccharides and proteins are understood as foulants that are considered to cause mainly the membrane fouling and lead to productivity decline. Before the development only manually and discontinuously measurement of proteins and polysaccharides were performed, no consistent set of long term data on the evolution of carbohydrates and proteins in the sludge supernatant is available and also their impact on membrane fouling is often contradictory described.

The new on-line sensor can be used for the monitoring of daily and seasonal variations of polysaccharides and proteins concentration, as well as evaluation of their impact on membrane fouling and flux decrease in the MBR reactor. The on-line sensor might be combined with dosing of additives (e.g. flocculants, activated carbon) that were tested at TUB within AMEDEUS as well in order to obtain an effective and less expensive use of such substances (e.g. to reduce protein or polysaccharides in the reactor). The dosing could be dynamic depending on the measured concentrations of carbohydrates and proteins in sludge mixed liquor. Furthermore the equipment for continuous analysis might be very effective tool as an output parameter for advanced control of MBR operation like ACS developed by VITO. Next to MBR applications, the on-line sensor might be applied for process analytic in food, biotechnology or other industries, where these parameters are important to monitor.

- Possible market applications:

- o MBR waste water treatment
- o Process industries (food, biotechnology, ...)

- Stage of development:

Lab prototype.

- Collaboration sought or offered:

The analytical method was not patented and is open for further development and application.

- Intellectual property rights:

None

- Contact details:

Prof. Martin Jekel
Technische Universität Berlin
Chair of Water Quality Control, Sekr. KF4
Straße des 17. Juni 135
D-10623 Berlin, Germany

18.7 Procedure to clean flat sheet membrane by using backwash

- Result description:

The hydraulic operating conditions of the membrane systems have to be optimised to achieve a reliable control of the fouling over the time for minimal energy consumptions. The new cleaning procedure to clean flat sheet membrane by using backwash has shown

to be efficient in MBR applications to maintain membrane performances over the time while reducing the membrane aeration demand. With this new cleaning procedure, the filtration system can cope with fouling due to peak flows and biological stress without carrying out any intensive chemical cleanings. The frequency of the intensive cleanings is therefore reduced too. This cleaning procedure is based on the use of a specific backwash which can be used with flat sheet membrane without damaging them.

- Possible market applications or use in further research:
This cleaning procedure can be applied to flat sheet modules filtering water, wastewater, industrial water or mixed liquor.
- Stage of development
The system has already been tested on a MBR pilot filtration system with the A3 Water Solutions flat sheet technology at the Research Centre of Veolia Water (Anjou Recherche). Further tests will be envisaged by Veolia to verify the mechanical resistance of the membrane on longer time before exploiting the cleaning procedure in his own operation.
- Collaboration sought:
None.
- Intellectual property rights
The intellectual property rights are in the hands of Veolia and are protected by patent (Application number: FR 09/51979, Filing date: 30 March 2009). A3 Water Solutions has been given a free non-exclusive license.
- Contact details:
Aurélie Grélot, Anjou Recherche
Chemin de la Digue, BP76
F-78603 Maisons Laffitte
aurelie.grelot@veolia.com
+33 134938163

18.8 Dual 2 flow scheme

- Result description:
The Dual 2 concept constitutes an innovative flow scheme of a Dual Membrane Bioreactor (MBR) Conventional Activated Sludge (CAS) WWTP. It is a very useful means in reducing the costs for membrane technology. This cost-reduction is achieved in two ways. At first, it shares the advantage of all Dual systems in this sense that the membrane area can be reduced. This is possible because the peak flows are treated by the final clarifier. The membrane filtration tank is thus only designed to treat the average flow. A reduction of the membrane area has serious repercussions on the total investment cost. Secondly, for a Dual 2 treatment scheme, only one aeration tank has to be foreseen. By varying the MLSS concentration in the tank, the treatment capacity is adapted to the varying influent load. Since the average MLSS concentration in the Dual 2 aeration tank is higher than in a CAS system, the volume of this aeration tank is also relatively smaller. The innovation of the Dual 2 scheme lies in the way in which the flow rates are divided between the clarifier and the membrane filtration tank depending on the influent flow and the resulting MLSS concentration in the different compartments.
- Possible market applications or use in further research:
Aquafin is building a full scale WWTP for test purposes. The Dual 2 concept will be further developed and validated in order to formulate clear-cut design rules and operational guidelines.

- Stage of development
Development is in the pre-valorisation and upgrading phase.
- Collaboration sought:
Collaboration with local market developers especially in newly accessed countries or in water scarce countries can benefit the uptake and valorisation of the technology
- Intellectual property rights
The intellectual property rights are in the hands of Aquafin n.v. and are protected by patent (Application number: PCT/EP2006/069543, Filing date: 11 December 2006). The patent has been published on the 14 th of June 2007 under publication number WO2007/065956 A1.
- Contact details:
Wouter De Wilde
Aquafin n.v.
Dijkstraat 8
B-2630 Aartselaar
Email: wouter.dewilde@aquafin.be
Telephone: +32 479 975036

18.9 The MBR-VITO Fouling Measurement system

- Result description:
VITO aimed to develop a fouling measurement method and sensor which is capable of evaluating both the reversible and irreversible fouling propensity of MBR mixed liquor. A module was designed which holds one tubular membrane and which can be placed directly in a MBR or within a separate tank. The MBR-VFM measuring apparatus is a software controlled and fully automatic filtration device which extracts permeate from the sensor while storing all relevant filtration data. The control, data-acquisition by automatic sampling and MBR-VFM related standard calculations are performed within the proprietary software MeFiAS® which was developed at VITO under LabVIEW® and adapted towards the specific set-up. The MBR-VFM uses a specific measurement protocol consisting of alternating filtration and physical cleaning steps, which enables the calculation of both the reversible and the irreversible fouling resistances. The membrane material and measurement protocol can be adapted to be as close as possible to the conditions in the full-scale MBR investigated.
The approach proved to be reproducible and sensitive to most parameters relevant for fouling. Furthermore, the differences measured in reversible and irreversible fouling seemed to relate to the observed impact of physical and chemical cleaning respectively.
- Possible market applications:
Filtration processes in water purification operations.
- Stage of development:
The system has already been tested and proven on a MBR pilot filtration system and is currently under investigation for application on industrial wastewater. The actual MBR-VFM set-up allows for on-line measurements. However, membrane replacement is still performed manually. On the long term, a development towards a fully automated measurement with a fixed sequence of membrane replacements, measurements and membrane cleanings will have to be aimed for. Further developments could be performed towards other mixed liquors, such as those generated by various industrial MBRs.

- Collaboration sought:
Further research should mainly focus on the automation of the system. We foresee to do this together with adequate partners with experience in water monitoring and/or water filtration.
- Collaborator details:
Partners with experience in water monitoring and/or water filtration, both from the academic and industrial sector
- Intellectual property rights:
A worldwide patent was filed in 2008 : WO 2008/132186 (titel: "Supervisory control system and method for membrane cleaning").
- Contact details:
Heleen De Wever
Project Leader
heleen.deweever@vito.be
+32(14)336932

VITO N.V.
Boeretang 200
B-2400 Mol
Belgium
www.vito.be

18.10 Advanced control system for the optimization of (MBR) filtration process parameters (ACS)

- Result description:
The control of the process parameters of a MBR filtration system can be based in practice on a PLC or a PC software oriented control. In both cases the set points of the different operational parameters need to be defined and their value set. Very often, these parameters are fixed at the very start of a new MBR installation and only adapted in a minor way during operation, evidently with the risk of the MBR largely underperforming by providing e.g. needless excess aeration during periods when the fouling potential of the MBR mixed liquor is low. An advanced control system (ACS) was therefore developed and tested which is able to change the values of the set points in an automatic, flexible and more optimized way and which in fact supervises the functioning of the basic control system. The ACS has a user-friendly interface and allows for clear logging of changes in operational conditions.
The system uses input parameters, such as fouling sensor measurements and uses these to generate appropriate set points for the filtration related parameters, such as aeration, relaxation, etc. The main advantages are: online supervision, steering and control, and a more energy efficient filtration process, which may result in more reduced operating costs.
- Possible market applications:
Filtration processes in water purification operations.
- Stage of development:
The system has already been tested and proven on a MBR pilot filtration system and is currently under investigation for application on industrial wastewater.

- Collaboration sought:
Further research lines are the combination with different types of on-line sensors or monitoring mechanisms and the application for other filtration processes. These are required to build up a broad technical platform for a relevant business plan. We foresee several years of additional research together with some adequate partners (with experience in water monitoring and/or water filtration, both from the academic and industrial sector) before being able to establish such a business plan.
- Collaborator details:
Partners with experience in water monitoring and/or water filtration, both from the academic and industrial sector
- Intellectual property rights:
A worldwide patent was filed in 2008 : WO 2008/132186 (titel: "Supervisory control system and method for membrane cleaning").
- Contact details:
Heleen De Wever
Project Leader
heleen.deweever@vito.be
+32(14)336932

VITO N.V.
Boeretang 200
B-2400 Mol
Belgium
www.vito.be

18.11 Production of novel fibre sheet membrane and module for MBR

- Result description:
Membranes have been produced which are characterised in the fact that they consist of a large number of interconnected hollow fibres, which form a flat sheet. These membranes have been fitted in a module and several modules were connected in a system.
- Possible market applications:
Filtration processes in water purification operations.
- Stage of development:
This system was tested in an MBR under relatively standard conditions and a good permeability and low fouling propensity was observed. Some optimisations with regards to membrane stability as well as module development still need to be done.
- Collaboration sought:
In order to further optimise the membrane as well as module and complete system, collaboration could be sought in order to being able to commercialise the product faster.
- Collaborator details:
Partners with experience in Membrane Bioreactor design and build.
- Intellectual property rights:
A patent on the production process for the membrane exists, owned by inge.

- Contact details:
Martin Heijnen
Project Leader
mheijnen@inge.ag
+49 8192 997779

Inge GmbH
Flurstrasse 27
86926 Greifenberg
Germany
www.inge.ag

18.12 Advanced flow splitting algorithm for a combined MBR-CAS treatment plant

- Result description:
In the highly overloaded Dual 1 MBR plant of Schilde a new splitting algorithm between the CAS and MBR lane was developed in order to reach the consents. Based on experimental results the incoming Kjeldahl nitrogen could be fairly estimated by measuring the incoming flow rate, NH₄⁺ and SS. The influent Kj-N in combination with the measured TN removal efficiency for both the MBR and CAS lane yield an estimate of the available and required capacity in the system. Based on this, the flow splitting, aeration set-points and chemical dosing are controlled.
- Possible market applications:
Filtration processes in water purification operations.
- Stage of development:
Various settings of the control strategy were tested on full scale. The use of the control strategy with the optimal set of parameter values was extended beyond the duration of the testing period. Continuous efforts for process optimisation in order to enhance treatment efficiency with the existing infrastructure.
- Collaboration sought:
None in terms of development.
- Intellectual property rights:
Details of knowledge to be used internally by Aquafin.
- Contact details:
Lucas Maes
Aquafin n.v.
Dijkstraat 8
2630 Aartselaar
tel: +32 (0)3 450 41 26
www.aquafin.be

18.13 Development of a Triple deck Module

- Result description:

A triple deck configuration was developed on the basis of A3 M70 Modules. Three of these modules were stacked in a specific guiding system. The triple deck system was produced and tested.

- Possible market applications:

Filtration processes in MBR for waste water treatment.

- Stage of development:

A first triple deck configuration was tested at Seelscheid demonstration site under relatively standard conditions and a good permeability. This system is installed in one MBR unit at Pongs GmbH for treatment of industrial waste water. The installation operates runs stable and efficient.

- Collaboration sought

Not intended.

- Intellectual property rights:

None for triple deck configuration, apart from the previous A3 patent for the modules.

18.14 Development of Modules with larger membrane area

- Result description:

Based on the M70 module design (length 700 x depth 710 mm) a larger module was designed with an membrane area of 90 m² and a length of 1000 mm. The system consists of flat membrane sheets with a thickness of 6 mm by 7 mm distance between the membranes bags. A further design use membrane bags with a thickness of 2,1 mm. This design enabled dimensions form the M70 standard by a larger membrane area.

For testing a module prototype was produced. The tests showed an efficient permeability, but the used membrane was not applicable because of extension and bending in the module.

- Possible market applications:

Filtration processes in MBR for waste water treatment.

- Stage of development:

A first prototype was tested.

- Collaboration sought

Not intended.

- Intellectual property rights:

None.

18.15 Biological model calibration of MBR

- Result description:

Anjou Recherche has developed a Veolia-intern biological model based on the activated sludge model ASM1, and has calibrated this model on a broad range of operation conditions and wastewater type using two pilots.

Concerning MBR modelling, the results of this study show that the model is able to predict correctly MBR performances for pilot fed by two different influents at 15 days sludge age with the same kinetic parameters, the main difference being the pre-treatment impact on bioavailability of substrate from wastewaters.

- Possible market applications or use in further research:

The biological model will be used by the engineering department of Veolia to dimension future wastewater plants and to improve the operation of actual wastewater plants. Phosphorous removal addition will be incorporated in the model.

- Stage of development

The Veolia model has been calibrated and validated on two pilots in Anjou Recherche, fed by different wastewater quality. Phosphorous removal modelling will be calibrated and validated with pilot data.

- Collaboration sought:

None.

- Intellectual property rights

The intellectual property rights are in the hands of Veolia.

- Contact details:

Julie Jimenez, Anjou Recherche
Chemin de la Digue, BP76
F-78603 Maisons Laffitte
julie.jimenez@veolia.com
+33 134938187

18.16 Methodology to identify cleaning products alternative to chlorine

- Result description:

A methodology was developed to test various cleaning reagents on different membrane types (flat sheet, hollow fibre,...). Several protocols and tools were developed by the Membrane expertise Center to foul and clean membranes. This methodology consists in performing first lab-scale tests to select the most promising chemicals among a large variety of products. The effectiveness of these products is then verified on membrane fouled in real conditions and in pilot-plant. The full-scale tests appeared essential to validate the lab-scale tests. With this methodology, it appeared that chlorine remains for instance the most efficient cleaning product for MBR application.

These cleaning tests can be backed up by a full diagnostic of new membranes, after fouling and after cleaning. Results showed that the irreversible fouling composition varied from one membrane to another although they were used in the same conditions. Therefore, the cleaning frequency and strategy is to be adapted to each membrane.

- Possible market applications or use in further research:
This methodology can be used for all membrane types to identify new cleaning reagents. Further research is still needed to develop tests enabling to identify the best cleaning way (with retrofitting, filtration, soaking, time,...).

- Stage of development
This methodology was tested on three different membranes delivered by A3 Water Solutions, Polymem and Inge at the Research Center of Veolia.

- Collaboration sought:
None.

- Intellectual property rights
None.

- Contact details:
Aurélie Grélot, Anjou Recherche
Chemin de la Digue, BP76
F-78603 Maisons Laffitte
aurelie.grelot@veolia.com
+33 134938163

19 Acknowledgement

AMEDEUS is a research project supported by the European Commission under the Sixth Framework Programme (Priority “Global Change and Ecosystems”)

Contract No. 018328 - AMEDEUS

Duration: 01/10/05 – 31/05/09

All European partners of the AMEDEUS project are thankful to the financial contribution of the European Commission.

The undertakings of the University of New South Wales were financed by the Australian Government.

The Berlin Centre of Competence for Water acknowledges the financial contribution of Veolia Water to complement the European financing.

AMEDEUS is part of the MBR-NETWORK Cluster

More info: www.mbr-network.eu

ISBN: 978-3-9811684-6-4

